

CV-905S

VGA & Audio to HDMI Scaler Converter

User Manual



Full HD
1080

WUXGA
× 1920
1200

 **x.v.Color**
 **SINGLE PATENTED**

**7.1 CH
AUDIO**



rev: 131218
Made in Taiwan



Safety and Notice

The **CV-905S VGA & Audio to HDMI Scaler Converter** has been tested for conformance to safety regulations and requirements, and has been certified for international use. However, like all electronic equipments, the **CV-905S** should be used with care. Please read and follow the safety instructions to protect yourself from possible injury and to minimize the risk of damage to the unit.

- Follow all instructions and warnings marked on this unit.
- Do not attempt to service this unit yourself, except where explained in this manual.
- Provide proper ventilation and air circulation and do not use near water.
- Keep objects that might damage the device and assure that the placement of this unit is on a stable surface.
- Use only the power adapter and power cords and connection cables designed for this unit.
- Do not use liquid or aerosol cleaners to clean this unit. Always unplug the power to the device before cleaning.



TABLE OF CONTENTS

INTRODUCTION	1
FEATURES.....	1
PACKAGE CONTENTS.....	1
SPECIFICATIONS.....	2
PANEL DESCRIPTION	3
CONNECTION DIAGRAM	4
OSD MENU	5
OPERATION APPROACH.....	6
LIMITED WARRANTY	10

INTRODUCTION

The **CV-905S VGA & Audio to HDMI Scaler Converter** offers an easy and instant approach for converting analog PC video (VGA) with either digital audio (S/PDIF) or analog stereo audio to digital HDMI. With this module, VGA based devices such as PC with S/PDIF or analog stereo audio can readily connect to your HDMI TV. With such a convenience, presentations, demonstrations, or digital signage become easier and more cost effective.

FEATURES

- IR remote control
- Remote control via Mini-USB
- OSD control interface
- Maximum pixel rate : 165MHz
- S/PDIF & Stereo input supported
- Deinterlacer supported
- Supports noise reduction and video enhancement features
- Over / under scanning adjustable
- Video H/V mirror supported
- Active video area adjustment supported
- USB firmware upgradable for expanding compatibility
- Wall-mount housing design for easy installation

PACKAGE CONTENTS

- 1x CV-905S
- 1x 5V/2A power supply unit
- 1x IR Remote control
- 1x User Manual
- 1x Installation software CD

SPECIFICATIONS

Model Name	CV-905S	
Technical		
Role of usage	VGA to HDMI Converter	
Frequency bandwidth	165MHz	
Audio support	Stereo PCM (48KHz only)	
ESD protection	[1] Human body model — $\pm 19\text{kV}$ [air-gap discharge] & $\pm 12\text{kV}$ [contact discharge] [2] Core chipset — $\pm 2\text{kV}$	
PCB stack-up	4-layer board [impedance control — differential 100Ω ; single 50Ω]	
Firmware update	Feasible via USB Port	
CEC Channel	N/A	
Input TMDS signal	1.2 Volts [peak-to-peak]	
Input DDC signal	5 Volts [peak-to-peak, TTL]	
Input	1x VGA + 1xS/PDIF+ 1xStereo	
Output	1x HDMI	
VGA connector	HD-15 [15-pin D-sub female]	
HDMI connector	HDMI [19-pin female]	
USB connector	Mini B	
Mechanical		
CV-905S		
Housing	Metal enclosure	
Dimensions [L x D x H]	Model	92 x 83 x 28mm [3.6" x 3.3" x 1.1"]
	Package	175 x 128 x 134mm [6.9" x 5" x 5.3"]
	Carton	662 x 366 x 290mm [2'2" x 1'2" x 1']
Weight	Model	260g [9.1oz]
	Package	510g [17.9oz]
Fixedness	Wall-mounting case with screws	
Power supply	5V 2A DC	
Power consumption	5 Watts [max]	
Operation temperature	0~40°C [32~104°F]	
Storage temperature	-20~60°C [-4~140°F]	
Relative humidity	20~90% RH [no condensation]	

PANEL DESCRIPTION

Front Panel

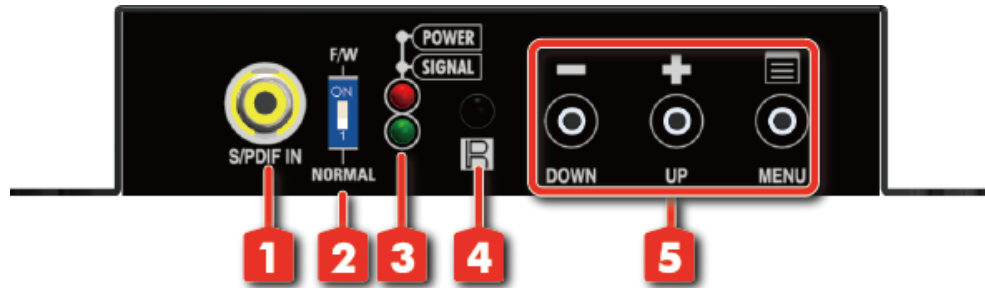

- 1. S/PDIF AUDIO IN:** connect to digital S/PDIF audio source
- 2. DIP SWITCH:** For firmware update
ON [↑]: firmware update mode
OFF [↓]: normal mode
- 3. LED INDICATOR:**
[green]: signal indicator LED
[red]: power indicator LED.
- 4. IR SENSOR:** IR sensor for receiving the IR commands from IR remote
- 5. PUSH BUTTON**
[LEFT]: Down Button
[MID]: Up Button
[RIGHT]: Menu/Enter Button

Rear Panel

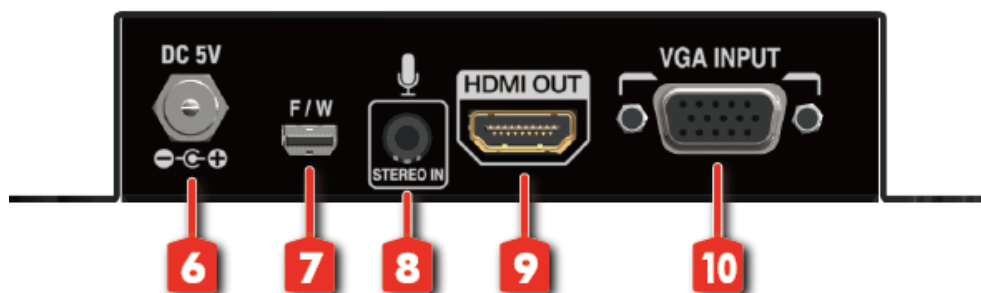

- 6. +5V DC:** Interlocking power jack for 5V DC power supply unit
- 7. Mini USB:** F/W update & control port
- 8. STEREO AUDIO IN:** connect to analog stereo audio source
- 9. HDMI OUT:** Connect to a HDMI display with a HDMI male-male cable here.
- 10. VGA IN:** connect to a VGA source

CONNECTION DIAGRAM

- HDMI
- VGA
- AUDIO
- USB

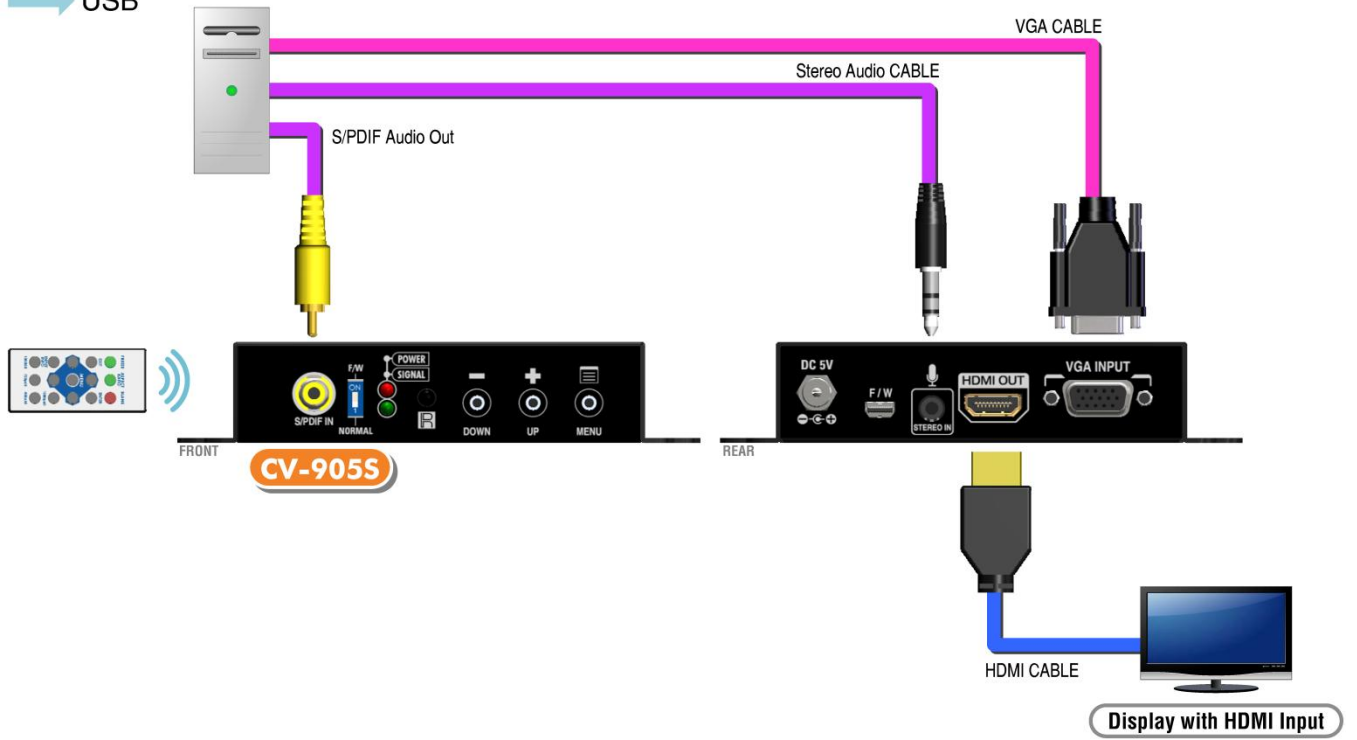

OSD MENU

1. Output Setup	Out Res.	
	Output Mode	RGB, YCbCr444, YCbCr422
	Default Pattern	Disable, White, Cross, Hatch, Color, Gray, Windows, H-Ramp, W-HRamp, W-VRamp, Diagonal
	Audio Source	Stereo, SPDIF
2. Image	Contrast	0~255 of Contrast Level
	Brightness	0~255 of Brightness Level
	Saturation	0~255 of Saturation Level
	Hue	0~255 of Hue Level
	B/W Extension	Off, On
	Color Tone	Off, Skin, Green
	Edge Enhance	Typ, Mid, Max, Off
	Sharpness	0~127 of Sharpness Level
3. Adjustment	Under/Over Scan	-50%~50% of Scan Level
	Aspect Ratio	16:9, 4:3
	H-Mirror	Off, On
	V-Mirror	Off, On
	H-Shift	-100~100 of H-Shift Level
	V-Shift	-50~50 of V-Shift Level
4. System	Input Res. Info	
	Firmware Version	
	Factory Reset	

OPERATION APPROACH

Method A: Push-in Button



Method B: IR Remote Control

Button	Function
FREEZE	Freeze video
ASPECT RATIO	Aspect ratio change
BLANK	Blank video
EXIT	Exit OSD
ENTER	Enter key
UP	Up key
LEFT	Left key
RIGHT	Right key
DOWN	Down key
MENU	Menu on
INPUT INFO	Source resolution information
1080p60	Select 1080p60 output resolution
1080i60	Select 1080i60 output resolution
720p60	Select 720p60 output resolution
480p60	Select 480p60 output resolution

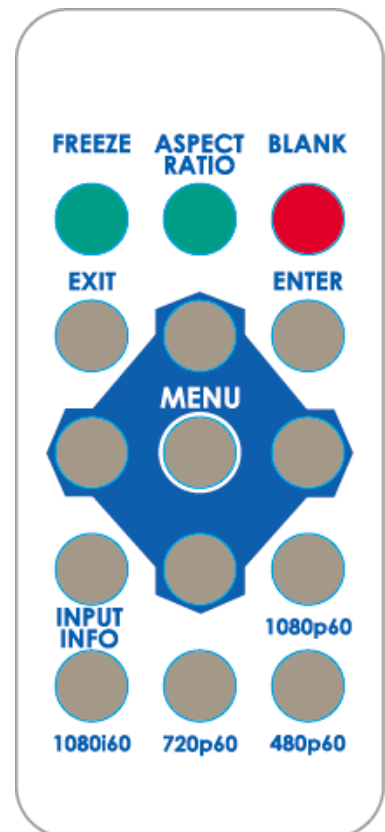

Method C: IR Remote Control through Mini-USB port

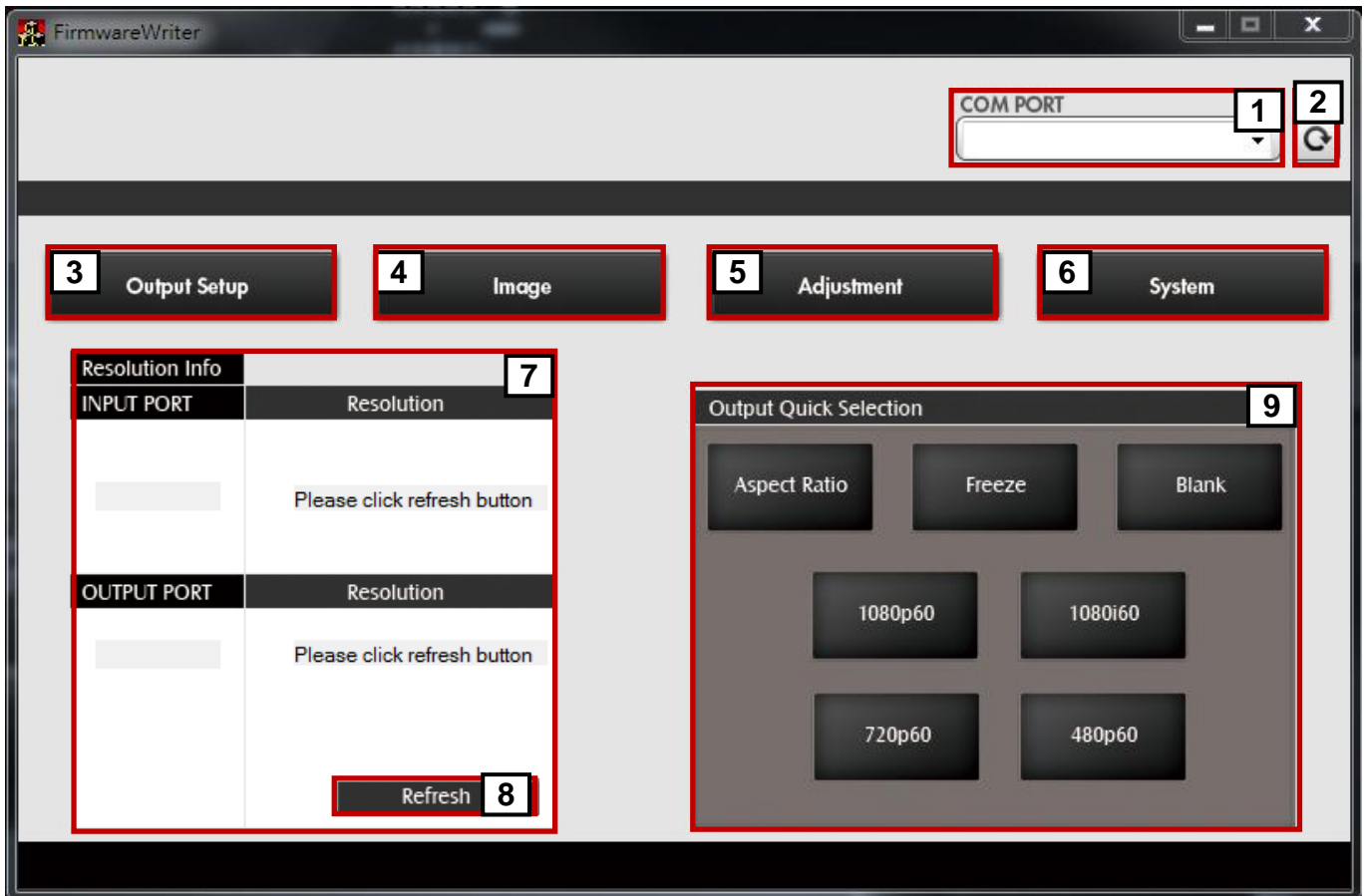

1	COM Port Selection
2	COM Port Detection Button
3	Output Setup Button
4	Image Button
5	Adjustment Button
6	System Button
7	Input / Output Resolution Info
8	Refresh Input / Output Resolution Info Button
9	Output Quick Selection Button

1. COM Port Selection

Please select the application COM PORT



2. COM Port Detection Button

Click this button  to detect the COM PORT

3. Output Setup Button

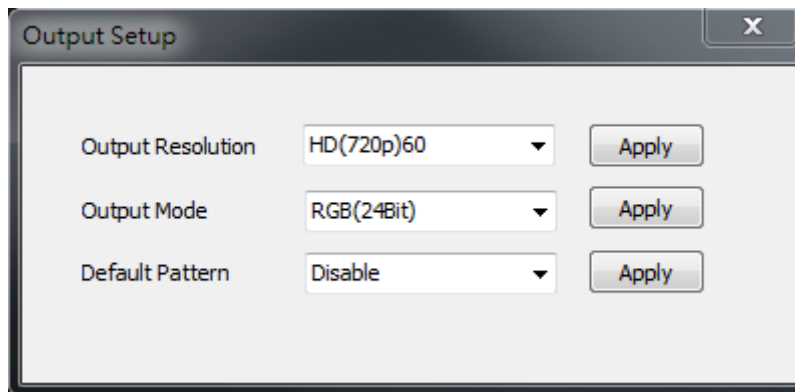

4. Image Button

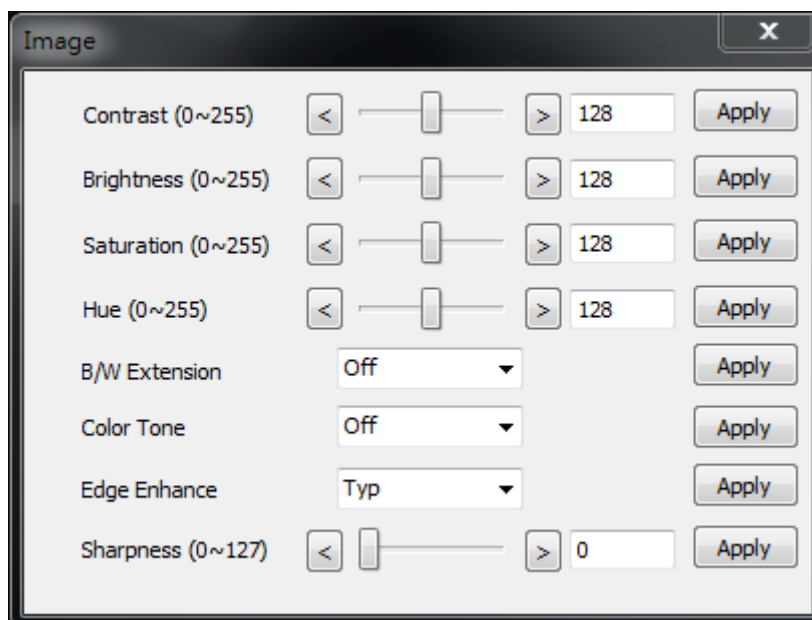

5. Adjustment Button

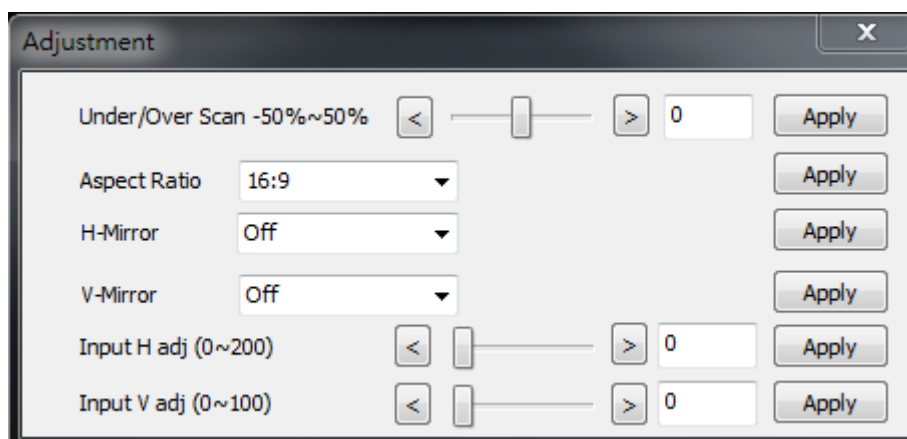

6. System Button

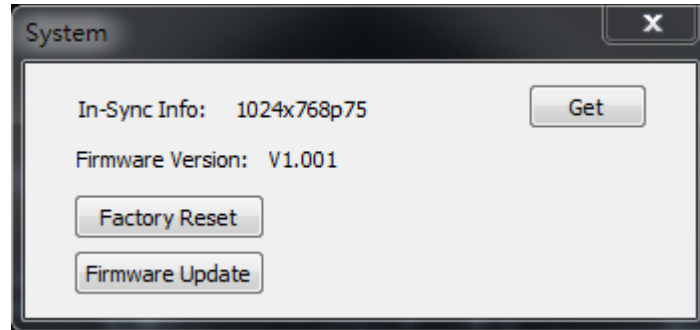

- 1) In-Sync Info:
To view the current input resolution
- 2) Factory Reset Button
- 3) Firmware Update Button

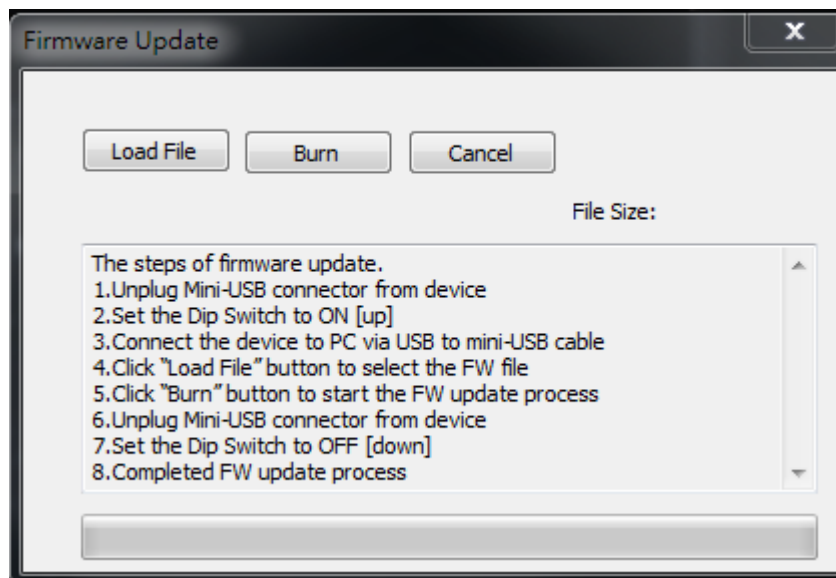

The steps of firmware update:

- a) Unplug Mini-USB connector from device
- b) Set the Dip Switch to **ON [↑]**
- c) Connect the device to PC via USB to mini-USB cable
- d) Click the FW Update button on software
- e) Click "Load File" button to select the FW file
- f) Click "Burn" button to start the FW update process
- g) Unplug Mini-USB connector from device
- h) Set the Dip Switch to **OFF [↓]**
- i) Completed FW update process

7. I/O Port and Resolution Info

To display the information about the I/O Port and the applied Resolution

8. Refresh Button

To refresh the status of the converter

9. Output Quick Selection Button

Common functions for quick setting

LIMITED WARRANTY

The SELLER warrants the **CV-905S VGA & Audio to HDMI Scaler Converter** to be free from defects in the material and workmanship for 1 year from the date of purchase from the SELLER or an authorized dealer. Should this product fail to be in good working order within 1 year warranty period, The SELLER, at its option, repair or replace the unit, provided that the unit has not been subjected to accident, disaster, abuse or any unauthorized modifications including static discharge and power surges.

Unit that fails under conditions other than those covered will be repaired at the current price of parts and labor in effect at the time of repair. Such repairs are warranted for 90 days from the day of reshipment to the BUYER. If the unit is delivered by mail, customers agree to insure the unit or assume the risk of loss or damage in transit. Under no circumstances will a unit be accepted without a return authorization number.

The warranty is in lieu of all other warranties expressed or implied, including without limitations, any other implied warranty or fitness or merchantability for any particular purpose, all of which are expressly disclaimed.

Proof of sale may be required in order to claim warranty. Customers outside Taiwan are responsible for shipping charges to and from the SELLER. Cables are limited to a 30 day warranty and cable must be free from any markings, scratches, and neatly coiled.

The content of this manual has been carefully checked and is believed to be accurate. However, The SELLER assumes no responsibility for any inaccuracies that may be contained in this manual. The SELLER will NOT be liable for direct, indirect, incidental, special, or consequential damages resulting from any defect or omission in this manual, even if advised of the possibility of such damages. **Also, the technical information contained herein regarding the CV-905S features and specifications is subject to change without further notice.**

