



*The absolute opposite of ordinary*

# G406 Quick User Guide

***G406 4K/60 video wall controller  
with matrix SW function***



Technical support:

E-mail: [sales@vnstw.com](mailto:sales@vnstw.com)

Tel: +886-2-2792-2819 Cell: +886-935-678-033

Skype: vnsw-inc

Version: 1.4

Website: [www.vnstw.com](http://www.vnstw.com)

<b>DCi/UHD</b> 4k/60/4:4:4	<b>HDMI 2.0</b> DisplayPort 1.2	<b>HDCP</b> 2.2/1.4	<b>HDR</b> Ready	<b>10-bit</b> High-end scaler	<b>Cadence</b> Film 3:2 / 2:2	<b>3D Motion</b> De-interlace	<b>Deep Color</b> xVCC/12-bit	<b>Matrix SW</b> Free source selection
<b>Mosaic</b> Irregular wall	<b>Multi-Unit</b> Cacade	<b>Multi-view</b> Discrete display	<b>Flexible</b> Aspect Ratio Bezel Correction	<b>Rotation</b> Landscape Portrait	<b>Loop Out</b> Daisy chain	<b>Control</b> IR/USB/RS232 /Ethernet	<b>Projector</b> Output overlap	<b>RoHS</b> CE FCC

## Table of Contents

Disclaimer/Copyright statement.....	1
Warranty/RMA and FCC/CE statement.....	2
Introduction.....	3
Feature.....	3
Quick User Guide.....	4
Content in the packing box.....	4
How to use IR Remote Controller.....	4
System Setup procedures.....	5
1 Step 1 – Connecting the Inputs.....	5
2 Step 2 – Connecting the Outputs.....	5
3 Step 3 – HDMI Loop Out for Multiple Units Connection.....	6
4 Step 4 – System Connection and Power On.....	7
5 Step 5 – Input Source / Output Resolution Selection & LED Lights.....	8
6 Step 6 – Front Panel Keypad Operation.....	8
7 Step 7 – Conventional Video Wall Settings.....	9
7.1 [Zoom] – Split Source Image.....	9
7.2 [Pan] – Assign Image Position.....	9
7.3 [Overlap] – Bezel Compensation and Position Alignment.....	10
8 Step 8 - Irregular / Asymmetric video wall setting.....	10
8.1 Introduction.....	10
8.2 Wind-Mill Asymmetric Video Wall Setup Procedures.....	11
8.3 Square Asymmetric Video Wall Setup Procedures.....	14
9 Flexible Aspect Ratio Adjustment.....	16
10 Step 9 - Save System Settings through OSD Menu.....	17
11 Step 10 - Load Profile Index through Front Panel hotkeys.....	17
12 Step 11 - Load Profile Index through Remote Controller.....	17
13 Important Notice for Video Wall Settings.....	18
14 Easy Settings in Multiple Unit Application.....	18
14.1 Setup by Remote Controller.....	18
14.2 Setup by Ethernet.....	18
14.2.1 WebGui.....	19
14.2.2 UHDWall Manager PC tool.....	20
15 System Structure and Control.....	21
15.1 System Structure: Group A & Group B.....	21
15.2 OSD Command Execution in Group A & Group B.....	21
15.3 EDID Setting.....	22
15.4 HDMI vs. DVI Output Signal.....	22
15.5 System Standby and Automatically Turn Off output Signal.....	22
15.6 RS232 Setting.....	22

---

<b>15.7 Ethernet Setting (Please see more details in Section 14.2)</b> .....	<b>23</b>
<b>15.8 Change Background Color</b> .....	<b>23</b>
<b>16 Limitations in Image Flip and Rotation</b> .....	<b>23</b>
<b>17 Limitation in Audio Output</b> .....	<b>23</b>
<b>18 Trouble Shooting</b> .....	<b>24</b>
<b>19 Technical Support</b> .....	<b>24</b>
<b>20 Safety Precaution and Maintenance</b> .....	<b>24</b>
<b>Specifications</b> .....	<b>26</b>
<b>Revision history</b> .....	<b>27</b>

**Disclaimer/Copyright Statement**

Copyright 2018, VNS Inc. All Right Reserved

This information contained in this document is protected by copyright. All rights are reserved by VNS Inc. VNS Inc. reserves the right to modify this document without any obligation to notify any person or entity of such revision. Copying, duplicating, selling, or otherwise distributing any part of this document without signing a non-disclosure agreement with an authorized representative of VNS Inc. is prohibited. VNS Inc. makes no warranty for the use of its products and bears no responsibility for any error of omission that may appear in this document. Product names mentioned herein are used for identification purposes only and may be trademarks of their respective companies.

**Limited Warranty and RMA statement**

This device is designed and tested to the highest standards and backed by two years' parts and labor warranty. Warranties are effective upon the first delivery date to the end customer and are non-transferable. Warranty related repairs include parts and labor, but do not include repair of faults resulting from user negligence, special modifications, abuse (mechanical damage), shipping damage, and/or other unusual damages. The customer shall pay shipping charges when the unit is returned for repair. Manufacturer will pay shipping charges for return shipments to customers.

Manufacturer does not assume responsibility for consequential damages, expenses or loss of revenue, inconvenience or interruption in operation experienced by the customer. Warranty service shall not automatically extend the warranty period.

User can pay extension fee to extend the warranty period. Please contact us for more details. In the event that a product needs to be returned for repair, inform manufacturer and ask for a Return Material Authorization number.

**FCC/CE statement**

This equipment has been tested and found to comply with the limits for a Class A digital device, pursuant to part 15 of the FCC Rules. These limits are designed to provide reasonable protection against harmful interference when the equipment is operated in a residential / commercial environment. This equipment generates, uses, and can radiate radio frequency energy and, if not installed and used in accordance with the instruction manual, may cause harmful interference to radio communications. Operation of this equipment in a residential area is likely to cause harmful interference in which case the user will be required to correct the interference at his own expense.

## Introduction

GeoBox G406 is the state-of-the-art DCi/UHD 60fps four screens video wall controller to allow great freedom in creating any scale video wall with multiple contents and different LCD arrays. It incorporates two HDMI 2.0, two DisplayPort 1.2 inputs and two HDMI 2.0 loop-through ports with HDCP 2.2/1.4 as well as four synchronized Full HD outputs. Each output has independent image rotation/flip, scaling, cropping and color adjustment.

G406 is designed with matrix switcher function to display 1, 2, 3 or 4 independent contents on four LCD video wall. Two HDMI 2.0 loop-through ports are designed for multiple unit cascade and allows user to select different contents for entire video wall.

It is pure hardware, standalone system with easy-of-use. All operations can be implemented through front panel keypads, IR remote controller, USB, RS232 or Ethernet. No additional PC, Zero Client, appropriate device or software tool is required, simple and more reliable. It can be connected with all kinds of signal sources such as PS4 XBOX, Blue Ray player, media player and interactive system with low latency and quick response without the issues in system synchronization, virus and hacker.

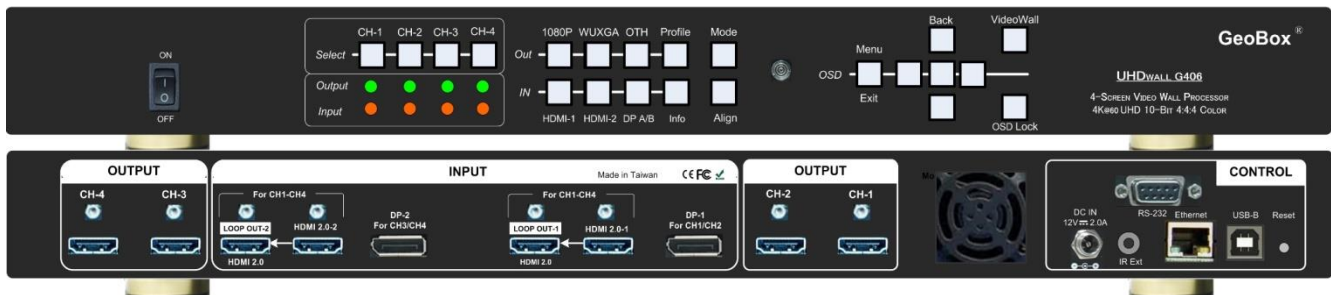

## Features

- ✧ 4x outputs in one box with multi-unit cascade function.
- ✧ 4x UHD/DCi 60fps inputs, 4x WUXGA/1080p outputs.
- ✧ Support up to 4096x2400@60Hz input through HDMI 2.0 & DisplayPort 1.2.
- ✧ HDCP compliant in all inputs and outputs (HDMI: HDCP 1.4/2.2, DP: HDCP 1.3)
- ✧ Matrix switch function to allow multiple window display, 1/2/3/4 contents on 4x LCD
- ✧ Dual Loop-through ports for multiple units cascade in any scale display with selectable inputs.
- ✧ Pixel base position alignment up to +\_ 900 pixels in H&V for flexible image capture, cropping, position alignment, bezel compensation & irregular video wall.
- ✧ Set overlap output up to 900 pixels for projector edge blending application.
- ✧ Independent Image color adjustment, cropping, scaling and bezel correction in each channel.
- ✧ Independent image rotation and flip/mirror in each channel for variable landscape, portrait and irregular video wall display.
- ✧ Selectable output resolution and programmable EDID for optimized input to provide superior video quality.
- ✧ Frame-Lock function to get perfect synchronization among output channels.
- ✧ Support HDR 10 high dynamic Range color.
- ✧ G406 can sever as one Quad channel processors or two independent dual channel processors to support up to 8k width input signal from one G406.
- ✧ Easy setup via IR, front panel Keypad, USB, RS232 & Ethernet. No PC is required.
- ✧ Flexible RS232 + Ethernet simultaneous system control.
- ✧ Support super high resolution content (more than 8k/4k) through multiple 4k inputs.
- ✧ Ready for 24/7 working environment.

# Quick User Guide

## Content in the box

- The G406 Quad Channel Video Wall Controller
- 1x RC-700 IR Remote Controller with battery
- 1x IR Extending Receiver with 1.8m cable
- 1x AC Main Power Cable
- 1x DC 12V Power Supply Unit
- Mounting Rack with screw (Option)
- Please download User Guide, PC Tool, Firmware update Tool at [www.vnstw.com](http://www.vnstw.com).

## How to Use IR Remote Controller

- IR remote controller has all the functions same as front panel for the operation of G406.
- IR receiver is on Front Panel. One 3.5ø mm audio connector for IR extender is located at Back Panel of G406. 1.8m IR extension cable is equipped in the packing. User can add audio cable to extend the distance up to more than 20 meters.

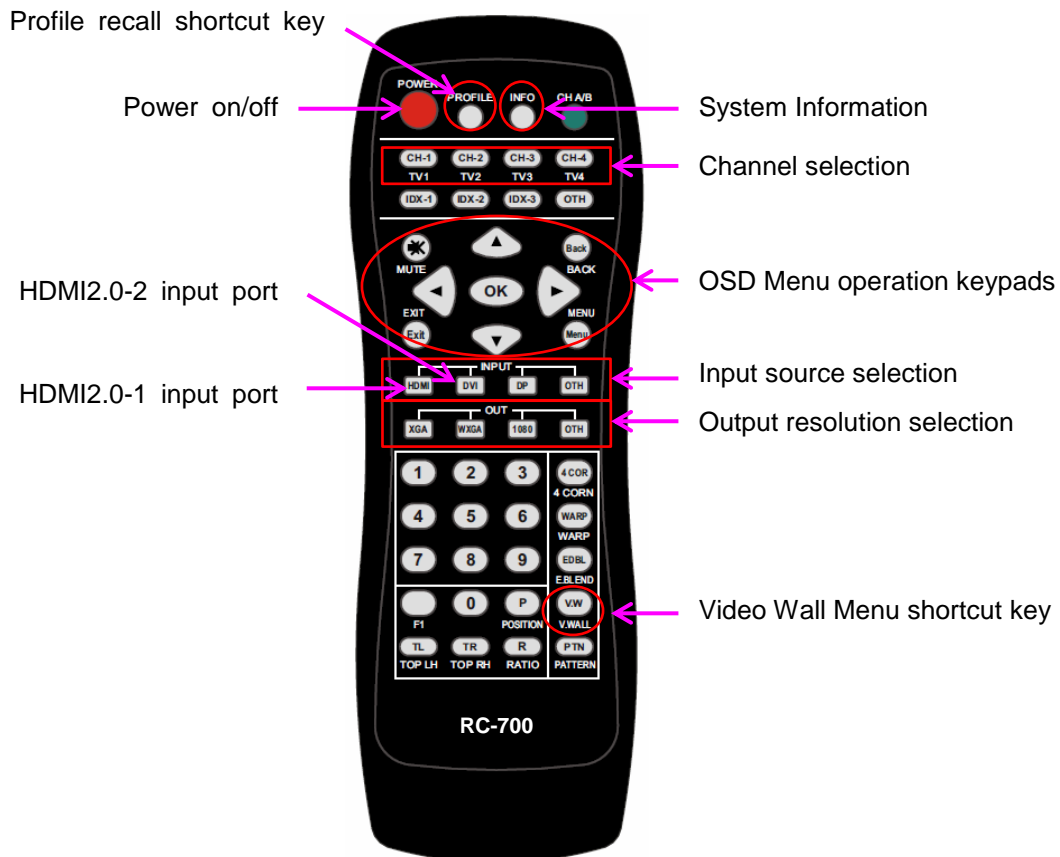

## System Setup Procedures

### 1 Step 1 – Connecting The Inputs

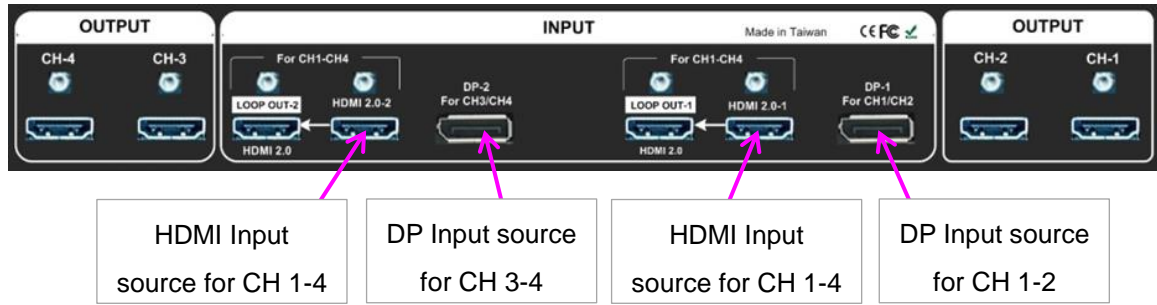

- 1.1 HDMI2.0-1 or HDMI2.0-2 input source can be displayed across entire video wall (all-in-one).
- 1.2 Each HDMI input source can be displayed in either CH 1/2 or CH 3/4 output freely to show two discrete contents on the video wall. It is one kind of matrix switch function.
- 1.3 CH 1/2 output is set as Group A and CH 3/4 is Group B. Each Group can only select one HDMI input source. While CH-1 selects HDMI2.0-1 as input source, if user selects HDMI2.0-2 for CH-2, then CH-1 input source will be also switched to HDMI2.0-2 at the same time. Group B (CH 3/4) will have the same limitation.
- 1.4 DP-1 input source can only be displayed in CH-1 or CH-2 output port. DP-2 input source can only be displayed in CH-3 or CH-4.
- 1.5 When DP input source is selected for one output port, the other output port in the same Group still can select the source from the same DP input or any HDMI input source.
- 1.6 User can configure the input signal sources to display 1, 2, 3 or 4 contents across 2x2 video wall.

### 2 Step 2 – Connecting The Outputs

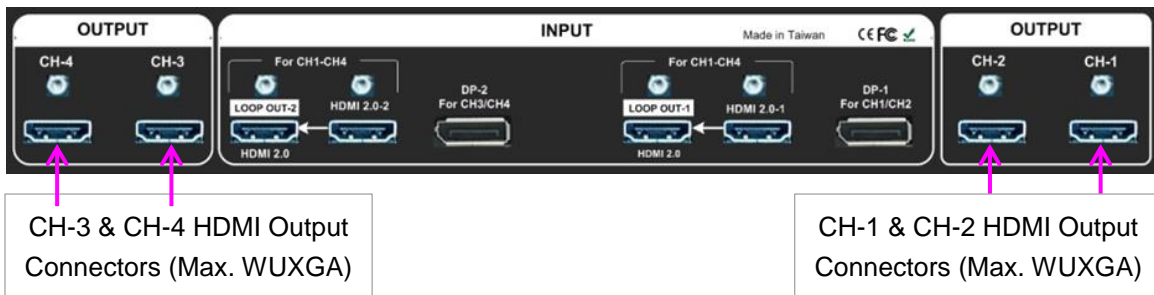

- 2.1 If user wants to display single content across entire video wall, user can connect any output to any monitor without limitation. User can assign the final image location through Video Wall menu settings.
- 1.1 If user wants to display DisplayPort input source in specific location or to display 2/3/4 different contents in the video wall, user needs to arrange the output connection in Group A & Group B.
- 1.2 Pay attention that DP1 can only be displayed in CH1/2. DP2 can only be displayed in CH3/4.

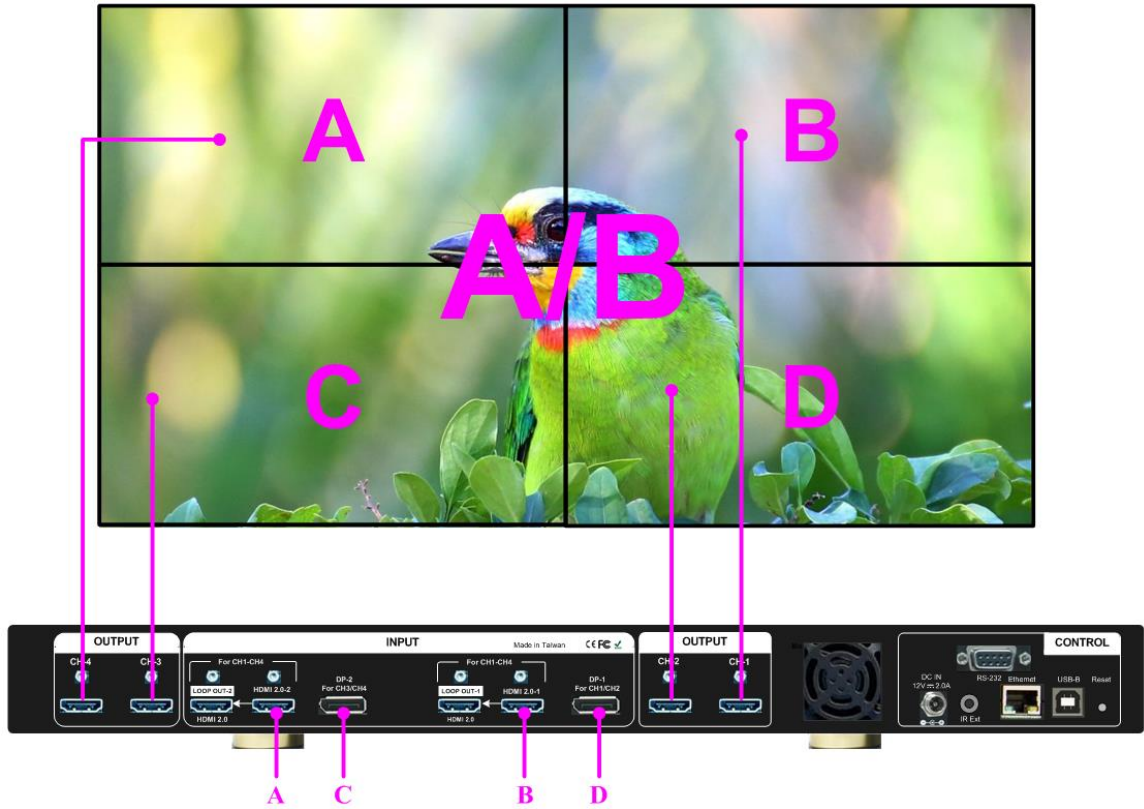

For discrete content display, A & B, A & C or B & D locations can be swapped.

### 3 Step 3 – HDMI Loop Out for Multiple Unit Connection

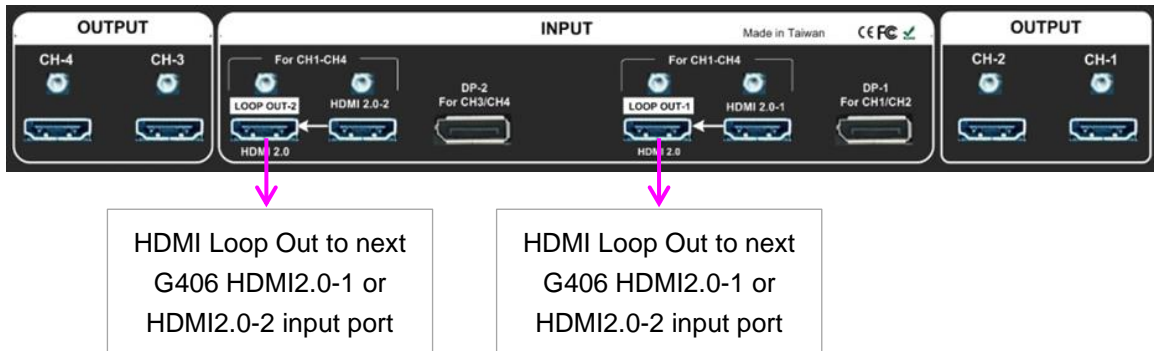

- 3.1 Loop Out-1 provides the same unprocessed source signal from HDMI2.0-1 input port. Loop Out-2 provides the same unprocessed source signal from HDMI2.0-2 input port.
- 3.2 User can connect any Loop Out signal to any HDMI input port in the next G-406. No specific HDMI input port is assigned.
- 3.3 User can connect up to more than 10 units of G406 through daisy chain connection. The daisy chain connection number is related to the quality of HDMI connection cables—good cable can do more units in daisy chain connection.
- 3.4 When user connects two Loop Out ports through daisy chain connection, user can select any looping signal source to display across entire video wall. User can also display multi-windows through adding signal sources from DisplayPort input in each G406. Different settings can be stored in Profile Index and recall through front panel, IR remote controller, RS232 or Ethernet control.

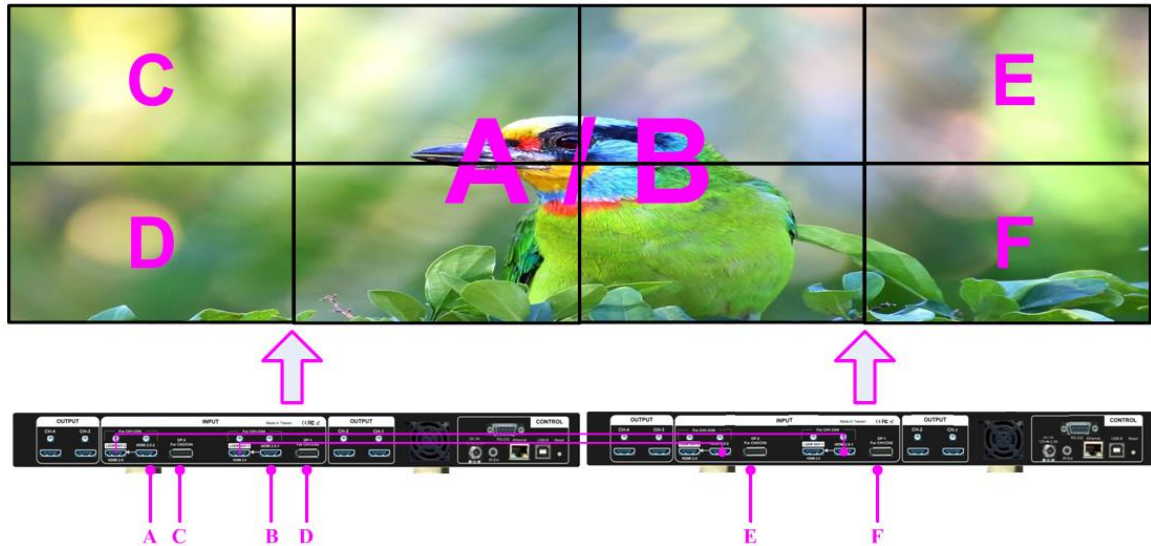

*A & B can be displayed at any monitor. Each DP input source can be displayed at two monitors.*

#### 4 Step 4 – System Connection and Power On

- 4.1 Poor quality HDMI cable and signal source will affect the connection distance and may cause signal noise.
- 4.2 To ensure all cables are connected correctly, it is recommended to use locking cables.



- 4.3 Complete video wall system should be connected to one power Distribution Box with proper grounding. Power on the system after finishing all connections to avoid system damage by floating voltage among devices.
- 4.4 When power is switched on G406, the booting time is about 19 seconds and the Input & Output LEDs on front panel will stay “Lighted” permanently for the channel with correct input source and output monitor connections.



## 5 Step 5 - Input Source / Output Resolution Selection & LED Indicators

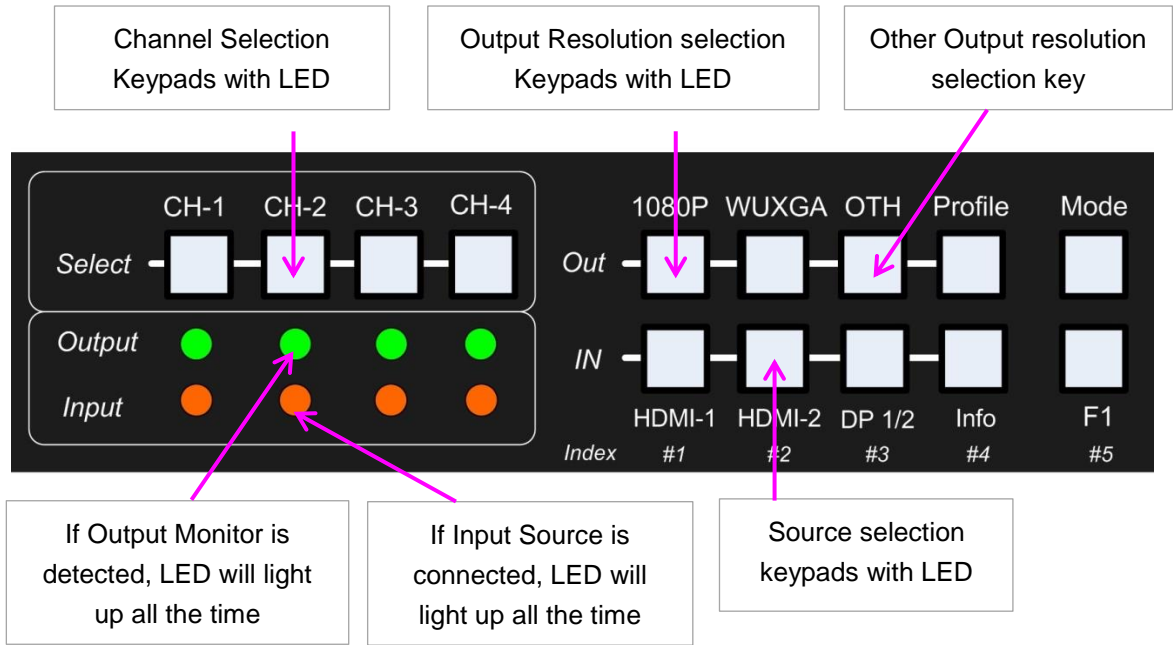

- The output resolution selection will apply to both output channels in the same display group (CH-1/CH-2 or CH-3/CH-4). Group A and Group B can select different output resolutions.
- Green LED will light up on the keys to show user selection status.
- Output resolution list: 1920x1200, 1920x1080, 1280x720, 1360x768, 1280x800, 1024x768
- All output resolution is 60Hz and progressive.
- Input resolution is determined by signal source. G406 can support non-VESA standard input timing.
- When press [OTH] key to select output resolution, it will take few seconds to finish the selection. After finishing mode change, it will show the resolution result on the screen.
- User can click [Info] key to get system information and see input / output signal resolution.

## 6 Step 6 - Front Panel Keypad Operation

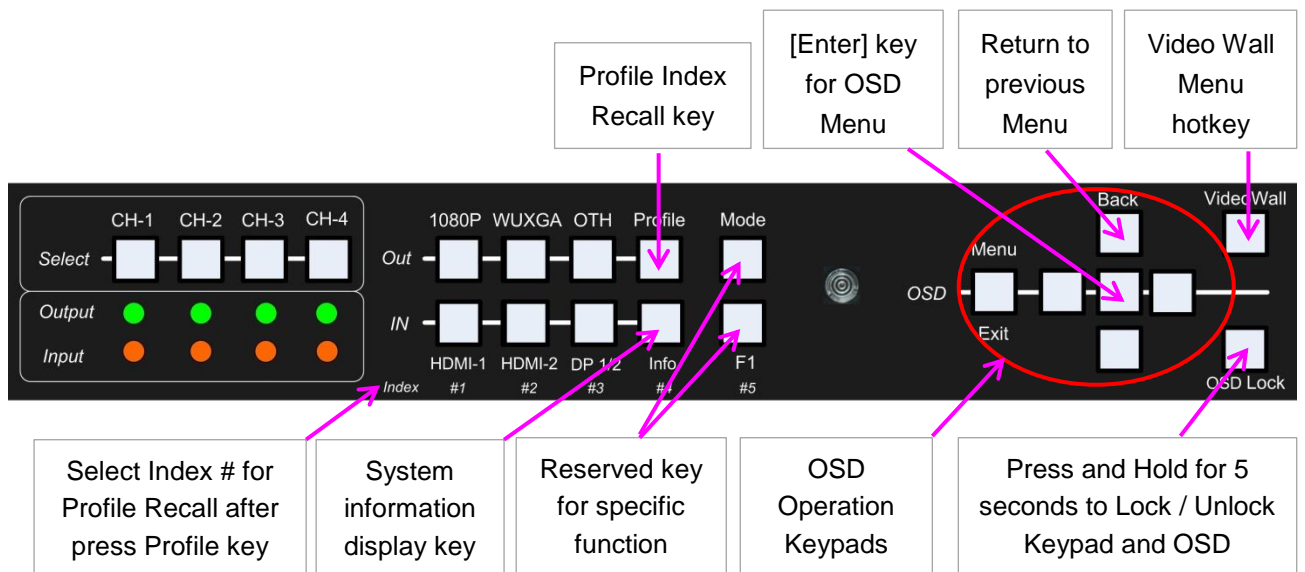

OSD Lock function will apply to all channels at the same time. When OSD Lock is enabled, Channel Key LED will be flashing. To press OSD Lock key again for 5 seconds, it will unlock OSD menu.

## Step 7 – Conventional Video Wall Settings

Press [Video Wall] hotkey on Front Panel or Remote Controller to activate [Video Wall] menu. WebGui and UHDWall Manager PC tool are available for Ethernet configuration.

### 7.1 [Zoom]

Use [Zoom] to split the display in horizontal and vertical directions. GeoBox will cut the image into different sections. Maximum split image is 15 in both horizontal and vertical directions.

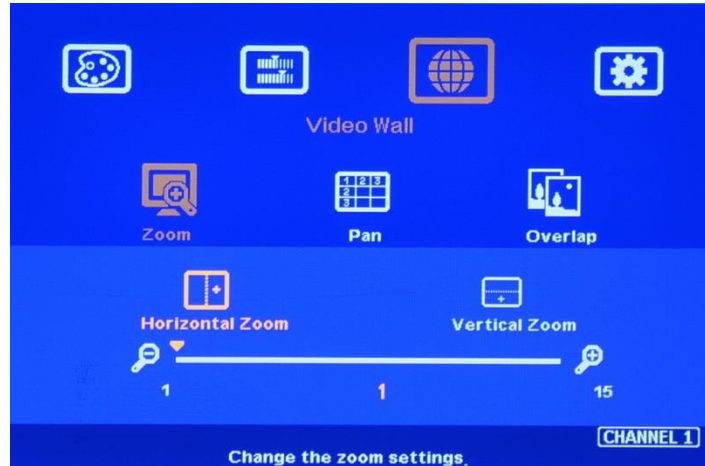

*For 3x1 displays*

*Horizontal Zoom= 3, Vertical Zoom = 1*

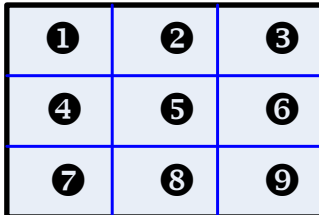

*For 3x3 displays*

*Horizontal Zoom = 3, Vertical Zoom =3*

### 7.2 [Pan]

[Pan] will assign the location of each split image in the display in both horizontal and vertical directions. Horizontal direction is counted from Left to Right and Vertical direction is counted from Top to Bottom.

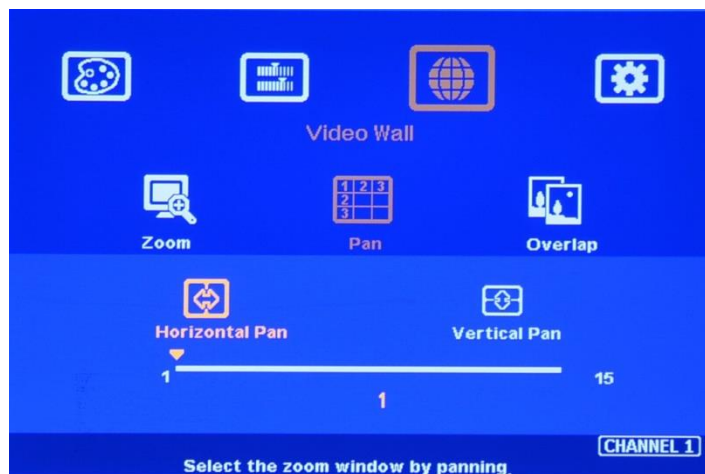

In the case of 3x3 display, Pan settings are as below:

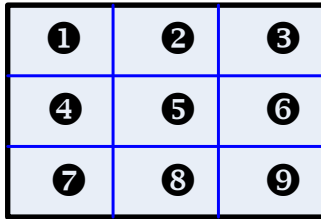

For No. ③ monitor:

Horizontal Pan = 3

Vertical Pan = 1

For No. ⑥ monitor:

Horizontal Pan = 3

Vertical Pan = 2

### 7.3 [Overlap] – Bezel Compensation and Position Alignment

[Overlap] adjustment changes the cropping area of the image so that image position in each monitor will be shifted. It can compensate Bezel Size of the monitor and correct misalignment in monitor installation. If overlap value is decreased, each monitor will crop less image area and cause [zoom in] (enlarged) effect. If overlap value is increased, each monitor will crop more image area and cause [zoom out] (shrunk) effect. User can also use this function to shift the whole image location for irregular video wall and set overlap area for projector edge blending application.

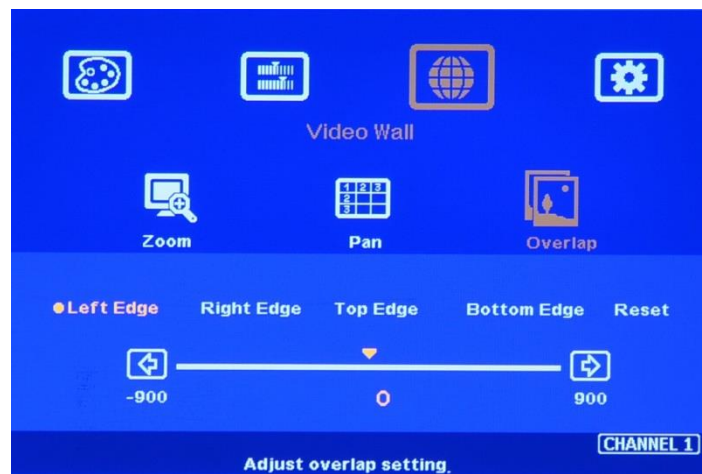

- Maximum [Overlap] adjustment value is 900 pixels in all directions.
- User can see the image and select Edge to adjust [Overlap] value for Bezel compensation.
- User can also calculate the pixels number for bezel compensation based on the video wall dimension and bezel size. If the video wall active display area is 360cm in width and the input source is 3840, then the pixel number for each centimeter is  $3840/360=10.67$  pixel/cm. If the bezel size is 12mm in one edge, then user can decrease Overlap value  $10.67*1.2=12.8$  (13) pixels to do bezel compensation for that edge (to enlarge the image 13 pixels at that edge).
- User can use [Overlap] function to stretch the image outside video wall (some image will be missing) or draw image inside video wall with Black blanking area at the edge. This function can adjust the aspect ratio of the content to match required aspect ratio of the video wall. Please see more details in [Flexible Aspect Ratio Adjustment] section.

## 8 Irregular / Asymmetric Video Wall Settings

### 8.1 Introduction

- Asymmetric video wall can be created by rotating monitor installation direction or position. User can crop different area image for each monitor, rotate image direction and adjust image position through G406 to achieve it.

*Note: Image flip and rotation are only available when input resolution is under 4k/2k @30Hz.*

- User can use monitors with different dimensions, bezel size and resolution as display devices. No data base for monitor is required and it allows user to have installation position deviation. All of these factors can be corrected by GeoBox video wall settings.
- G406 can only rotate the image at 90/180/270 degrees. The monitors need to be installed at landscape or portrait position. If users want to install monitor at other rotation angle, G-403 model should be used.

**8.2 Wind-Mill Asymmetric Video Wall Setup Procedures**

➤ **System connection (example)**

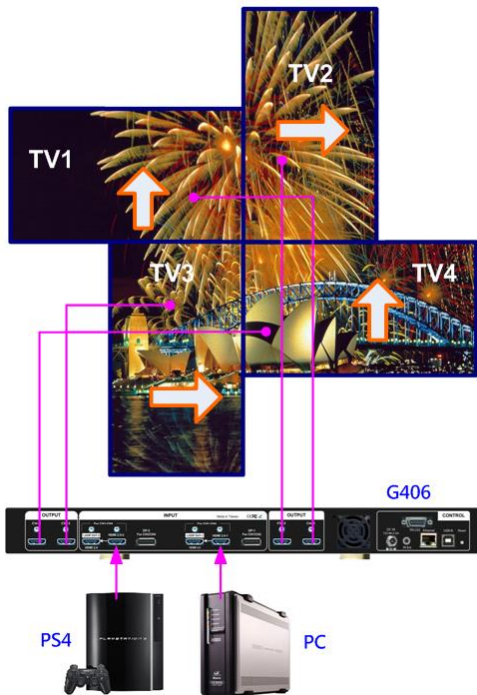

- Monitor can be with different bezel size, screen dimensions, and resolution.
- All monitors can be installed at 90 / 180 / 270 degree display direction.
- Each monitor can be connected with any output port. (In this example, CH1→ TV1, CH2→ TV2, CH3→ TV3, CH4→ TV4)
- User can select any signal source (i.e. PS4 or PC) to display on video wall.
- Able to display both signals from PS4 & PC at the same time.
- Below setup example is based on the drawing as showed left.

➤ **Apply test pattern from signal source**

Below test pattern should be applied as signal source for easy setup. Please download from below website: <http://www.vnstw.com/otherfile/14/file249-1-20180319194450-84.png>

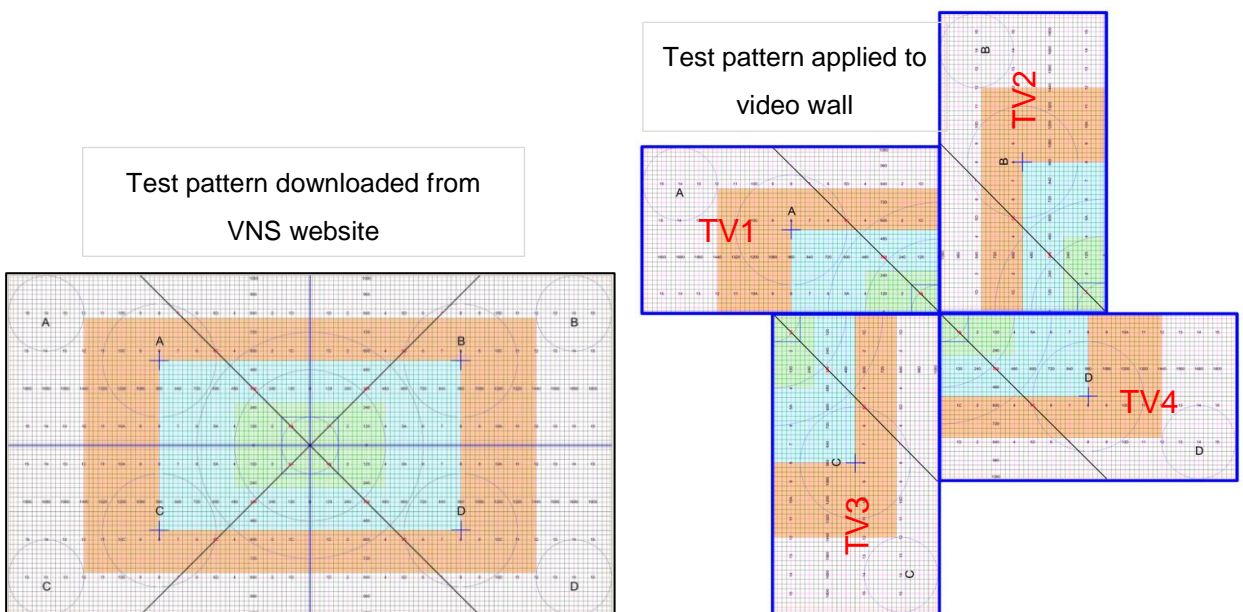

- **Split the content by [Zoom]**
  - Set [Horizontal Zoom]=2, [Vertical Zoom]=2 in all channels.
  - If TV2 & TV3 dimension is small, user can set TV2 & TV3 [Horizontal Zoom]=4 and [Horizontal Pan]: TV2=3, TV3=2, so that user can reduce the image position adjustment range.
- **Assign image location by [Pan]**
  - Set [Horizontal Pan]: TV1=1, TV2=2, TV3=1, TV4=2
  - Set [Vertical Pan]: TV1=1, TV2=1, TV3=2, TV4=2
- **Image rotation**

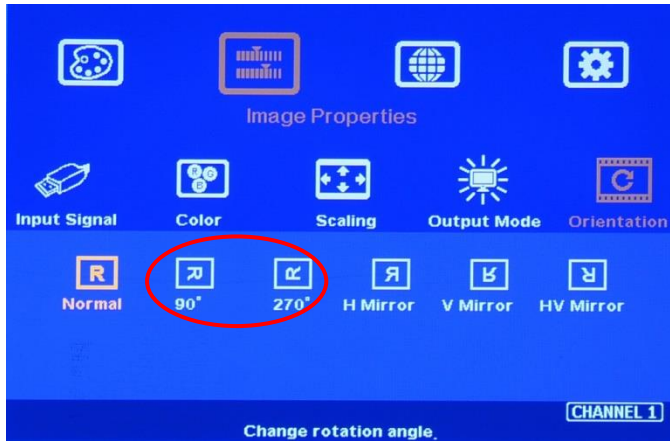

Use [Orientation] menu to rotate images in TV2 and TV3 to display the same image direction.

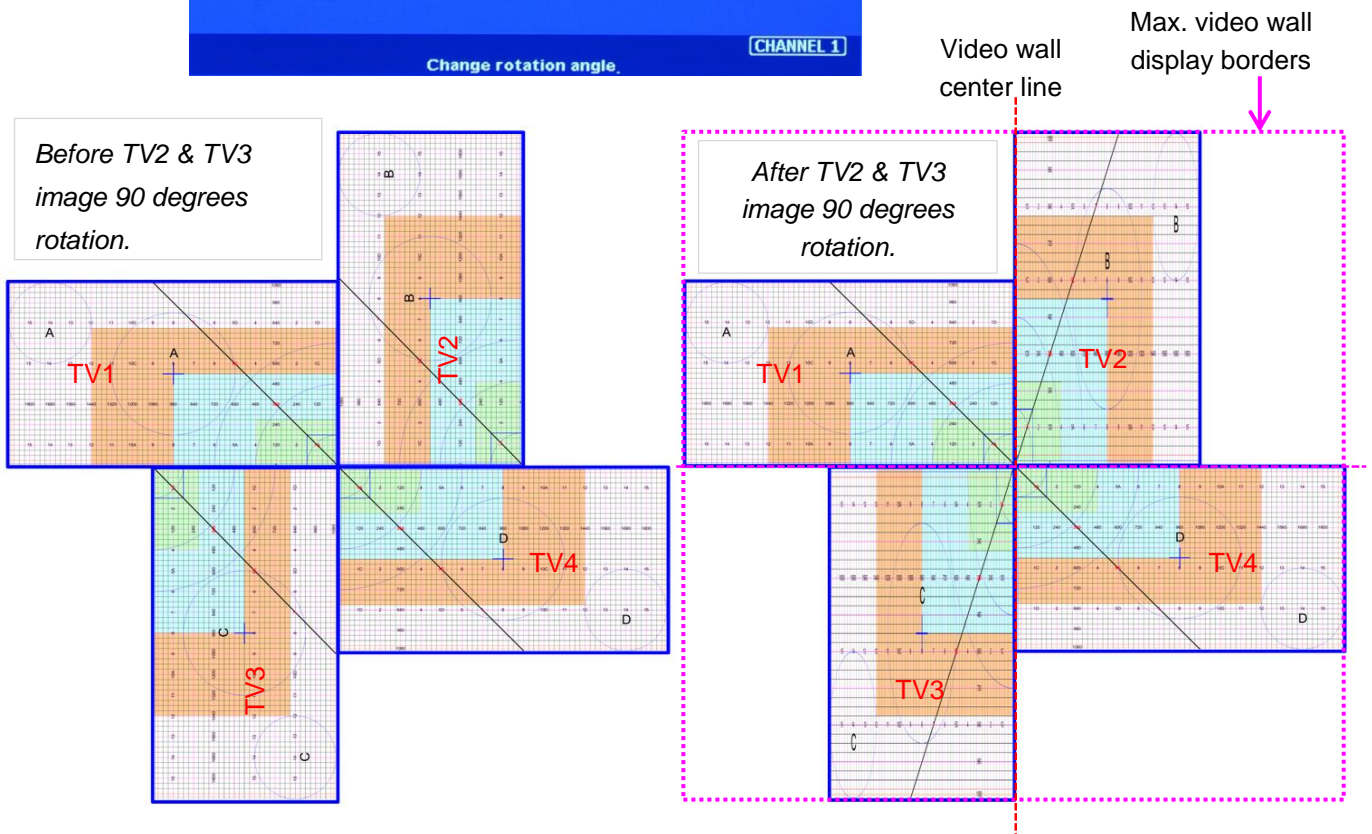

- **Set standard position as reference in horizontal and vertical directions**
  - User should determine Horizontal & Vertical image sizes and reference position so that all monitors have criteria for image position adjustment.
  - Usually, image display borders are the maximum active display borders in the video wall.
  - In the above example, the horizontal borders are decided by TV1 & TV4. Vertical borders are decided by TV2 & TV3.
  - User can decide video wall display center through test pattern. It can be asymmetric.

➤ Adjust image position by [Overlap] menu to finish video wall settings

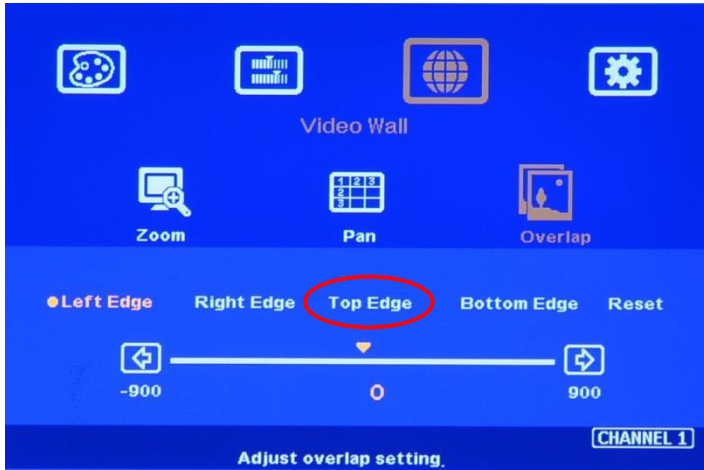

- 1 [Overlap] is to change image capture range.
- 2 Decrease value in Top Edge of TV1 will stretch top edge of TV1 to match image position of TV2.
- 3 For TV2 adjustment, user needs to adjust Overlap value based on the actual image direction but not based on OSD direction. In this example, user needs to stretch Right Edge.

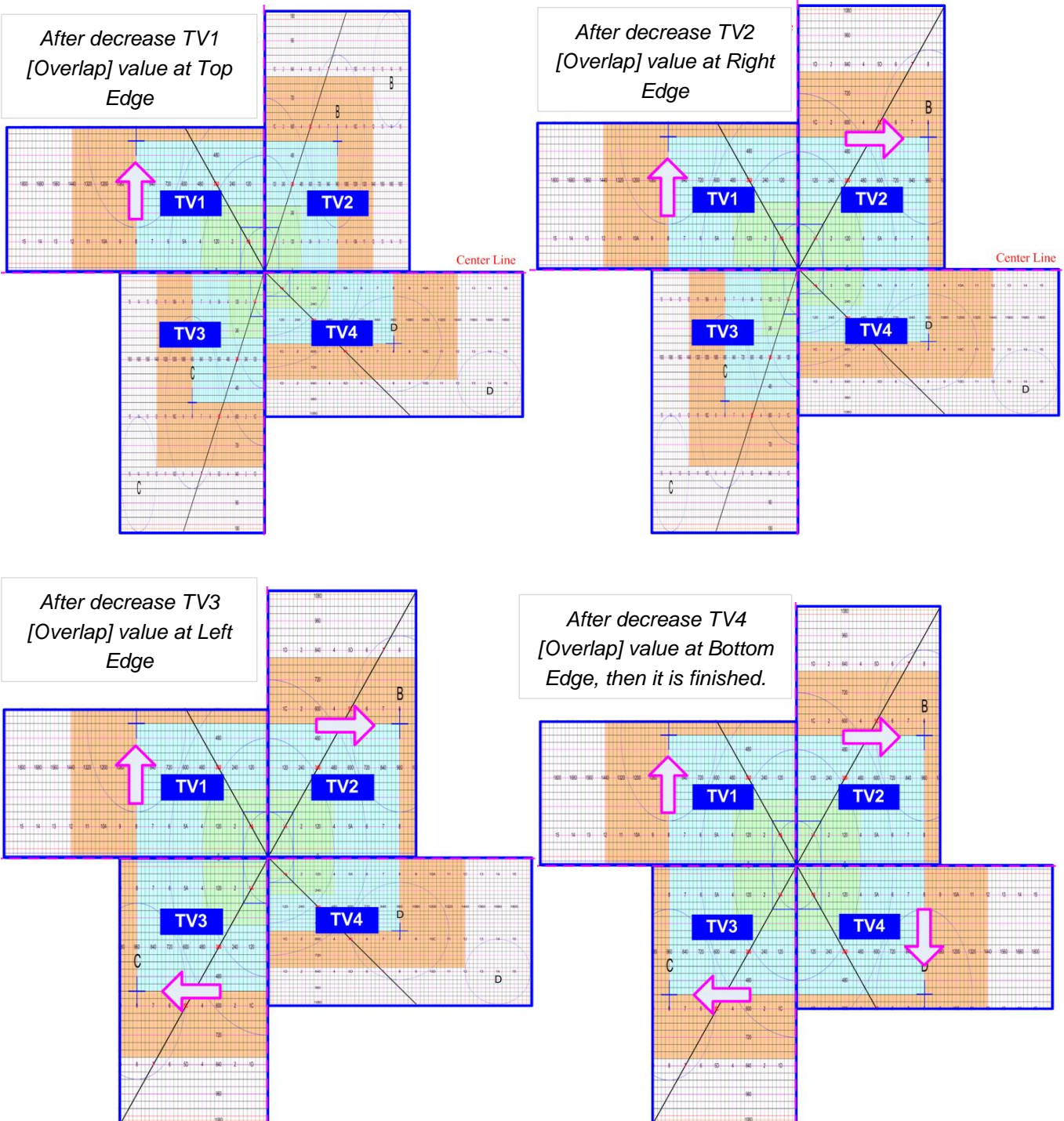

**8.3 Square Asymmetric Video Wall Setup Procedures**

- Step 1: Video Wall settings for all channels

[Zoom]: H=2, V=2

[Pan]: TV1: H=1, V=1, TV2: H=2, V=1, TV3: H=1, V=2, TV4: H=2, V=2

- Step 2: Apply Test Pattern and Rotate TV1 & TV4 images at 90 degrees

*Original Image after applied test pattern*

*Image after image rotation in TV1 & TV4*

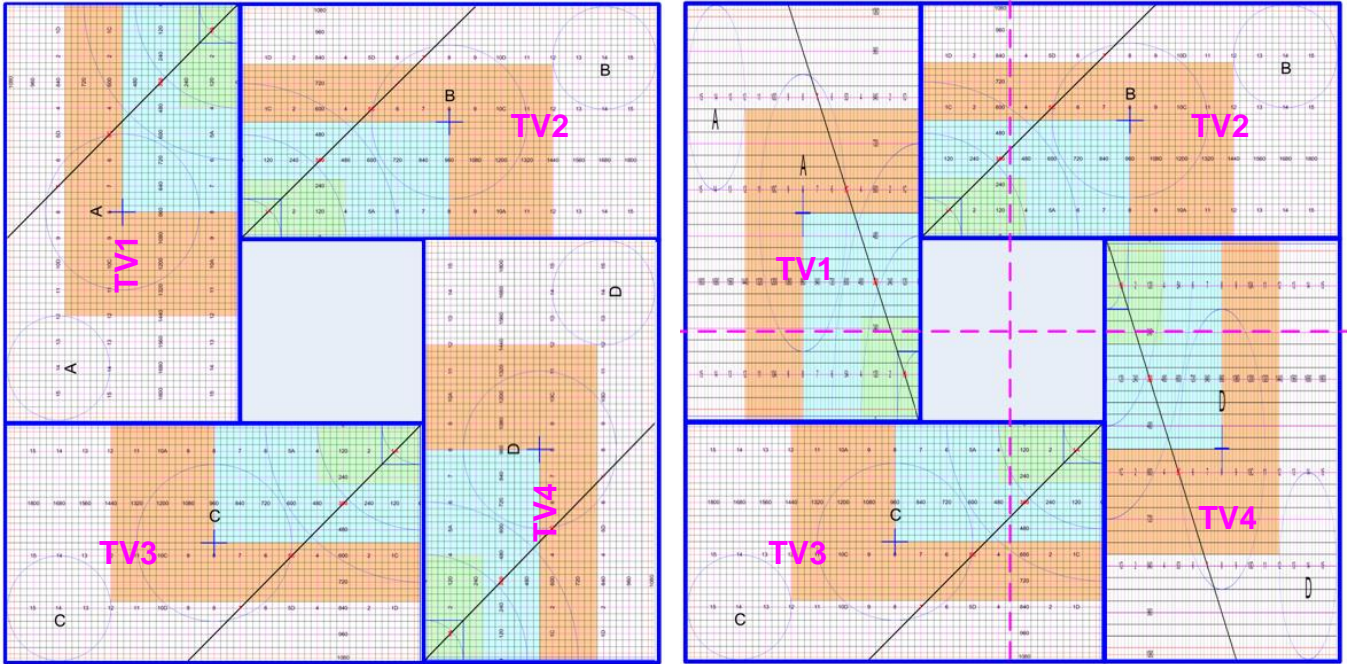

- Step 3: Determined image center, marked with paper tape.
- Step 4: Set standard Position Reference in horizontal and vertical directions

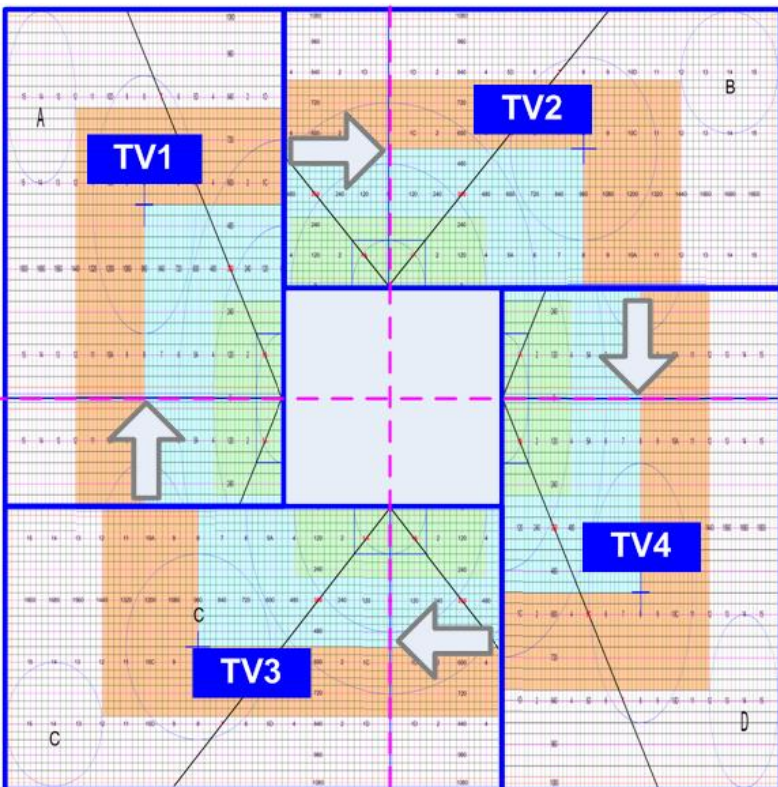

- ✓ Horizontal Position Reference is determined by TV2 & TV3 and Vertical Position Reference is determined by TV1 & TV4.
- ✓ Once user can line up the image center to Video wall center H&V lines, it can serve as Position Reference lines.
- ✓ Left figure shows the result after setting Horizontal and Vertical Position Reference (Move TV1 center line up, TV2 center line to Right, TV3 center line to Left and TV4 center line down—please see the arrow direction)

TV1: increase [Overlap] value in Bottom Edge to move Horizontal center line up to video wall center  
 TV2: increase [Overlap] value in Left Edge to move Vertical center line right to video wall center.  
 TV3: increase [Overlap] value in Right Edge to move Vertical center line left to video wall center.  
 TV4: increase [Overlap] value in Top Edge to move Horizontal center line down to video wall center.

- Step 5: Individual monitor position adjustment based on Horizontal and Vertical Position Reference resulting from the previous step 4.

TV1: increase [Overlap] value in Left Edge and decrease [Overlap] value in Right Edge to align Vertical lines to match TV3

TV2: increase [Overlap] value in Top Edge and decrease [Overlap] value in Bottom Edge to align Horizontal lines to match TV1

TV3: increase [Overlap] value in Bottom Edge and decrease [Overlap] value in Top Edge to align Horizontal lines to match TV4

TV4: increase [Overlap] value in Right Edge and decrease [Overlap] value in Left Edge to align Vertical lines to match TV2

- Step 6: After final image position, all horizontal and vertical pattern can be matched together. The setup procedure is finished.

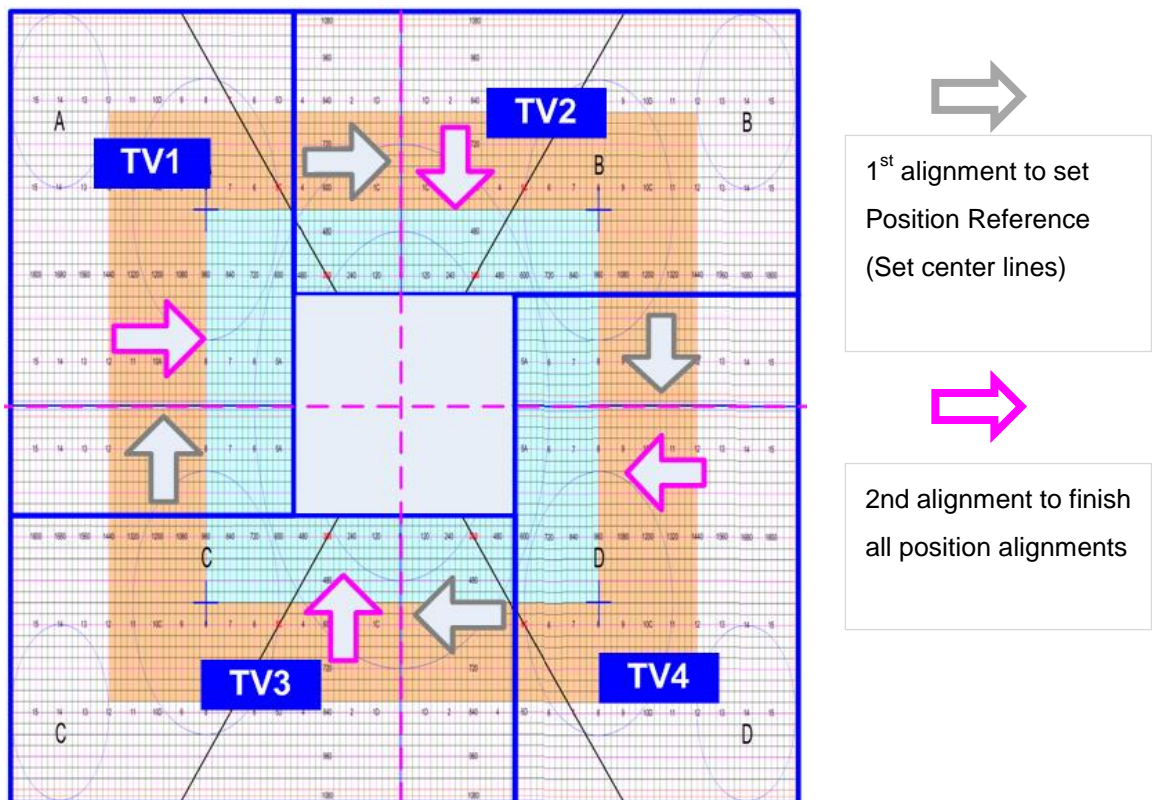

- Aspect Ratio and image distortion
  - If the source content aspect ratio is not 1:1 in this Video Wall setting, the final image will have some distortion.
  - User can adjust source resolution and content aspect ratio to fix this issue
    - Set display EDID with 2160\*2160 with same as the aspect ratio of Video Wall.
    - Use PC as signal source with 2160\*2160 output resolution and apply content with 1:1 aspect ratio. Customized output resolution setting in PC may be required.



- If source resolution and content doesn't match the above conditions, user can adjust the display aspect ratio in video wall settings to reduce image distortion but it may have below issues:
  - With some blanking area at some borders.
  - Display with full screen but some image will be stretched outside display borders and can't be seen.
- If user wants to change video wall display image aspect ratio, user needs to adjust Position Reference Line first. In this example, if user wants to stretch horizontal image, user needs to adjust TV3 and TV2 horizontal scaling factor first, then to align TV1 and TV4 to match TV3 and TV2 test pattern.

## 9 Flexible Aspect Ratio Adjustment

User can change the aspect ratio of the image with black borders or to stretch the image in specific direction to compensate the aspect ratio difference between video wall and the content. The Maximum adjustment range is 900 pixels in each edge.

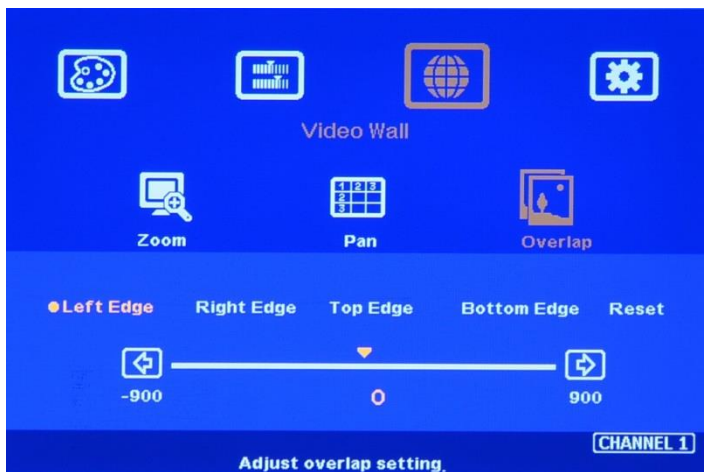
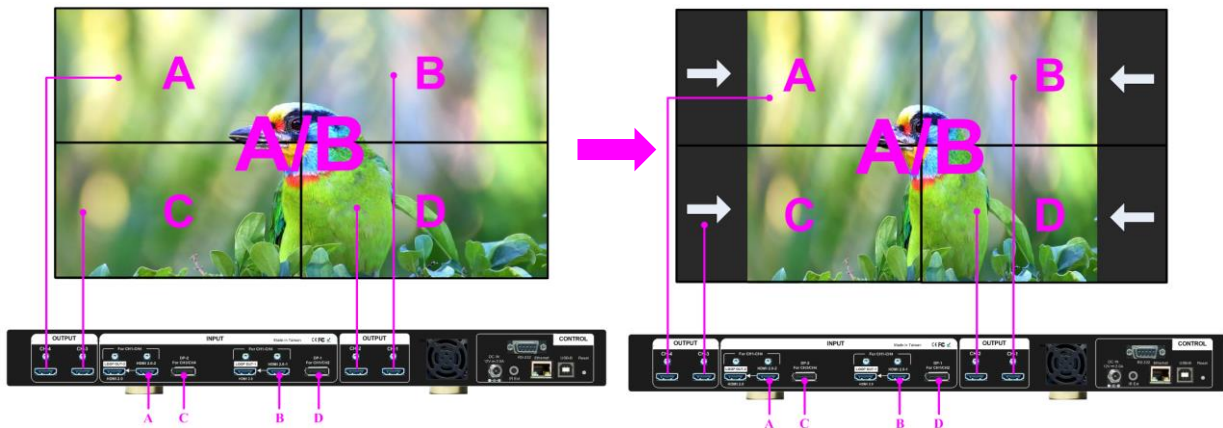

Activate [Overlap] under [Video Wall] menu

1. User can select the channel and the edge required for edge shift, then adjust Overlap value to see aspect ratio change.
2. The image position shift range is +\_900 pixels in each edge.
3. If Video Wall [Zoom] is set to H=1 & V=1, this function will be only functional under input signal up to 4k/2k @30Hz.

1. If the image is at portrait position, this function is still functional but the maximum input resolution is limited to 4k/2k @30Hz only.
2. The adjustment range 900 pixels is calculated based on signal source resolution.

## 10 Save System Settings through OSD Menu

- After finishing system settings, user can save the setting by OSD menu through [Menu]→ [Options]→ [Setting]→ [Profile]→ [Save]→ [Index 1-5]. **[Save] Profile will take effect for two channels in the same display group. User needs to Save CH1/2 & CH3/4 separately for one G-406.**
- User can recall the setting (Load) through IR remote controller or [Profile] hotkey on Front Panel.
- Five different display settings can be saved to [Profile]. The data stored in Profile include EDID setting, input source, output resolution, color settings and all user customized settings.



- When user power off the system, G406 will save user setting without loss even the setting is not saved into Profile Index, unless someone to change the setting.
- When system has been reset from OSD menu or update new Firmware, Profile data will still be kept inside G406.

## 11 Load Profile Index through Front Panel hotkeys

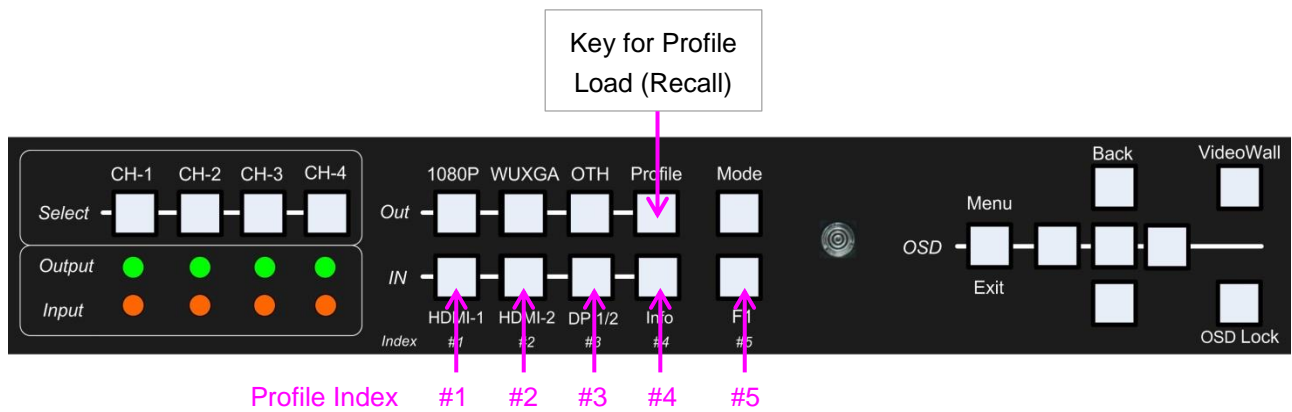

- Load Profile Index  
Push [Profile key]→ Select Index # on Front Panel. No [Enter] is required.
- Index # keys on front panel  
HDMI-1: Index 1, HDMI-2: Index 2, DP 1/2: Index 3, Info: Index 4, Align: Index 5
- No Profile [Save] shortcut key is available to avoid erasing by mistake.
- Profile Load will apply to all channels at the same time.

## 12 Load Profile Index through Remote controller

- Press [Profile] shortcut key→ Select number keys 1-5 to recall Index 1 – Index 5.
- Profile Load will apply to all channels at the same time.

---

## 13 Important notice for video wall settings

### 13.1 Image distortion and aspect ratio issues

If the content aspect ratio is different from video wall, it will cause image distortion. User can adjust aspect ratio through [Overlap] settings. However, you will have two choices:

- Full screen display but some content will be drawn outside border.
- Draw the image into video wall and keep some blanking borders at some edges.

13.2 If the signal is from PC, user can set customized EDID in GeoBox to let PC output the right output resolution. Some PC may not follow GeoBox EDID resolution and require customized output setting from display card.

13.3 User can set different video wall settings in each channel and crop different area for the display. In combination with ZOOM, PAN and OVERLAP settings, user can crop any location of the image for each LCD, no matter it is in landscape or portrait position.

13.4 Pay attention to image flip and rotation limitations in input resolution. G406 doesn't have image flip and rotation function when the input is 4k/60 Hz.

13.5 Some media players will output maximum resolution when it is powered on each time but not follow output resolution setting in the medial player or the EDID settings in GeoBox. It will cause abnormal display in the video wall if this video wall has image rotation of flip setting.

## 14 Easy Setting In Multiple Unit Application

### 14.1 Setup by Remote Controller

14.1.1 If multiple units are used, user can set different [Box ID] (#1 - #99) to each Box in control system.

For IR control, the number range is #1 - #9.

14.1.2 User can control individual GeoBox through below method when all boxes or IR extender receivers are installed together.

- ✓ Press 851 number key on remote controller will lock all other G406 OSD menu except ID #1 G-406. User can see flashing LED on the Front Panel for the units with OSD locked.
- ✓ Press 853 will only unlock ID # 3 G406 for further OSD operation.
- ✓ Press 850 will unlock all G406 OSD menu. Remote controller can access to all box simultaneously.

### 14.2 Setup by Ethernet

User can connect all G406 in one Ethernet (or WiFi) Router (or switch hub) Lan ports and set different Static IP address for each Box, then use WebGui virtual keys or UHDWall Manager PC tool to control each G406 independently. If user connects PC to the same Router and set Router with DHCP mode, PC can access to G406 directly. If PC is not connected with the same Router, user needs to set PC with the same Domain Segment as G406 for Ethernet connection. Web Server function is also available, Please contact us for more details.

14.2.1 WebGui

- ✓ WebGui is embedded inside G406. Once user connects G406 with PC through Ethernet, user can access WebGui and execute all operation similar to OSD menu through Virtual Keys and OSD Menu. No PC tool is required.
- ✓ The connection can go through Ethernet router LAN port, WiFi Router or Cross Over Cab 5/6 cable. User can set each unit of G406 with different static IP address in the same domain, then open Google Chrome or Microsoft Explorer with IP address to access each unit of G406 for independent operation. There is no limitation in the number of G406 that can be controller at the same time.
- ✓ User can turn on/off the system through WebGui and see the status through power indicator.

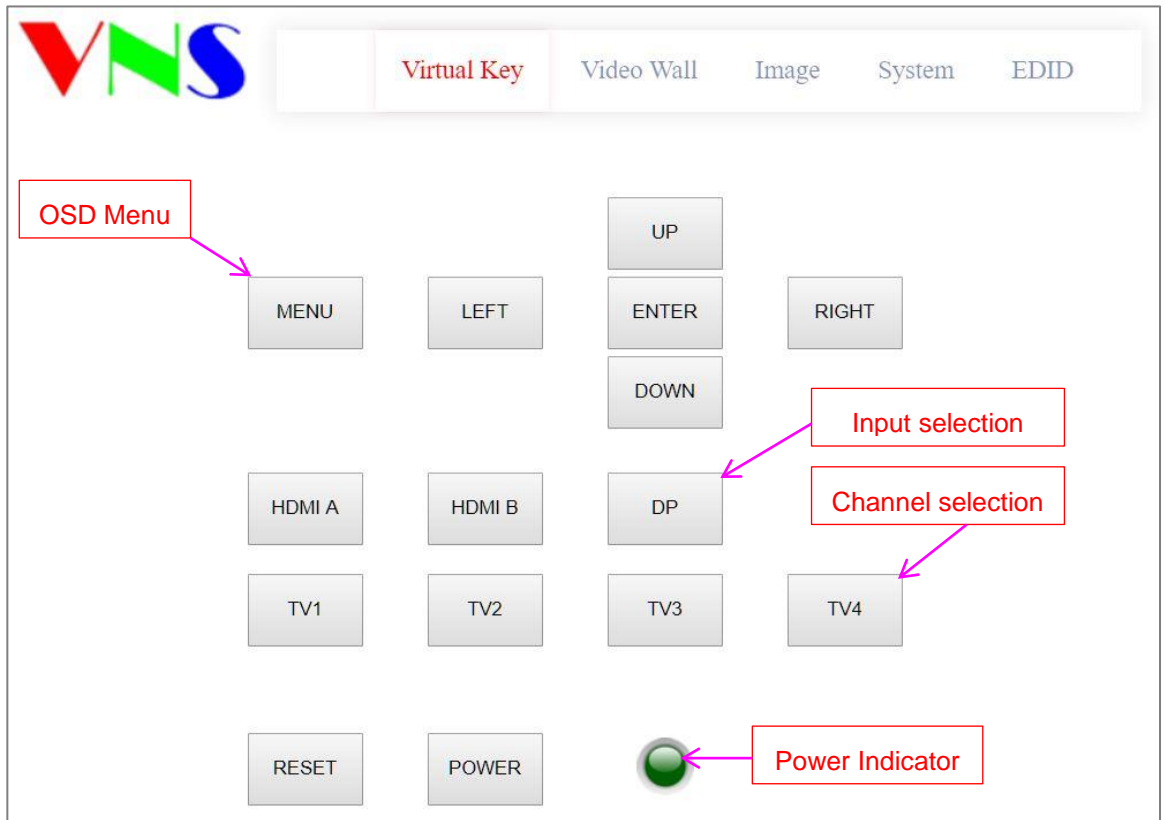



14.2.2 UHDWall Manager PC Tool

- ✓ UHDWall Manager is a PC tool executed through PC. User needs to download this tool from VNS website. Once user connects G406 with PC through Ethernet and open UHDWall Manager, user can access UHDWall and execute all operation similar to OSD menu through PC keyboard and mouse. User can also backup system setting in PC and restore/copy to other units.
- ✓ User can execute full operation functions and also update Firmware and MCU code through UHDWall. User can control multiple units at the same time through change IP address.

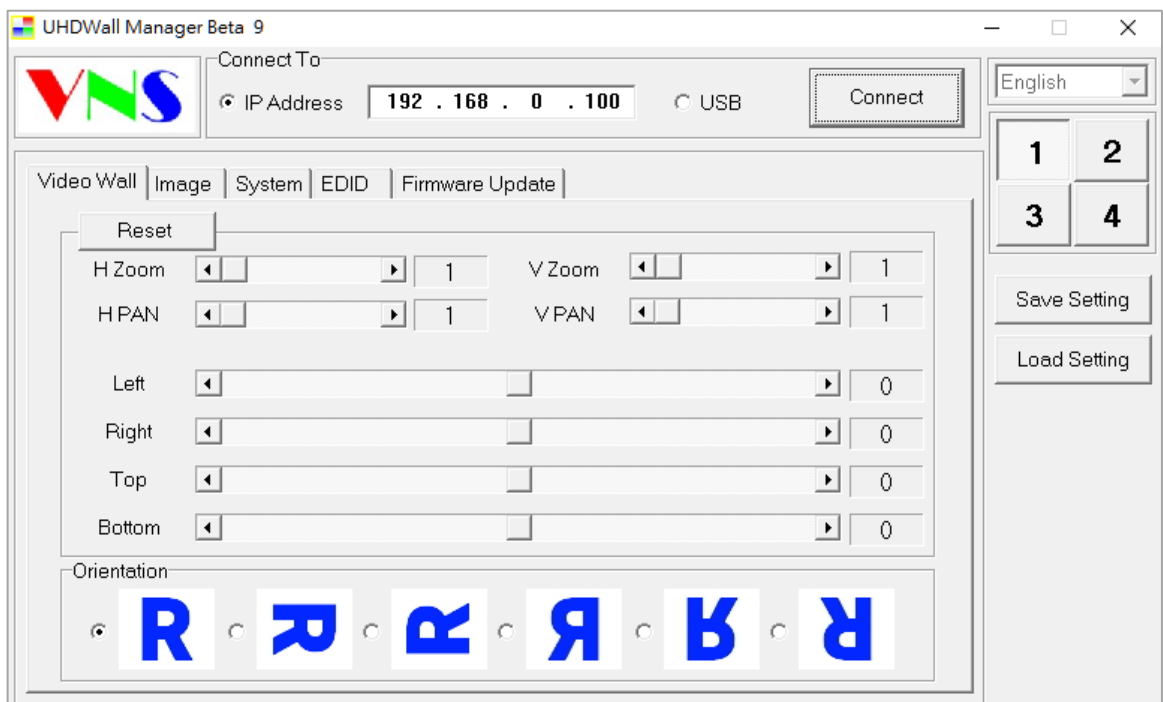

## 15 System Structure and Control

RS232 and Ethernet are available for system control. They can be used simultaneously to provide the most flexibility in system control.

### 15.1 System Structure: Group A & Group B

- G406 can be treated as one quad channel processor or two dual channel processors. Channel 1/2 is called Group A and channel 3/4 is called Group B.
- HDMI-1 & HDMI-2 input signals can be connected to Group A & B.
- DP1 is sole for Group A and DP2 is sole for Group B.

### 15.2 OSD Command Execution in Group A & Group B

- The following command will be applied to all channels in Group A & Group B at the same time.
  - [Profile]→[Load]→[Index]
  - [Options]→[Setting]→[Box ID]: one G406 has one Box ID and can only be set by CH1 or CH2.
  - [Options]→[Setting]→[Mute]
  - [Options]→[Setting]→[Network]: one G406 has one Network setting and can only be set by CH1 or CH2.
- The following commands will be applied to CH1, CH2, CH3 & CH4 independently.
  - Color adjustment: All menu under [Picture]
  - [Image Properties]→[Color]
  - [Image Properties]→[Input Signal]
    - DP-1 can only apply to CH1/2. DP-2 can only apply to CH3/4. Each display Group can't select HDMI-1 & HDMI-2 at the same time. Please see Section 2 for more details.
  - [Image Properties]→[Orientation]
  - EDID setting in DisplayPort 1/2, any channel with DisplayPort input can set EDID
- The following commands will be applied to Group A and Group B separately. The commands will apply to two channels inside the same display Group.
  - [Image Properties]→[Scaling]: select full screen or original aspect ratio
  - [Image Properties]→[Output Mode]: select output resolution
  - [Options]→[Information]: show system information
  - [Options]→[Language]: select OSD language
  - [Options]→[Reset]
  - [Options]→[Accessibility]→[OSD Time Out]
  - [Options]→[Accessibility]→[Logo Time Out]
  - [Options]→[Accessibility]→[Standby Time]
  - [Options]→[Accessibility]→[Black Screen]
  - [Options]→[Setting]→[Mute]
  - [Options]→[Setting]→[Profile]→[Save]
  - [Options]→[Setting]→[Profile]→[Load]: If via [Menu]→[Setting]→[Profile]→[Load] process, the result will apply to CH1/2 or CH3/4 but not all channels. If via [Profile] hotkey on front panel or remote controller to Load Index, the result will apply to all channels at the same time.

### 15.3 EDID Setting

- [Options]→ [Setting]→[EDID]
- HDMI-1 & HDMI-2: select CH1 or CH2 with HDMI input, then to set EDID
- DP-1 & DP2: select CH1 or CH2 for DP-1, then to set EDID. Select CH3 or CH4 for DP-2, then to set EDID.

### 15.4 HDMI vs. DVI Output Signal

HDMI digital signal is compatible with DVI signal. Most of display devices can support both digital signals. However, some old equipment may have less flexibility in digital input signal compatibility. In this case, user may need to select DVI output format for normal display.



### 15.5 System Standby and Automatically Turn Off Output Signal

- [Options]→ [Accessibility]→[Standby Time]
- If set [Standby Time] at 60, the system will get into Standby Mode after 60 seconds when no input signal is detected. The output signals from G406 will also be terminated at the same time. If G406 detects input signal again, it will automatically turn on the system again.
- If the monitor has automatically turn off/on function by detecting input signal, user can control signal source to execute entire system on/off control.

### 15.6 RS232 Setting

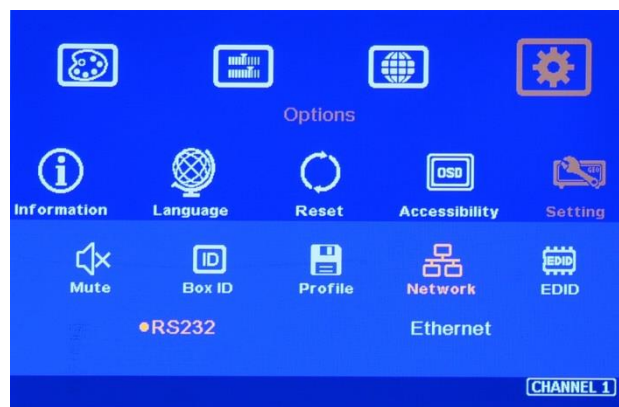

- RS232 interface is designed with DB-9 connector. User can select 11520 or 9600 baud rate.
- The UART Protocol between GeoBox and a Host computer can be provided. The protocol can be implemented via RS-232, USB, Ethernet or other forthcoming communication methods.

## 15.7 Ethernet Setting

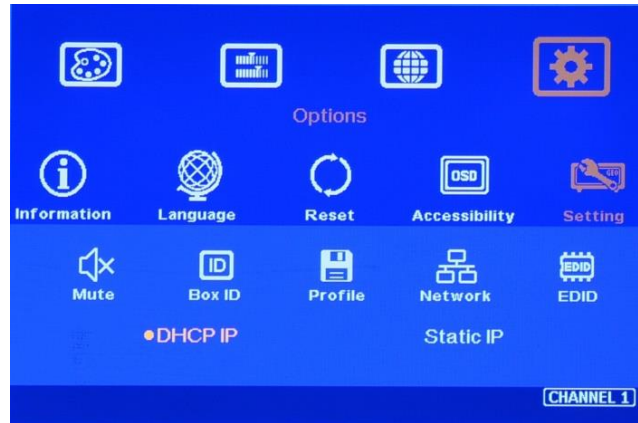

- Ethernet control: GeoBox is integrated in G406 via RJ45 connector. User can controller G406 through Ethernet or WiFi via PC or mobile devices. A WebGui with keypad icons (virtual keypad) will be showed in control devices for user to control the OSD function of G406.
- UHDWall Manager PC tool is available for full function operation and firmware & MCU code update.
- DHCP & Static IP can be set in each G406 for independent operation.
- User can use < > OSD direction keys to access the position for the modification and ^ v OSD direction keys to change the IP address settings.
- If WiFi router is connected, G406 can be controlled through WiFi by PC, mobile phone or iPad.
- Please connect G406 to Lan port of WiFi Router. Once execute correct WiFi settings in WiFi Router, user can access G406 by PC, Notebook, mobile phone or iPad and control it through WebGui or UHDWall Manager.

## 15.8 Change Background Color

When no signal input, the system will show blue color background with [Power Saving Mode] message on the screen. User can change background color to black from the OSD menu as below.

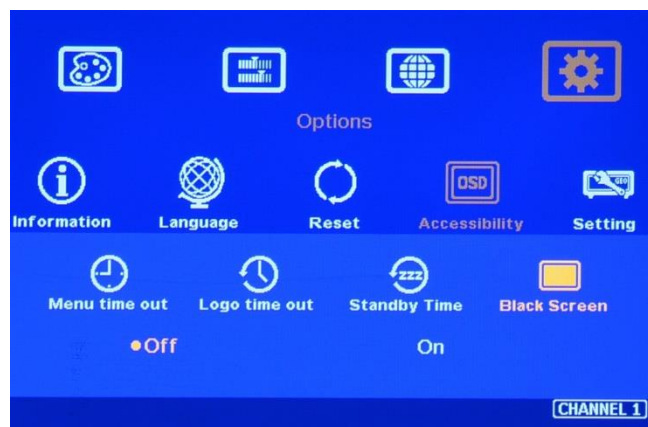

## 16 Limitations in Image Flip and Rotation

Image 90/270 degrees rotation and image flips are only available in input resolution under 4k/2k @30Hz (included).

## 17 Limitation in Audio Output



---

User can only select one audio output from each display group - Group A (CH1/CH2) and Group B (CH3/CH4). In each Group, if both HDMI and DP input are selected, then only HDMI audio will be selected as audio output.

## 18 Trouble Shooting

### 18.1 Front Panel LED lights

User should see Input/Output LED lights in each operation channels. If no light illuminated in specific channel, please check Input/Output connecting cables, signal source & monitor in that channel.

### 18.2 Intermittent or Loss of Input Signal

- Check the HDMI cable quality and make sure all cables are fitted correctly. 4k/60 signal requires high speed certified cables.
- Cable length: Connecting cable length should be short as possible. Replace a short cable to verify the possible root cause.
- HDCP compliant issues: If the input source or the monitors are not HDCP compliant, it is possible to stop G406 from negotiating HDCP link and show intermittent, abnormal or no image.
- Bit Rate or resolution issues: check if signal source and connecting cables can provide right resolution and enough bit rate signal requested by G406.
- **DVI/HDMI signal compatibility: some display devices may only support HDMI or DVI video signal and execute wrong signal format detecting. The default output is HDMI. User can change output with DVI format through [Options]→ [Setting]→ [DVI]→ [On].**
- Usually, to swap with different cable, output channel, signal source and monitor can verify the root cause for the failure.
- When it is possible to have signal compatibility issue, user can add one HDMI splitter or switch in the middle to change signal impedance. It may fix the issue.

## 19 Technical support

- User can send e-mail to [support@vnstw.com](mailto:support@vnstw.com) with as much information as possible.
- The following information is required for a swift response.
  - Display device: type and model number
  - Monitor array or specific application details.
  - GeoBox model No. and series No.
  - Detailed timing of signal source and resolution.
  - Press [Info] key to get System Information and send the data to us, including F/W version.
  - The exact nature of the problem. Please be as detailed as possible.
- Usually we will response with 24 hours (excluding weekends)

## 20 Safety Precaution and Maintenance

### 20.1 Power Supply

Please connect electric power for all devices in the system from the same Power Distribution Box with correct grounding. Open the power after finishing system connection to reduce the risk for system damage from high floating voltage.

## **20.2 Working Environment**

Please locate G406 in an environment free from dust, moisture and high temperature with good ventilation.

## **20.3 Warranty:**

This device is designed and tested to the highest standards and backed by two years' parts and labor warranty. Warranties are effective upon the first delivery date to the end customer and are non-transferable. Warranty period extension is available up to 5 years through paying extra charges.

## **20.4 Maintenance and Repair**

Apart from what is detailed in User Guide, maintenance should be carried out by competent technician assigned by VNS. If G406 is physically damaged, it should be returned for repair using VNS RMA procedures. If the unit is opened by user, it will lose the right for warranty protection.

---

## **Specifications**

- ✧ Input: 2x HDMI 2.0b for all channels, 1x DP1.2a for CH 1/2, 1x DP1.2a for CH 3/4
- ✧ Output: 4x HDMI up to 1080P & WUXGA
- ✧ 2x HDMI 2.0 loop out ports for multiple unit cascade & daisy chain connection
- ✧ HDMI: HDCP V2.2/V1.4, DP: HDCP: V1.3
- ✧ Max. input resolution: 4096x2400 @60Hz for both HDMI 2.0 & DP 1.2
- ✧ Support non-VESA STD input timings
- ✧ Support pixel to pixel 8k/4k display
- ✧ Selectable output up to 1920x1200 60Hz
- ✧ 10-bit processor, frame rate conversion
- ✧ 4:4:4 Chroma sampling, 30 Color bits, 12-bit RGB gamma CLUT
- ✧ Support sRGB & xvYCC color processing & 8/10/12-bit deep color
- ✧ 3:2/2:2 cadence, low angle smooth algorithm, high quality scaling engine
- ✧ 3D motion adaptive de-interlace
- ✧ Frame lock for synchronized outputs
- ✧ High Dynamic Range (HDR) support: SMPTE ST-2084, SMPTE ST-2086
- ✧ Individual 90/180/270 rotation, flip, cropping, scaling & color adjustment in each channel
- ✧ Matrix switch for multi-window display
- ✧ Embedded HDMI/DP audio in each output
- ✧ Selectable and programmable EDID
- ✧ ESD Protection:  $\pm 8kV$  (Air-gap discharge),  $\pm 4kV$  (Contact discharge)
- ✧ DC 12V/1.1A, max. 13w, (100-240 VAC PSU)
- ✧ Working environment: 45 ° C, 10-90% RH
- ✧ Control: Front panel keypads, IR, RS232, USB, Ethernet
- ✧ Dimensions: 440mm\*194mm\*45mm, Weight: 2.2kg
- ✧ CE/FCC/RoHS/Green Certified
- ✧ 2 Year Warranty, paid extension is available

---

### **Revision History**

Revision	Date	Originator	Comments
V1.0	2018-01-16	Steve Wang	First version
V1.1	2018-01-17	Steve Wang	Change front panel silk printing
V1.2	2018-01-18	Steve Wang	Modify Load/Save Profile
V1.3	2018-02-17	Steve Wang	Add irregular video wall setting and Ethernet control
V1.4	2018-0315	Steve Wang	Add New Overlap for aspect ratio adjustment