

8x8 Seamless UHD Matrix

Model No. MXB88H



Warning

- Do not expose this device to Rain, Moisture, and Dripping
- Only use accessories specified by the manufacture
- Unplug this device during Lightning Storms
- Product specifications may be subject to technical upgrades without further notice

● 1. Introduction

MXB88H is a high-performance seamless UHD matrix switcher with 8x HDMI inputs and 8x HDMI outputs. Audio extract or insert can also be enabled on this device. IR matrix routing on this video matrix is followed with video routing

MXB88H key features:

- Support HDMI 2.0/HDCP 2.2
- Support seamless switching
- Support IR matrix
- Support HDMI audio extract
- Support external LR audio insert on HDMI stream
- Support EDID management
- HDMI video output resolution:
3840x2160@60, 3840x2160@30,1920x1080@60,1280x720@60,
1920x1200@60,1360x768@60,1280x1024@60, 1024x768@60
- Front panel,RS232,TCP/IP (LAN 10M/100M) control

2. Front Panel Control

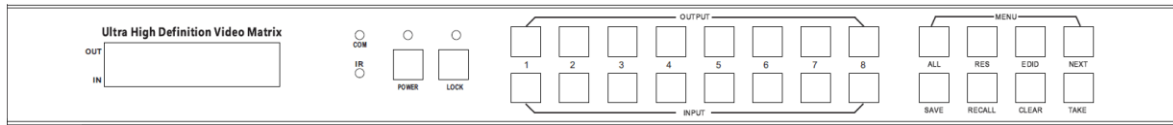

- OUTPUT/INPUT buttons

Press buttons OUTPUT n + INPUT m+ TAKE by sequence, user can switch matrix routing

- Press button POWER , to make the matrix enter or release standby state. When standby, the power LED will be lighted

- Press button LOCK, to lock or un-lock front buttons. When locked, the Lock LED will be lighted

- Press buttons ALL + INPUT m + TAKE by sequence, to switch input m to all the outputs

- Press button SAVE + OUTPUT n to save current routing scene as scene n. The maximum allowable scene No. is 8

- Press button RECALL + OUTPUT n to recall routing scene n as current routing

- Press buttons RES + OUTPUT n + NEXT + TAKE, to change output resolution of OUTPUT n port

Resolution option :

3840x2160@60, 3840x2160@30,1920x1080@60,1280x720@60,

1920x1200@60,1360x768@60,1280x1024@60, 1024x768@60

- Press buttons EDID + INPUT m + NEXT + TAKE, change the EDID mode of port INPUT m

EDID option: Manual,3840x2160@60, 3840x2160@30, 1280x1024@60

1920x1080@60,1280x720@60,1920x1200@60

3. Back Panel

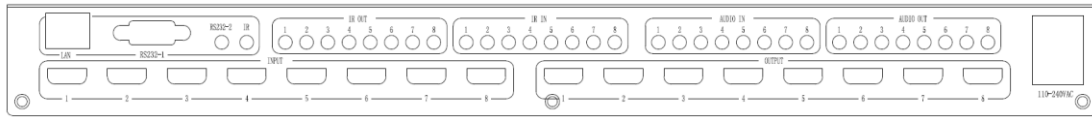

- LAN(10M/100M), RS232 are for PC control
- Analog Audio IN/OUT ports are bond with corresponding HDMI ports .

For example, if INPUT HDMI 1 signal is **DVI**, matrix will use analog AUDIO IN 1 as HDMI 1 audio source

Note, Analog AUDIO IN is only available when the corresponding video input is DVI signal.

Analog AUDIO OUT n will always output the same audio content with HDMI OUTPUT n

Analog Audio IN/OUT connection

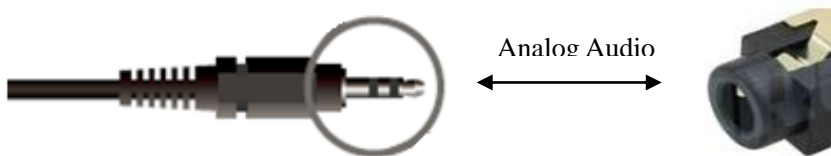

- IR IN and IR OUT

IR IN/OUT is for remote control routing, and followed with video routing,

For example, if input HDMI m is routed to output HDMI n1 and n2 ports, then

IR IN n1 and n2 ports will be routed to IR OUT m port. Please refer to bellow illustration.

Relationship between video and IR routing

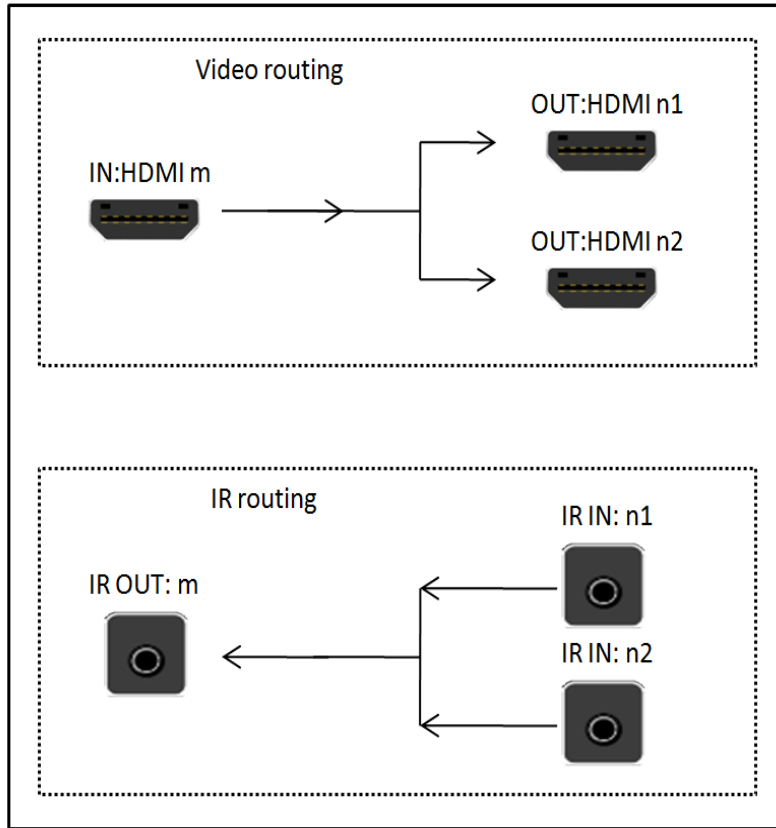

IR extender connectors (not as accessories)

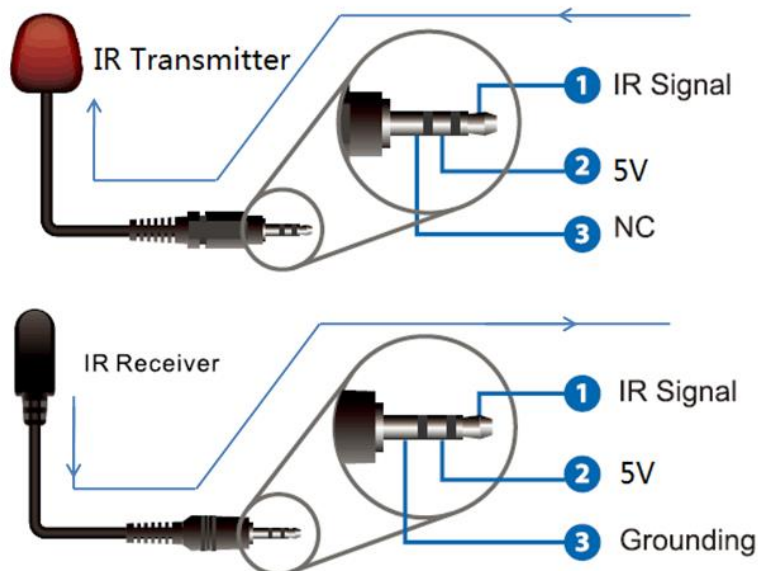

4. PC Tool and RS232/LAN Control

4.1 RS232 connector

- RS-232 control, baud rate 9600, DB9 connector
- Pins configuration as bellow. User need use the corresponding cable, directly link cable

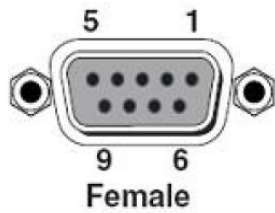

Index	Pin
1	N/u
2	Tx(Matrix →PC)
3	Rx(Matrix ←PC)
4	N/u
5	Gnd
6	N/u
7	N/u
8	N/u
9	N/u

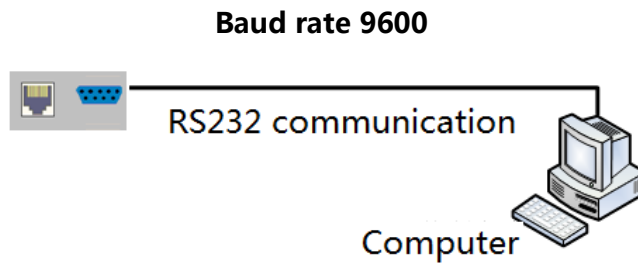

4.2 Ethernet control and connection

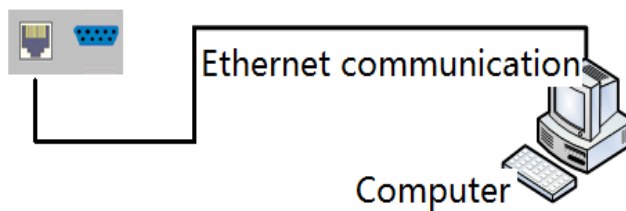

Note : Factory default network setting :

IP Type	Static IP
Static IP	192 . 168 . 0 . 247
Subnet Mask	255 . 255 . 255 . 0
Gateway	192 . 168 . 0 . 1

4.3 PC Tool

The PC tool needs no installation, support serial control and network control.

Please note, Fine Tune/OSD CTRL/TV Wall pages are reserved for future used

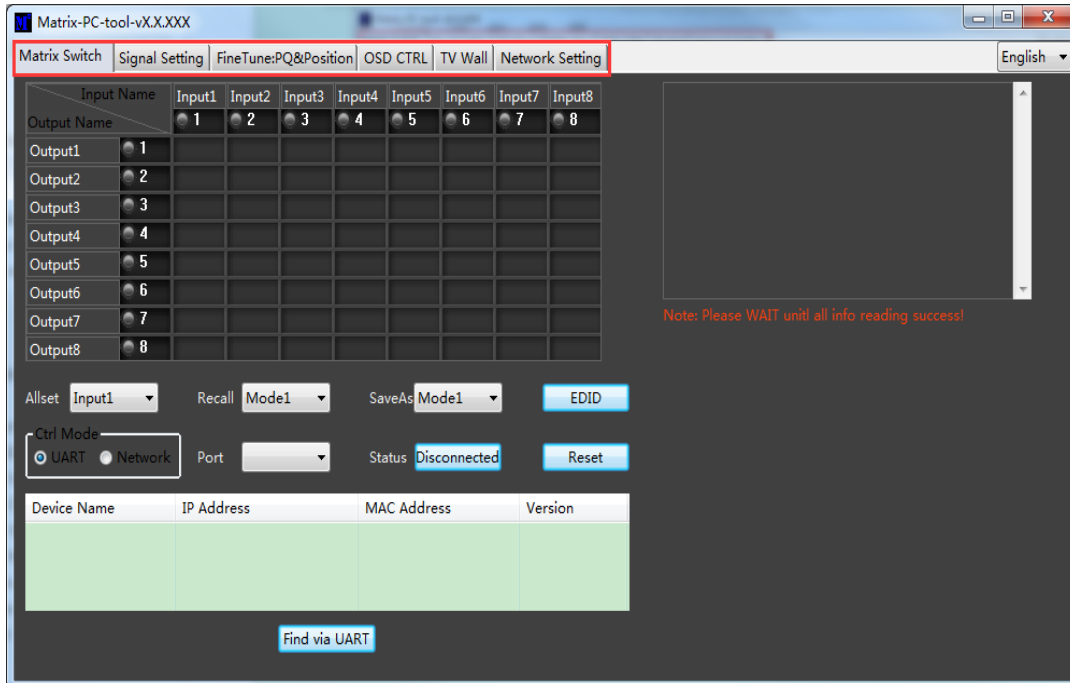

● 4.3.1 UART Control

Control steps as follows:

1. Connect PC and device with a straight serial port cable
2. Run PC control tool and switch to "Matrix Switch" page
3. Click to switch "Ctrl Mode" to "UART"
4. Click the combo box which is right to the "Port", select the right COM port (There may be some COM ports connected to the PC)
5. Click the "Disconnected" button (which is right to "Status") to connect to the device
6. If connected successfully, the "Disconnected" button will show "Connected"

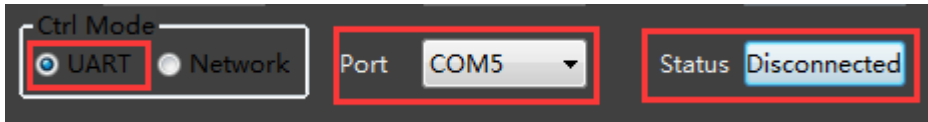

The UI after connected successfully will be as follows:

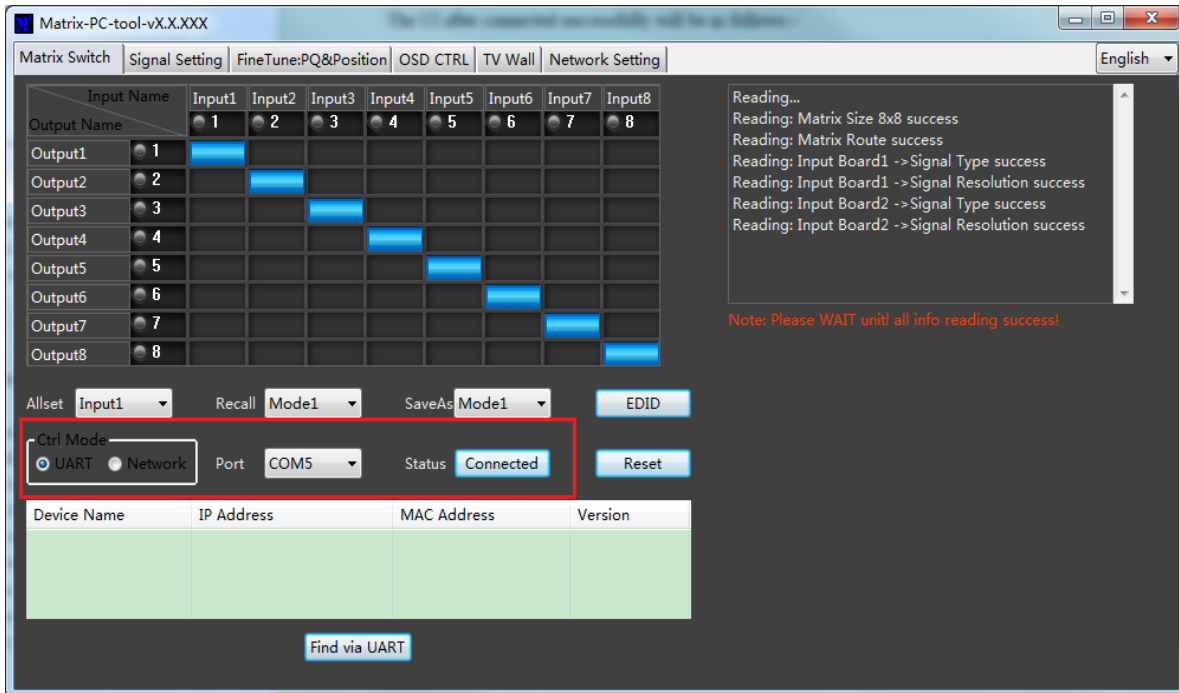

- 4.3.2 Network Control
- Direct connection via Ethernet cable

Control steps as follows:

1. Connect the PC and device directly via an Ethernet cable
2. Manually setting up the IP address of the PC, and the IP address of the PC and the device should be in a same network segment (The default IP address of the device is 192.168.0.247, and the default network mask of the device is 255.255.255.0). The

screenshots of setting up the IP address are as follows:

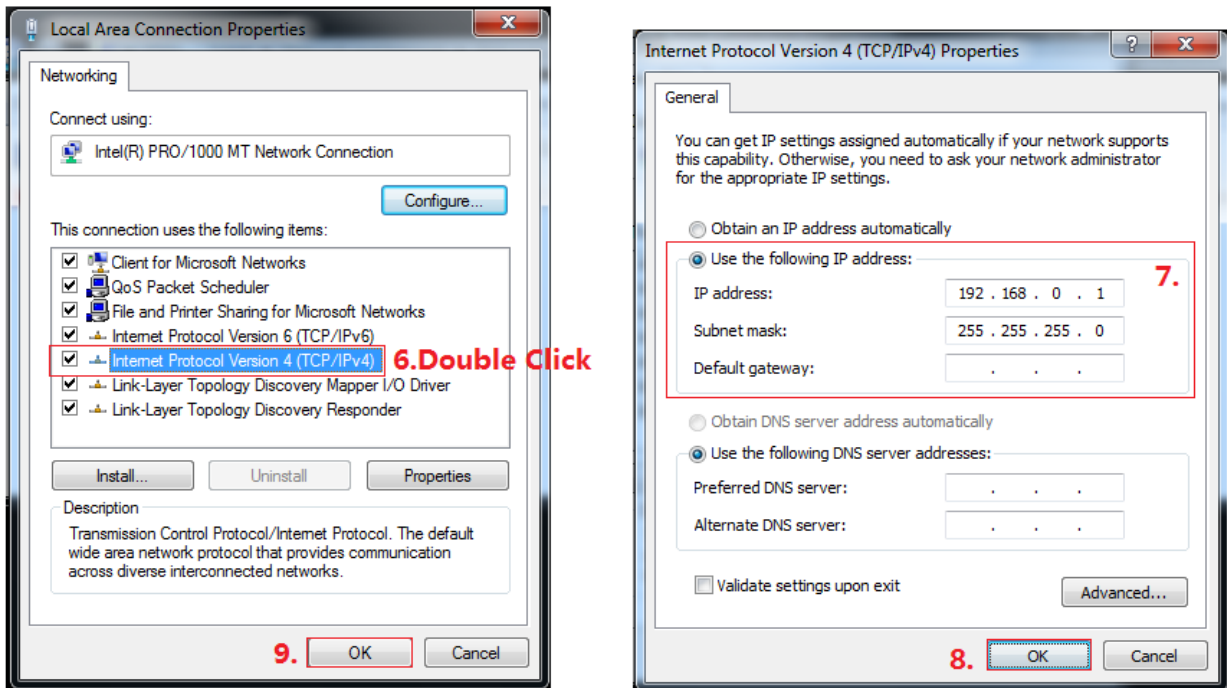
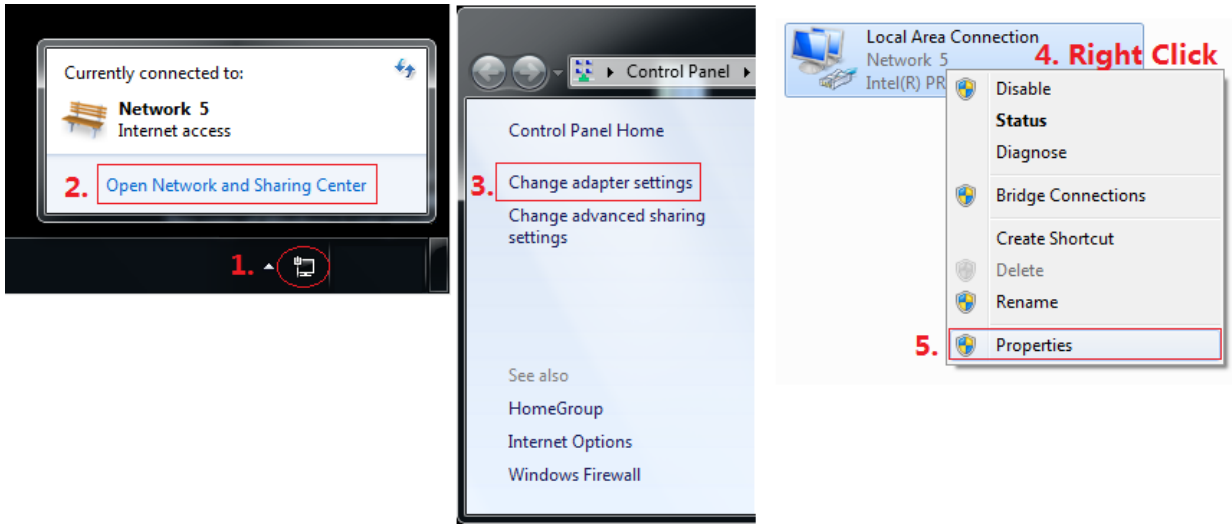

Manually setting up the IP address of the PC

3. Run the PC control software (If the IP address of the PC changed after running the software, you should close it and run it again)
4. Click to switch "Ctrl Mode" to "Network"
5. Click the "Search Device" button
6. Click the device you want to control in the result list (When you click it, the software will

read the network configuration such as network port and so on of the device automatically)

7. Click the 'Disconnected' button (which is right to "Status") to connect to the device
8. If connected successfully, "Disconnected" button will show "Connected"

The UI after connected successfully will be as follows:

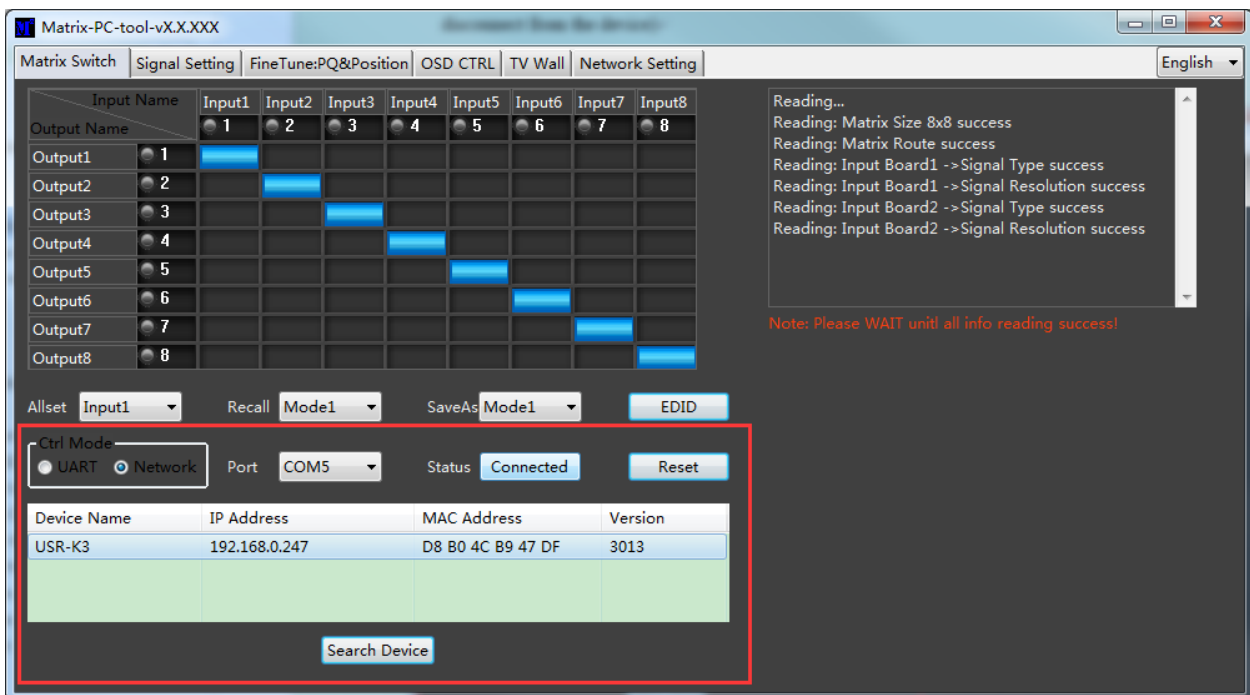

- Connection via LAN

Control steps as follows:

1. Connect the PC and the device to a same network router
2. Setting up the IP address of the PC. Either manual(Static) mode or automatic (DHCP) mode is ok. Just make sure the IP address of the PC and the device are in a same network segment (When the IP type is obtain automatically, the network router that PC and device connected to should support HDCP function)

3. Run the PC control software (If the IP address of the PC changed after running the software, you should close it and run it again)
4. Click to switch "Ctrl Mode" to "Network"
5. Click the "Search Device" button
6. Click the device you want to control in the result list (When you click it, the software will read the network configuration such as network port and so on of the device automatically)
7. Click the 'Disconnected' button (which is right to "Status") to connect to the device
8. If connected successfully, "Status" button will show "Connected"

- 4.3.3 Configure the network module of the device

1. Configuration via UART

Step A: Connected to the device via serial port cable at "Matrix Route" page.



Step B: Switch to "Network setting" page

Step C: Click "Find via UART" button to read the configuration of the device

Step D: Modify the IP address or the IP address type

Step E: Click the "Save Config" button to save modification

Step F: When the software shows a message of "Success", Click "Find Via UART" to load configuration again to make sure your modification is saved successfully.

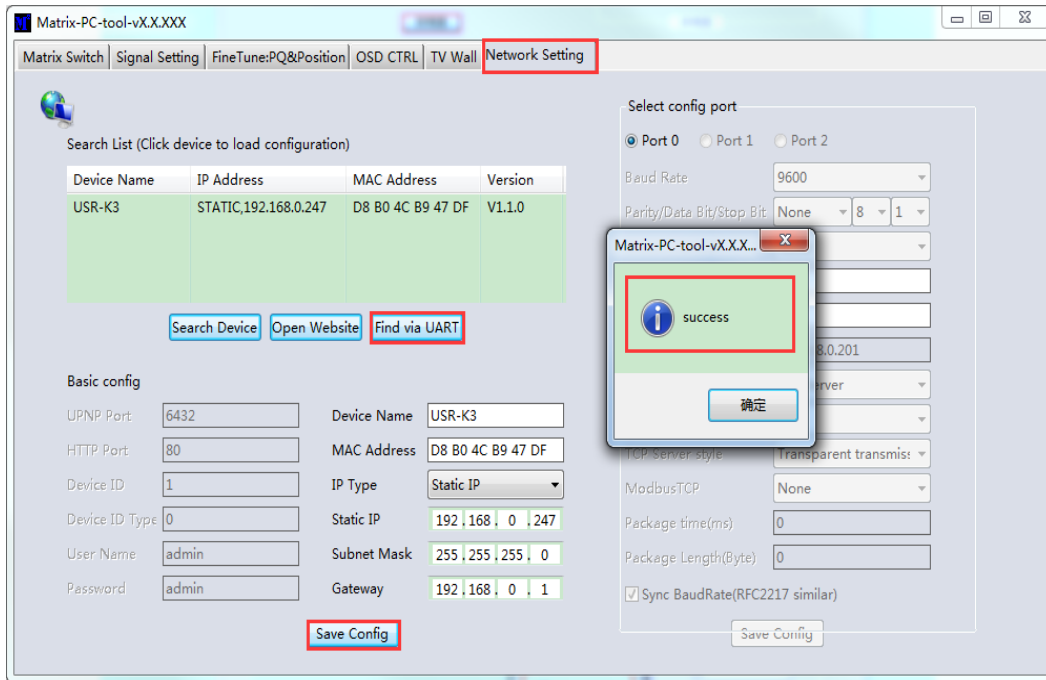

2. Configuration via Network

Step A: Switch to Ctrl Mode to "Network" page

Step B : Click the "Search Device" button to search devices

Step C : Click the device you want to configure in the result list (When you click it, the software will read the network configuration of the device automatically)

Step D : Modify the IP address or the IP address type or other configuration.

Step E: Click the 'Save Config' button to save data

Step F: When the tool shows message with "Success", Click "Search Device" button to search and load configuration again to make sure your modification saved successfully

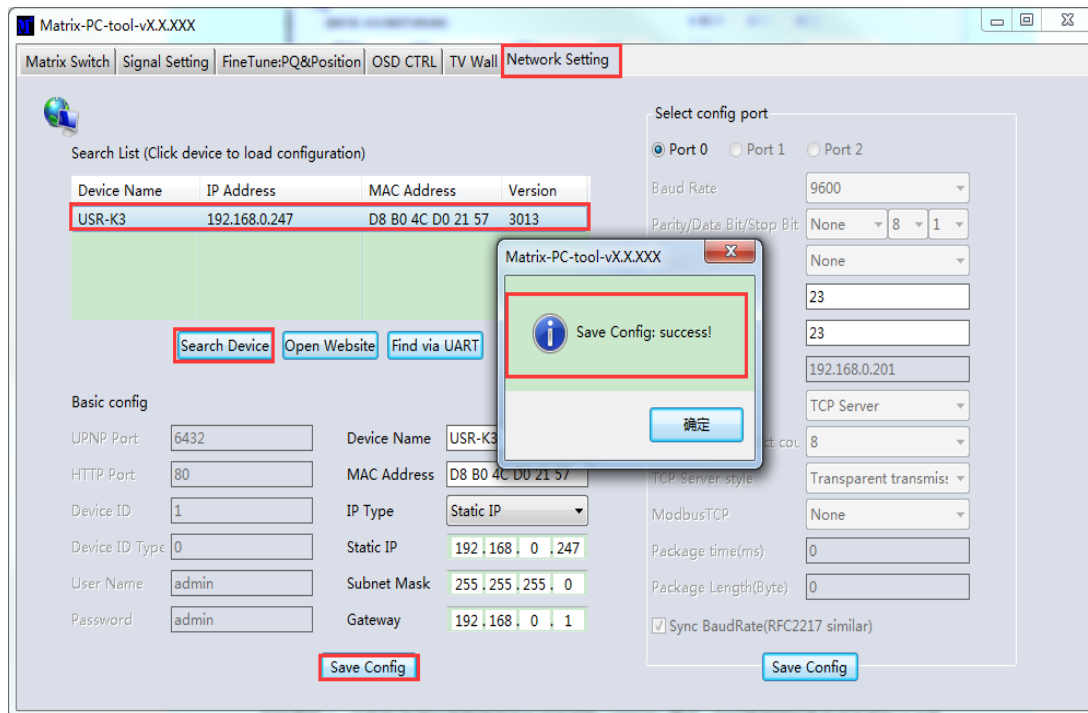

NOTE :

1. Select the device, will display the matrix's network board information. User can edit the device' s name, in order to better identify matrix. User can set dynamic IP/ static IP, subnet mask, gateway and other network information. At the same time, user can also set the device port. Serial port baud rate is 9600 (the user cannot change the baud rate, otherwise it will lead to the network control failed).
2. Configuration via UART only support modify IP address or IP address type. If you want to modify other configuration, please configure it via Network

● 4.3.4 Matrix Switch

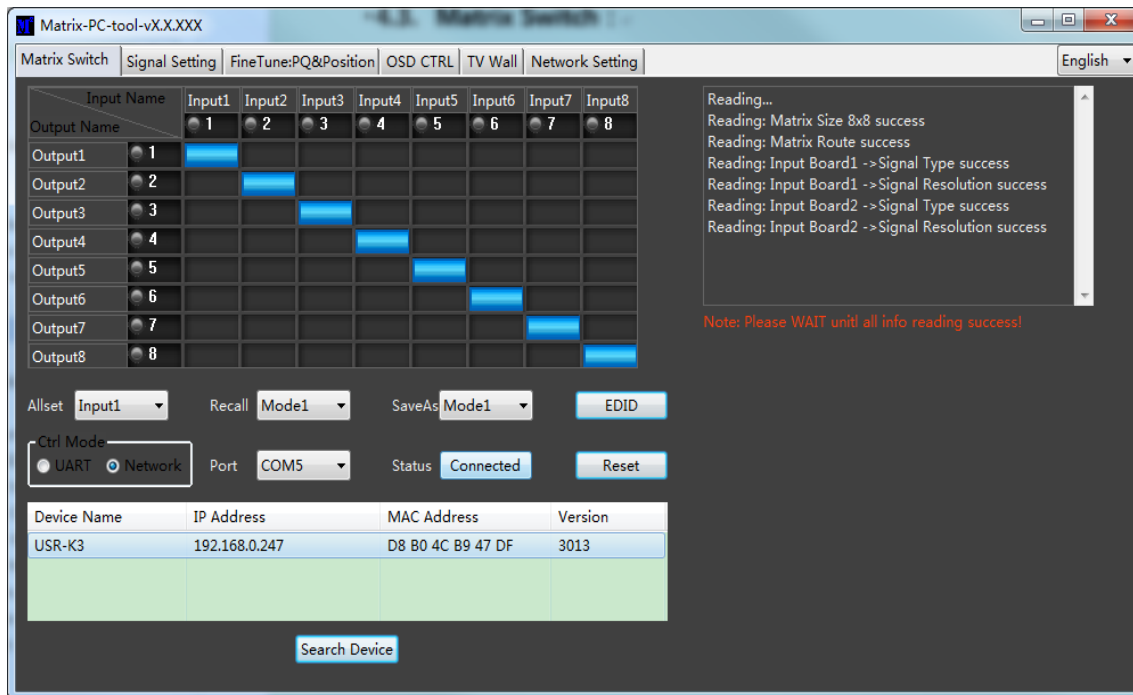

When the PC-tool connect to the matrix via UART or Network, the PC-tool will display the matrix' s input and output information.

1. User can click the mouse to switch the input; Can edit the input source name (for example, the user can edit the input 1 name to set-top box); Can also edit the output name to show which sink is connected (for example, the output 1 users can edit the name to TV)
2. Support scene save (the user can pull down the corresponding drop-down menu, to save the current input and output relationship to mode X, support 8 different modes)
3. Support scene recalls (the user can drop down the corresponding drop-down menu, to set the mode X input and output relationship to the matrix)
4. Support one input output to all outputs(the user can drop down the "Allset" drop-down menu, to set the input X output to all the output ports)
5. Support system reset: click "Reset" button, after the user confirmed, then will reset the matrix to the factory default settings

- 4.3.5 Signal Setting

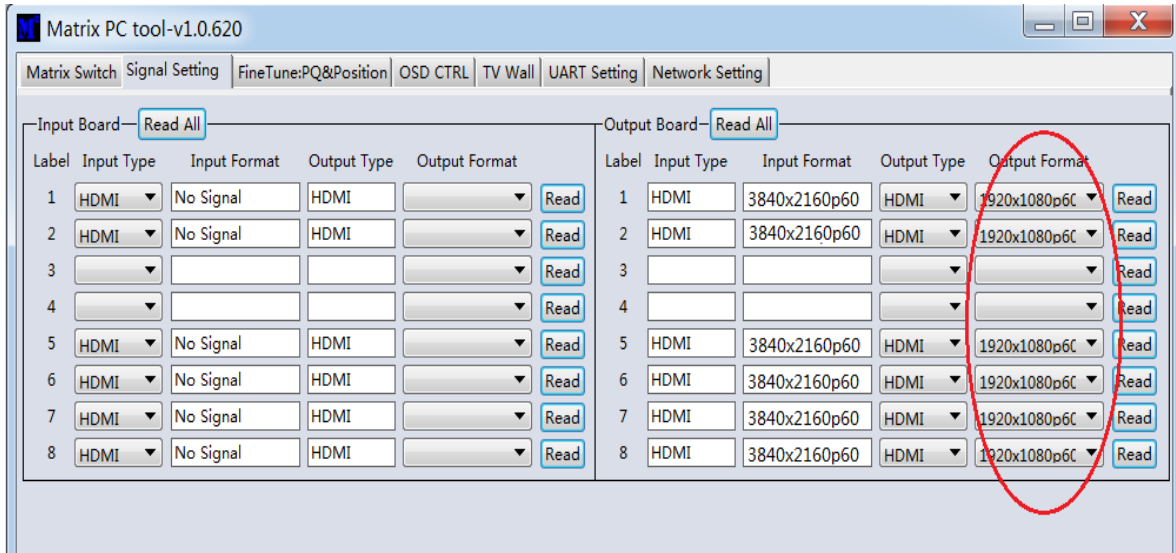

Only the red field can be changed for different output resolution, others are only for read

- 4.3.6 EDID control

Click the 'EDID' button on "Matrix Switch" page, open EDID control Window

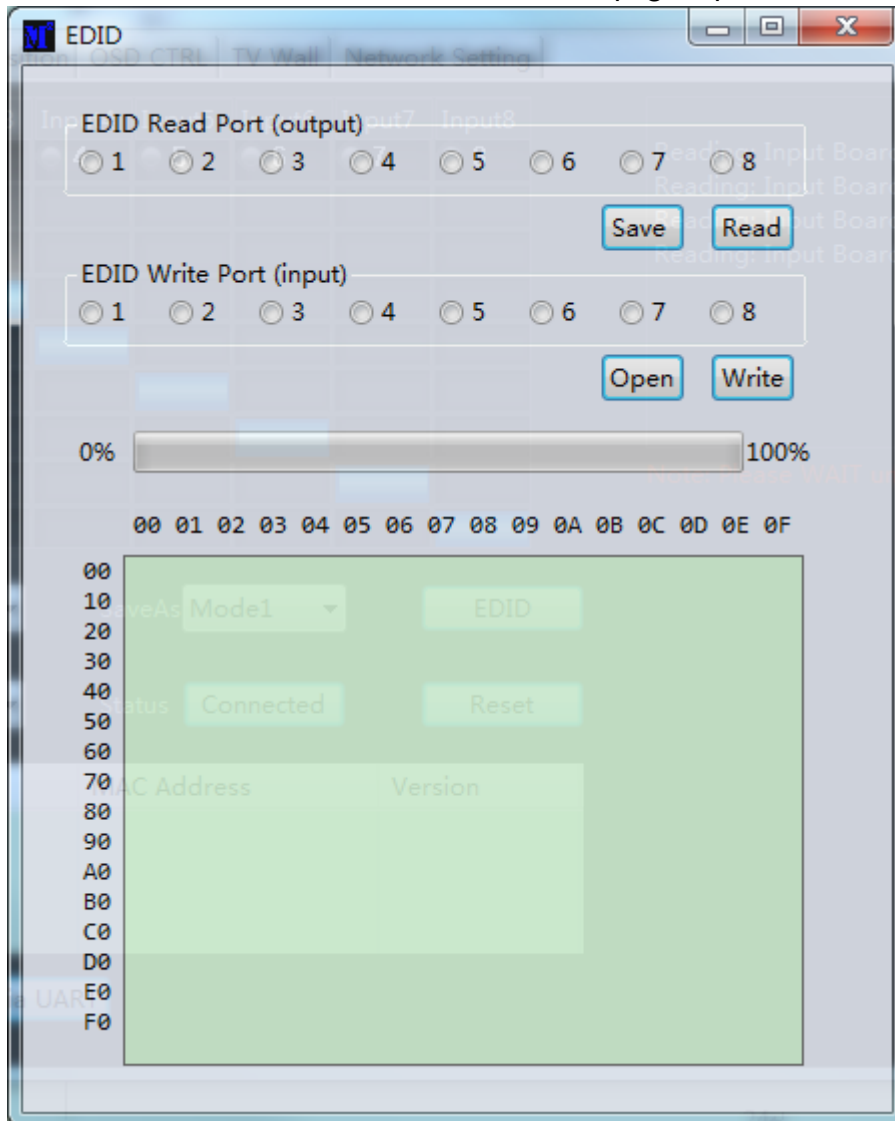

1. Read EDID : Select the output port, then click the "Read " button to read EDID
2. Write EDID : First read a EDID from output port , or open a EDID file that saved before , then select the input port , and click the "Write" button to write EDID
3. Save EDID : After reading EDID successfully , Click "Save" button, and select the save path and file name for saving.
4. EDID Manual: The written EDID above will be as the manual EDID data. When user select EDID mode with Manual mode by front panel for one input port, matrix system will use this data as the EDID data for the port

5. Control via Web

- If do not know the matrix IP address: Click on the Network Settings page, and then click Search Device, and then select the device that found, click Open Website to open the web control web site, or can input the IP on the web browser , then enter the username: admin Password: admin, then can control the matrix switch function use the website;
NOTE: The computer IP and matrix IP must be in the same segment and the same local area network; For example, the matrix' s IP is 192.168.1.xxx, then the computer IP must be 192.168.1.yyy; Otherwise need to change the matrix' s IP or the computer's IP. The browser must support HTML5 feature, which must be IE10 and above.

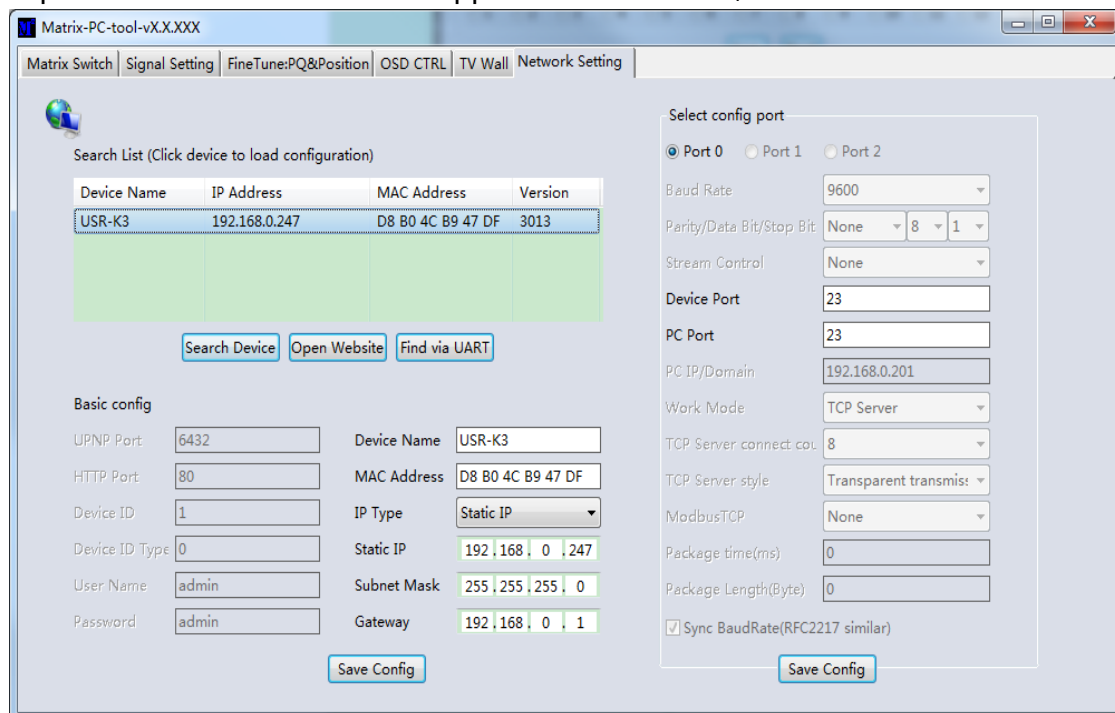

- If the matrix IP address is known: Input the IP on the web browser, then enter the username: admin Password: admin, then can control the matrix switch function use the website;
Note: the browser must support HTML5 feature, which must be IE10 and above

6. Electrical parameters

Electrical parameter	
Interface	HDMI-A
HDMI /DP /VGA Version	HDMI2.0,HDCP2.2
Bandwidth	18Gbps
Video Resolution	
Input	800x600@60Hz,1024x768@60Hz, 1280x768@60Hz,1280x800@60Hz, 1280x1024@60Hz,1360x768@60Hz, 1366x768@60Hz,1400x1050@60Hz, 1440x900@60Hz,1600x1200@60Hz, 1680x1050@60Hz, 1920x1200@60Hz. 480p,576p,720p,1920x1080i,1920x1080p, 3840x2160@24Hz/25Hz/30Hz/50Hz/60Hz, 4096x2160@24Hz/25Hz/30Hz/50Hz/60Hz.
Output	1920x1080@60Hz, 3840x2160@30Hz, 3840x2160@60Hz, 1280x720@60Hz, 1024x768@60Hz, 1360x768@60Hz, 1600x1200@60Hz, 1920x1200@60Hz,
HDMI Amplitude	T.M.D.S +/- 0.4Vpp
Differential impedance	100±15ohm
RS232/Ethernet control	
Baud rate and protocol	Baud rate : 9600, data bit : 8 , stop bit : 1,no parity checking
Ethernet	IE10.0+,HTML5
Power	
Max Consumption	100W, 110-240VAC
Matrix Mechanical dimensions	
Size(mm)	430(L)X300(W)X44 (H)
Weight	5Kg
Other	
Operating temperature	0 to 40°C
Storage temperature	-20 to 70°C
Permissible humidity	10%-50%

7. Package Contents

Item	Quantity
MXB88H unit	1
MXB88H User Manual	1
Bracket	0
AC Power Cord	1