

Contents

Chapter1 Safety Precautions	39
Chapter2 Item List	40
Chapter3 Hardware Connections.....	41
3-1 Rear View	41
3-2 Ports Description	41
3-3 Hardware Connection Diagram	42
3-4 Specifications	43
3-5 Product Dimensions	45
Chapter4 Front Panel Buttons Instructions	46
4-1 Front Panel Buttons Schematic	46
Chapter5 Configuration Modes and Function Instructions	49
5-1 AppM1 (Switcher)	50
5-2 AppM2 (2 mosaic)	51
5-3 AppM3 (3 mosaic)	52
5-4 AppM4 (4 mosaic)	53
5-5 AppM5 (4 Image)	54
5-6 AppM6 (3 Image)	55
Chapter6 Basic User Instructions.....	57
6-1 Signal Switching.....	57
6-2 Dual Picture Display Operation	59
6-3 Mosaic Function Operation	60
6-4 Multi-windows Display Operation	61
6-5 Other Basic Operation	63
Chapter7 Setup Menu Instructions	65
7-1 Output Port Config	66
7-2 Output Image Setting	67
7-3 Input Signal Setting.....	70
7-4 User Parameters Setting	71
7-5 Communication Setting	72
7-6 Language Setting	72
7-7 Advance Setting	73
7-8 Dual Pictures Setting (PIP)	74
Chapter8 Notes about models	75
Chapter9 Copyright information	76

Chapter 1 Safety precautions



Danger !

There is high voltage in the processor, to prevent any unexpected hazard, unless you are maintenance, please do not open the cover of the device.



Warning !

1. This device shall not encounter water sprinkle or splash, please do not place anything containing water on this device.
2. To prevent fire, keep this device far from any fire source.
3. If this device gives out any strange noise, smoke or smell, please immediately unplug the power cord from receptacle, and contact local dealer.
4. **Signal cables are not hot swappable.**



Caution !

1. Please thoroughly read this manual before using this device, and keep it well for future reference.
2. In the event of lighting or when you are not going to use the device for a long time, please pull the power plug out of receptacle.
3. Nobody other than professional technicians can operate the device, unless they have been appropriately trained or under guidance of technicians.
4. To prevent equipment damage or electric shock, please don't fill in anything in the vent of the device.
5. Do not place the device near any water source or anywhere damp.
6. Do not place the device near any radiator or anywhere under high temperature.
7. To prevent rupture or damage of power cords, please handle and keep them properly.
8. Please immediately unplug power cord and have the device repaired, when
 - 1) Liquid splashes to the device.
 - 2) The device is dropped down or cabinet is damaged.
 - 3) Obvious malpractice is found or performance degrades.

Chapter 2 Item list

Please unpack the product carefully, then check whether all the following things are included in the package. If anything is found missing, please contact the dealer.

Standard accessories

The accessories supplied with this LED Video Processor may differ from the figures contained in the User Manual, but they are applicable for the regions where you live (LED sending card is optional).

	
1.5m power cord x 1	1.5m DVI cable x 1
	
0.5m DVI cable x 4	1.5m RS232 / RJ45 adapter cable x 1
	
DVI-I to VGA adapter x 1	BNC-RCA adapter x 3
	
Disk x 1	User manual x 1

Chapter 3 Hardware Connections

3-1 Rear View

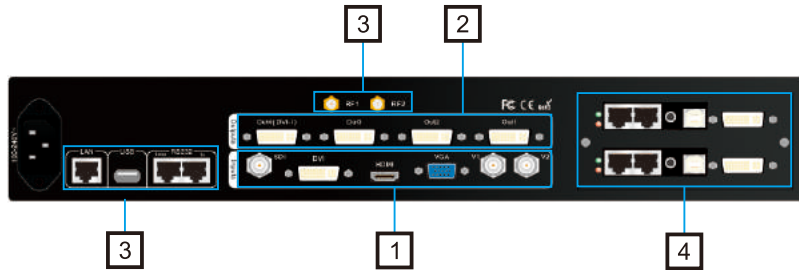

3-1 Rear Panel Signal Ports Diagram

3-2 Ports Description

1. Video Signal Inputs (Inputs)

LVP909 supports 6 video signals input as follows :

Ports	Description
V1、 V2	2 channels Composite video (PAL/ NTSC)
VGA	1 channels PC analog signal input
DVI	Channel DVI (PC digital signal)
HDMI	1 channel HDMI (HD digital signal)
SDI	1 channel SDI digital serial signal input

2. Video Signal Outputs (Outputs)

Ports	Description
Out1 ~ Out4	4 channels DVI output ports to connect LED sending cards or monitor. And Out 4 is DVI-I port including VGA output port.

3. Communication Ports

Ports	Description
LAN	TCP/IP local area network control interface
USB	USB communication port
RS232 IN	Serial communication interface, used to connect the RS232 port of PC to realize PC software control.
RS232 LOOP	Serial communication cascading output for connecting the RS232 IN of next unit, through single PC can control all units.
RF1、 RF2	Antenna interface of Wi-Fi control and image return function.

3-3 Hardware Connection Diagram

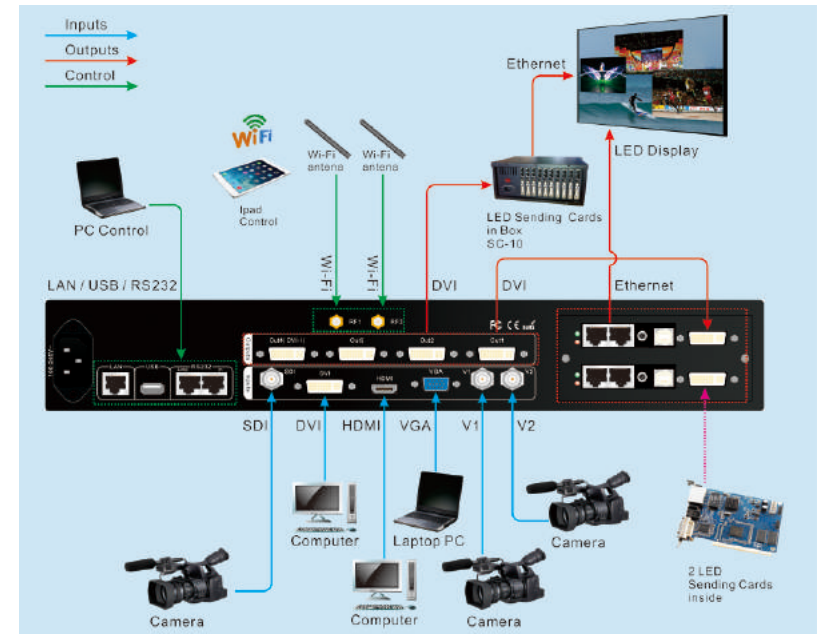

Pic 3-2 hardware connection diagram

3-4 Specifications

Inputs		
Number / type	2×Video 1×VGA (RGBHV) 1×DVI (VESA / CEA-861) 1×HDMI (VESA / CEA-861) 1×SDI	
Video system	PAL / NTSC	
Composite Video Amplitude Impedance	1V (p_p) / 75Ω	
VGA format	PC (VESA standard) ≤2048 x 1152_60Hz	
VGA Amplitude Impedance	R、G、B = 0.7 V (p_p) / 75Ω	
DVI format	PC (VESA standard)	≤1920×1200_60Hz
	HDMI 1.3 (CEA-861)	
HDMI format	PC (VESA standard)	≤1920 x 1200_60Hz
	HDMI 1.3 (CEA-861)	
SDI format	SMPTE 259M-C SMPTE 292M SMPTE 274M / 296M SMPTE 424M / 425M	480i_60Hz 576i_50Hz 720p、1080i、1080p
Input connectors	Video : BNC VGA : 15pin D_Sub(Female) DVI : 24+1 DVI_D SDI : BNC / 75Ω HDMI : HDMI port A type	
Outputs		
Number / type	4×DVI,1×VGA (RGBHV) (Out4)	
VGA / DVI format	1024×768_60Hz 1280×1024_60Hz 1440×1440_60Hz 1920×1080p_50Hz / 60Hz 1920×1200_60Hz	
Output connectors	DVI OUT : 24+5 DVI_I	

Others	
Control port	RS232 / USB / LAN / Wi-Fi
Input voltage	100~240VAC 50 / 60Hz
Power consumption	≤45W
Environment Temperature	0-45 °C
Environment Humidity	15-85%
Product size	483(L) x 274(W) x 66.6(H) mm
Packing size	520(L) x 350(W) x 130(H) mm
weight	G.W.: 5.9Kg, N.W.: 4.2Kg

3-5 Product Dimensions

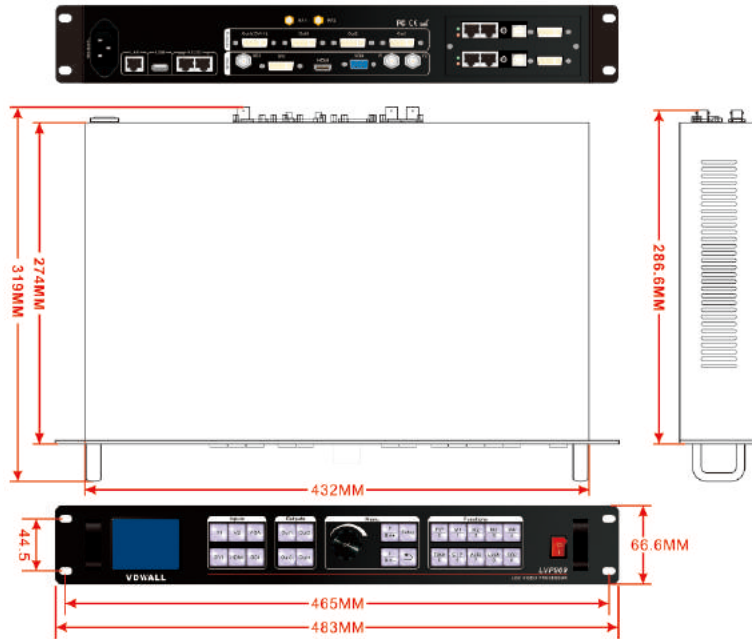

Pic 3-5a product dimension

Rs232 cable order:

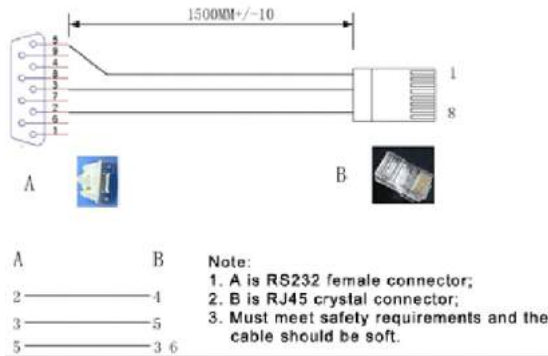

Pic 3-5b Rs232 cable order

Chapter 4 Front Panel Buttons Instructions

4-1 Front Panel Buttons Schematic

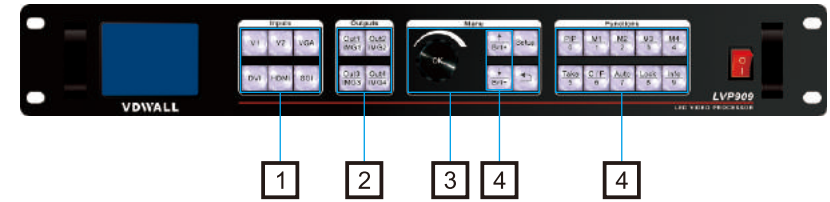

4-1 Front Panel Buttons Schematic

- ① Input signal selection buttons
- ② Output ports / image switching buttons
- ③ Setup buttons
- ④ Other function buttons

1. Input signal selection buttons

Input signal selection buttons are used for selecting input signals.



2. Output ports selection buttons

Output ports selection buttons are used for selecting output port under mosaic modes (APPM2, 3, 4).

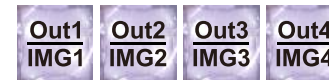

3. Image switching buttons

Under dual picture and multi-windows display modes, image switching buttons are used for selecting corresponding image or displaying the corresponding image on the top.

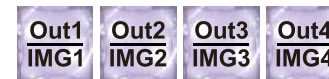

4. Setup buttons

Setup buttons: set the output image parameters.



Enter the setup menu



Select setup item



(**knob**) Rotate **Knob** to adjust parameters or select parameters.



(**OK**) Press **Knob** even **OK** button to save parameters.



Return to previous item.

5. VGA Auto Adjustment

VGA auto adjustment button (**Auto**): automatically adjust the VGA input signal.



6. Switching effect Selection Button (C / F)

Switching effect selection button (**C / F**): used to select the signals switching effect and time.



7. Take Switching Button

Take switching button (**Take**): under Pre. +Take switching mode, realize to switch from current signal to the pre-select signal.



8. Information Display Button

Information display (**Info**): display the processor current settings and information.



9. PIP Function Button

PIP: Turn on / off dual picture display under AppM1 mode. When the indicator is on, that means dual picture function is ready.



PIP mode buttons to set PIP modes or switch modes under PIP on state.

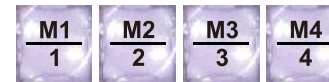

10. Brightness Adjustment Buttons (Brt+ , Brt-)

Brightness adjustment buttons (Brt+, Brt-): adjust processor output image brightness.

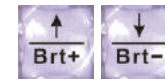

11. Display Mode Buttons

Display mode buttons (M1, M2, M3, M4): set display modes and call modes under mosaic and multi-windows application modes.

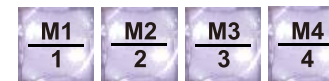

12. Lock Button (Lock)

Lock button(Lock): lock all buttons. When lock is on. The red light will be on all the time. In addition to the Lock button, the other buttons are not available. Press Lock button 3 times without stop to unlock, the red light is off.



Chapter 5 Configuration Modes and Function Instructions

LVP909 supports 6 channels video input signals including composite video, VGA, DVI, HDMI, SDI and other different signals. It has 4 channels DVI output and 1 channel VGA output (Out4). The maximum output format is 1920x1200_60Hz. According to different application, LVP909 has 6 different application modes(AppM) including AppM1(switcher), AppM2(2 mosaic), AppM3(3 mosaic), AppM4(4 mosaic), AppM5 (4 image), AppM6 (3 image).

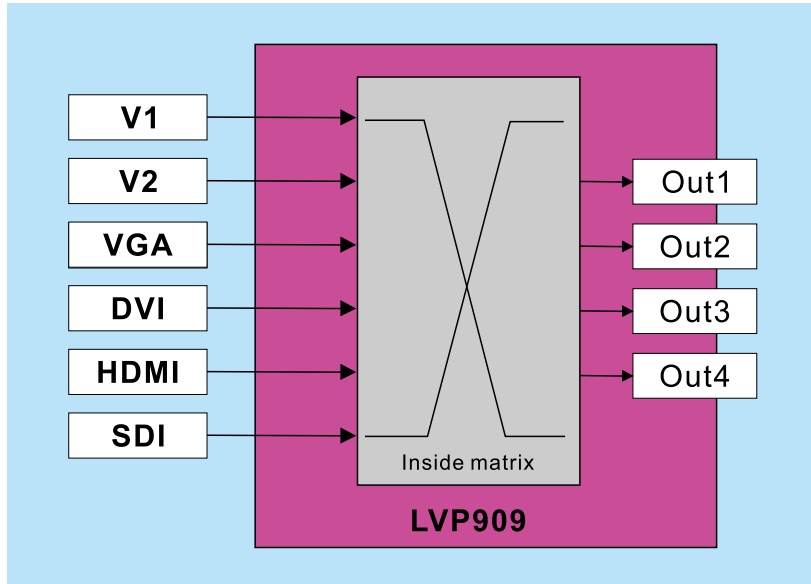

Pic 5 input and output sketch map

5-1 AppM1 (Switcher)

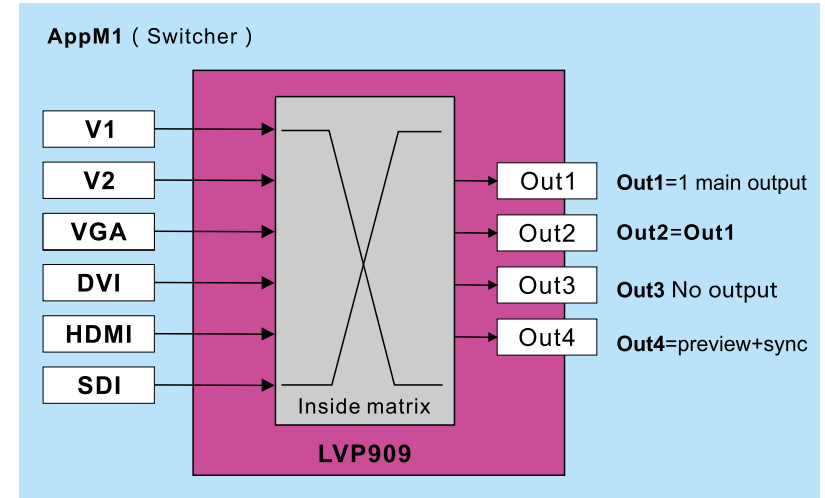

Pic 5-1a application mode 1 sketch map

Under this application mode, Out1=Out2=1main output, Out3 no output Out4=preview +sync monitoring, means:

Out1 and Out2 output the same image and display current signal.

Out4 in the form of left and right dual picture to display preview monitoring and sync monitoring respectively.

This application mode is also called switcher application. The main functions and features include:

1. Output the selected any input signal to Out 1 in seamless switching or fade in fade out or wipe switching way.
2. Realize **one key switch** and **Pre.+Take switch**
3. Display any dual picture in 4 different modes.
4. Out4output realize one single screen to display preview + sync monitoring.

AppM1 (Switcher) — Signal switching



Out1 and Out2 display the same image.

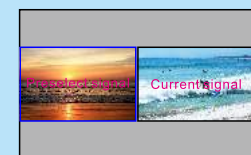

Out4 display image

Pic 5-1b application mode1 signal switching display image sketch map

AppM1 (Switcher)-Dual picture display

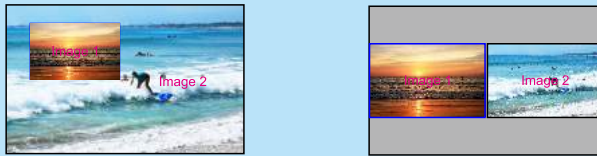

Out1 and Out2 display the same image Out4 display image

Pic 5-1c application mode 1 dual picture display output image sketch map

AppM2 (2 mosaic)



Out1 and Out2 used as mosaic Out4 display image

Pic 5-2b application mode 2 display image sketch map

5-2 AppM2 (2 mosaic)

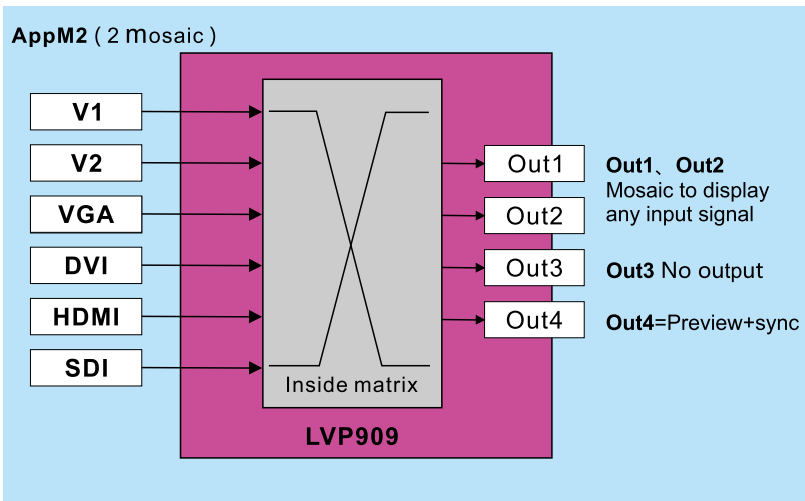

Pic 5-2a application mode 2 sketch map

Under this application mode, Out1=Out2=current input signal, Out4=preview +sync monitoring, means:

Out1 and Out2 display current signal and can be used for mosaic.
Out4 in the form of left and right dual picture to display.

This application mode is mainly used as mosaic of 2 output ports to realize seamless switching between input signals. Out4 display preview image and sync monitoring image.

5-3 AppM3 (3 mosaic)

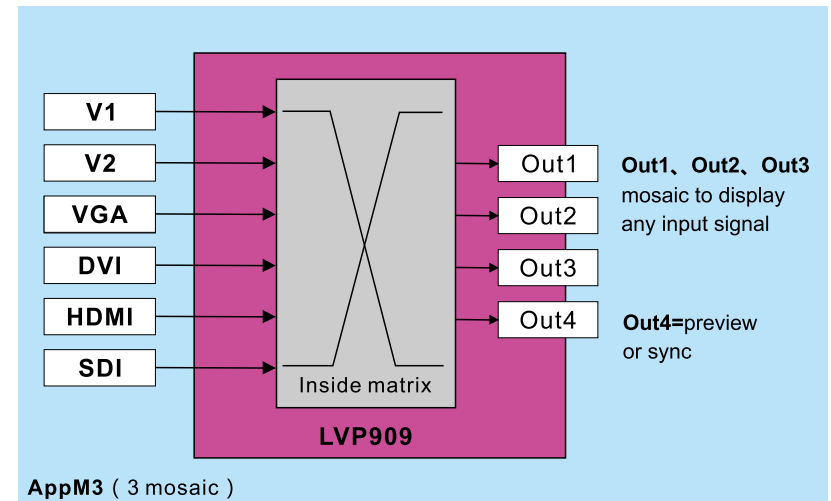

Pic 5-3a application mode 3 sketch map

Under this application mode , **Out1=Out2=Out3=** current signal, Out4=current signal or monitoring signal , means :

Out1 , Out2 and Out3 display current signal and can be used for mosaic.
Out4 display current signal or preselect signal.

This application mode is mainly used as mosaic for 3 output ports to realize seamless switching. Out4 display current signal under one key switch state and display preselect signal under Pre.+take switch state.

AppM3 (3 mosaic)



Out4 display image
 1. One key switch state: current signal
 2. Pre.+Take switch : preselect signal

Out1, Out2 and Out3 used as mosaic

Pic 5-3b application mode3 display image sketch map

AppM4 (4 mosaic)



Out1, Out2, Out3, Out4 used as mosaic

Pic 5-4b application mode4 display image sketch map

5-4 AppM4 (4 mosaic)

AppM4 (4 mosaic)

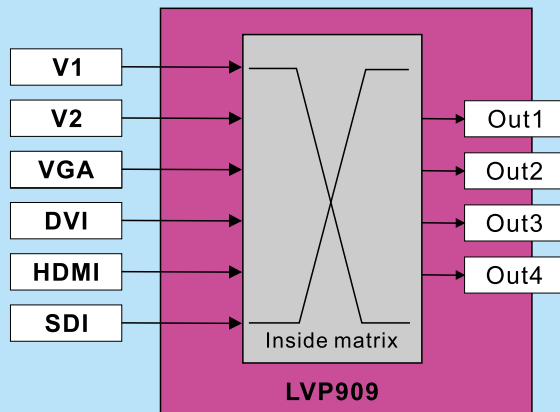

Out1, Out2, Out3 and Out4 mosaic to display any input signal

Pic 5-4a application mode 4 sketch map

Under this application mode , $Out1=Out2=Out3=Out4$ =current signal , means :
 Out1, Out2, Out3 and Out4 display any input signal and can be used for mosaic.

This application mode is mainly used as mosaic for 4 output ports to realize seamless switching between any input signals.

5-5 AppM5 (4 image)

AppM5 (4 image)

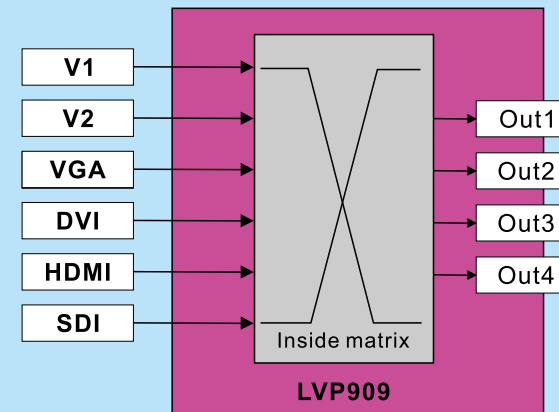

Out1= four images display
Out2=Out1
Out3 no output
Out4=Out1

Pic 5-5a application mode 5 sketch map

Under this application mode, $Out1=Out2$ = four images display, $Out4$ =sync monitoring means :

Out1, Out2 display the same four images assembled by any four input signals. Wherein Out1 and Out 2 output the same image. Out4 display sync monitoring image of four images.

This application mode is mainly used for mult-windows display. The maximum output is four images. Size, location and overlay order can be set four display modes and switch by mode buttons.

AppM5 (4 image)

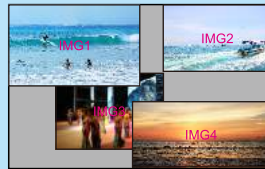

Out1, Out2 display the same image : any four images display
Out4 display output sync monitoring

Pic 5-5b application mode 5 display image sketch map

AppM6 (3 image)



Out1, Out2 display the same image : any three images display



Out4 display the same image : display three sync monitoring image in split-screen mode.

Pic 5-6b application mode 6 display image sketch map

5-6 AppM6 (3 image)

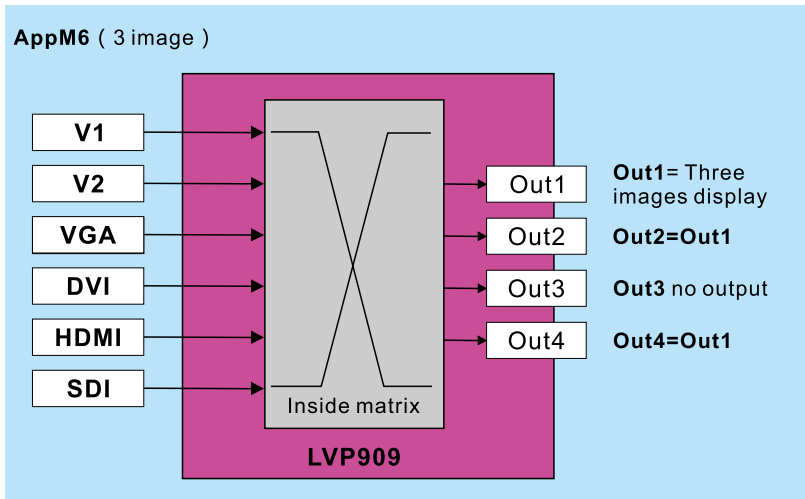

Pic 5-6a application mode 6 sketch map

Under this application mode, Out1=Out2=three images display, Out4=input sync monitoring , means :

Out1 and Out2 display the same any three images.

Out4 display three images monitoring in split-screen mode and switch through Out4 button.

This application mode is mainly used as three image display. Size, location and overlay order of three images can be set four display modes and switch through mode buttons. Comparing with AppM5, image 3 has higher resolution and display clear as background picture.

Chapter 6 Basic User Instructions

After the system is powered on, LVP909 will automatically detect the device information and enter the user operating status before the last shutdown. LVP909 has 6 application modes. And each mode can realize different functions. The operation is also different. Here we explain the basic user operation.

6-1 Signal Switching

In the application mode 1~4, that application under switcher and mosaic, LVP909 supports seamless switching between any two input signals. LVP909 supports two signal switching way including **one key switch** and **Pre.+Take switch** which can be set in user setup menu 3.1 switch mode. **One key switch is default switching mode.** Switch new signal through pressing input signals selection buttons. Pre.+Take switch adopts to press input signal buttons to preselect and then press **TAKE** button to switch from current input signal to preselect signal.

Input signal selection buttons as follow list:

Buttons	Description
V1、V2	2 * Composite video signal inputs (PAL/ NTSC)
VGA	1 * PC analog signal input
DVI	1 * DVI digital signal input
HDMI	1 * HDMI digital signal input
SDI	1 * SDI digital serial video signal input

1. Pre.+Take switch

In this switching mode LCD screen display as shown below, respectively, show the current and the pre-selected input signal source and their status. If there is no valid input signal input, it will display "no input". Meanwhile the corresponding input button is flicker slowly and LED screen is black. If there is effective signal, it will display the input format.

```

Curr. Input:      HDMI
Curr.In Status:  1080p_60Hz
Pre.Input:       V1
Pre.In Status:   PAL
-----
Out Posi.&Size:  ( 0 , 0 , 1920 , 1080 )
-----
Switch Mode:    Pre.+Take SW
Switch time:    0 Sec
App.Mode:       AppM1
  
```

Pic 6-1a LCD window: Preselect +Take switch

Switching signal way:

Press input buttons to preselect signal. LCD will display the preselect signal status after signal steady. Then press **Take** button to switch current output signal to preselect signal. After the completion of the switching, the preselect signal will be the current playing signal. In this switching mode, preselect signal lights: indicator flashes quickly with signal input. Indicator flash very slowly without signal input.

2. One key switch

In the one key switch status, LCD screen displays the following figure, LCD screen will display input signal and its status respectively.

```

input:           HDMI
In status:       1080p_60Hz
-----
Out Posi.& size: ( 0 , 0 , 1920 , 1080 )
-----
Switch mode:    One Key SW
Switch time:    5 sec
App. Mode:      AppM1
  
```

Pic 6-1b LCD window: one key switch

Switching signal way: press to select signal, the processor will auto finish the new signal preselection and switching process.

3. Switch effect selection (C / F)

Switch effect:	Cut

Cut	Fade
Slip: R->L	Slip : L->R
Slip: LU->RD	
Switch time:	0sec

1sec	2sec

Pic 6-1c LCD window: switch effect selection

This function is only available for non mosaic mode. Specific effects are as follow:

- In AppM1 signal switching state, press **C/F** button, the LCD will display the above menu and rotate **knob** to select **Cut**, **Fade** or **Slip** switching effect and switching time.
- In AppM1 PIP display mode and App5 and App6 multi-windows display modes, press **C/F** to switch **image overlay fade time** including 0 sec (**CUT**), 1 sec and 2 sec.

6-2 Dual Picture Display Operation

In AppM1 state, LVP909 can realize two pictures display. The two input signals can be any selection. And the position, size and overlay order can be preset four modes.

Image_1 source:	HDMI
Image_1 status:	1080p_60Hz
Image_2 source:	V1
Image_2 status:	PAL

Image_1 Posi.&Size:	(0, 0, 1920, 1080)
Image_2 Posi.&Size:	(64, 32, 640, 360)
Display Mode:	M2
App. Mode:	AppM1
Image2->1:	2 S

Pic 6-2a LCD window: dual picture operation

The specific operation methods are as follow:

Enter dual picture display mode: press **PIP** button and the indicator is on, lvp909 will enter dual picture display mode. Then press **Setup** button to enter setup menu to operate PIP(like the following figure).

D. PIP	AppM1 M3		

D.1 Image_1 source	V1	V2	VGA
	DVI	HDMI	SDI

D. 2 Image_2 source	V1	V2	VGA
	DVI	HDMI	SDI

D. 3 output image	>>		

Pic 6-2b LCD window: dual picture setting

Switch dual picture display mode: when dual picture mode is on, press mode buttons directly (**M1**、**M2**、**M3**、**M4**) to fast switch to corresponding display modes.

Change image source: when dual picture mode is on, enter setup menu **D.1 Image_1 source** or **D.2 Image_2 source** and rotate **knob** to select corresponding input signal and press **OK** to save.

Change image overlay order: when dual picture mode is on, press **IMG1** or **IMG2** button. And then the selected signal will display on the top.

Change image overlay order switching time: Press **C/F** to select Image overlay switching time including 0 sec (Cut), 1 sec and 2 sec.

Set output image: when dual picture mode is on, enter setup menu **D.3 output image**, press **↑** or **↓** to select corresponding setting and rotate **knob** to change parameters. Press **OK** to save.

6-3 Mosaic function operation

The AppM2, 3, 4 of LVP909 are mosaic mode. The corresponding output ports can splice together to drive huge LED screen. In the mosaic application modes, in addition to signal switching operation, users can call mosaic modes, check mosaic parameters and do other operation.

Input:	HDMI
In Status:	1080p_60Hz

OUT1 out posi.& size:	(0, 0, 1920, 1080)
OUT1 in posi.&size:	(0, 0, 1920, 1080)

Switch mode:	One Key SW.
App. Mode:	AppM4

Pic 6-3a LCD window: mosaic application mode

1. Call modes

In mosaic application mode, LVP909 can preset 4 groups mosaic parameters. Press mode buttons **M1**, **M2**, **M3**, **M4** to call corresponding modes directly.

2. Check parameters

In mosaic application mode, press output port buttons **Out1**, **Out2**, **Out3**, **Out4**. Then the LCD will display the current port output position and size.

3. Switch Out4 output monitor modes

In application mode3, Out4 output current signal or preselect signal monitor which is decided by the current signal switching way. Enter setup menu 3.1 switch mode to select signal switching way.

Switch mode	Out4 monitor output
One key switch	Current signal
Pre. +Take switch	Preselect signal

4. Set parameters

In mosaic application mode, press **Setup** to enter item 2.output image setup menu (the detail setting way please refer to page 67 -mosaic application mode output parameters setting)

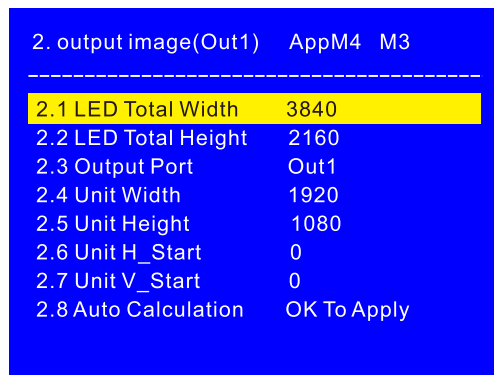

Pic 6-3b LCD window: mosaic parameters setting

6-4 Multi-windows display operation

The AppM5 and AppM6 are multi-windows modes. They will realize four images and three images display respectively. Users can preset 4 modes to display multi-windows position, size and overlay order. The following is the related operation.

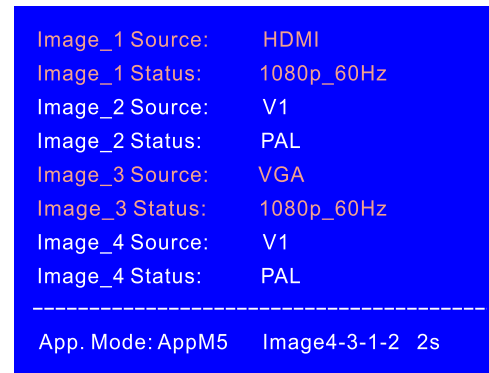

Pic 6-4a LCD window: multi-windows application mode

1. Switch image overlay order

Multi-windows display of LVP909 is realized through multi-windows overlay. The default overlay order is image 4/3/2/1 from top to bottom. The overlay relations can be switched through image buttons **IMG1**, **IMG2**, **IMG3**, **IMG4**: If you press corresponding image button **IMG1**, then image 1 is sticky.

2. Switch multi-windows display modes

Press mode buttons **M1**, **M2**, **M3**, **M4** to switch corresponding display mode.

3. Switch image input source

Press **Setup** to enter setup menu 3. Image Source, Press **↑** or **↓** to select corresponding image source and rotate **Knob** to select input signals. Press **OK** to save.

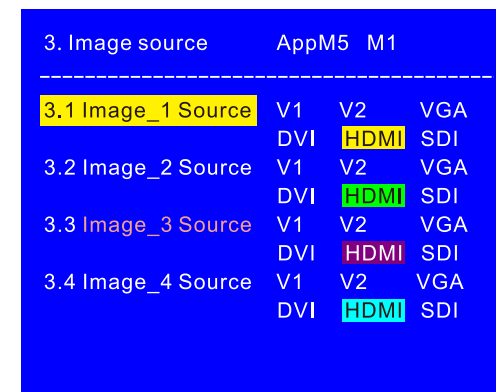

Pic 6-4b LCD window: multi-windows setting

4. Set output image position and size

Press **Setup** to enter setup menu, then press **↓** to select **2. Output Image** and press **OK** to enter. Press mode buttons **M1**, **M2**, **M3**, **M4** to select the desired adjustment display modes. Press **↑** or **↓** to select corresponding setting and rotate **knob** to change parameters. Press **OK** to save.

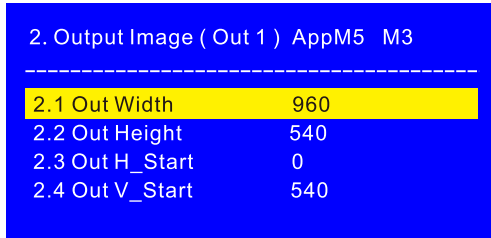

Pic 6-4c LCD window: multi-windows output image setting

5. Set output image border

LVP909 can set different color and size borders for each output image. Press Setup to enter **setup** menu. Then press **↓** to select **2. Output image** and press **OK** to enter. Press **↑** or **↓** to select corresponding setting and rotate **knob** to change parameters. Press **OK** to save.

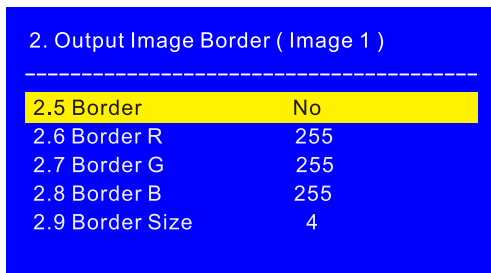

Pic 6-4d LCD window: multi-windows output image setting

6-5 Other basic operation

1. Output brightness selection

LVP909 can support 32 level brightness selection. To make sure of full gray scale of output image, it always set as 32.

Button	Description
BRT -	Reduce LVP909 output brightness, the lowest is 0.
BRT +	Increase LVP909 output brightness, the highest is 32.

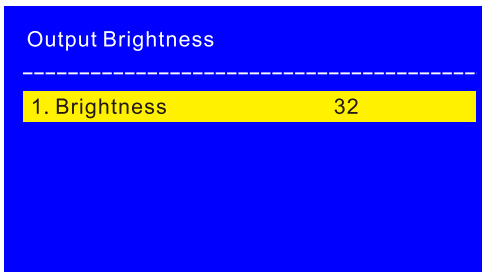

Pic 6-5a LCD window: output brightness setting

1. VGA input auto adjustment (Auto)

When LVP909 is in AppM1 and current input signal is VGA or Image 1 is VGA input in multi-windows mode, VGA input is effective. Press **Auto** to adjust VGA input signal sampling parameters. Then the VGA output image can be clear and full.

2. Button Lock (Lock)

Press Lock, then all buttons of LVP909 will be lock. In addition to Lock button, all other buttons are invalid to prevent misuse. Press 3 times Lock without stop to unlock. In the key locked, only LAN, Rs232, USB communication are available to prevent conflict between remote control and panel buttons. When remote control give commands, the device will enter buttons lock state auto. The menu will be as follow.

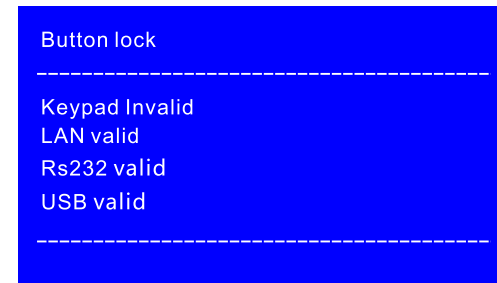

Pic 6-5b LCD window: button lock

3. Check system information (Info)

Press button **Info** to enter **System Info** menu. Press **↑**, **↓** to check. Press **↶** to exit. System info menu as follow:

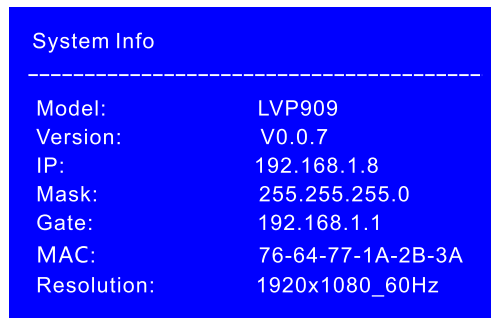

Pic 6-5c LCD window: system information



Pic 6-5d LCD window: system information

Chapter 7 Setup Menu Instructions

User setup menu is setting for the entire processor including 9 sections. They are output port configuration, output image setting, input signal setting, user parameters setting, communication setting, language setting, Audio setting, advance setting, dual pictures setting.

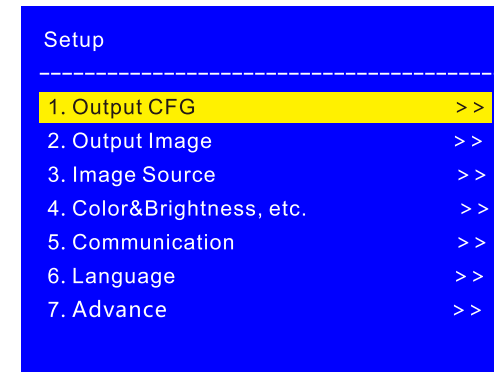

Pic 7 LCD window: Setup

After the system start, press **Setup** to enter user setup menu. Press **↑**, **↓** buttons to select corresponding setting items. Then press knob button (**OK** button) to enter and press **↶** to return back the previous menu. Here we will explain the detail functions of each menu.

7-1 Output port configuration

After the system start, press **Setup** to enter user setup menu. Press **↑**, **↓** button to select **1.Output CFG**. Then press knob button (**OK** button) to enter following figure **1.output CFG** menu. This menu is used to set output resolution and application mode of output ports.

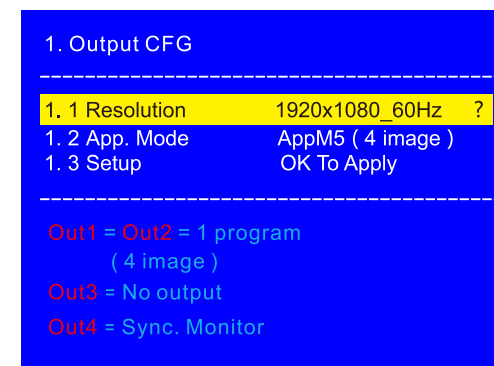

Pic 7-1a LCD window: output port config

Operation steps:

↑ or ↓ button to select desired adjustment menu and rotate **knob** to select suitable parameters. Then press ↓ button to select **1.3 setup** and press **OK**. The screen will display following confirmation menu. Press **OK** to restart the device. And the changed parameters are effective.

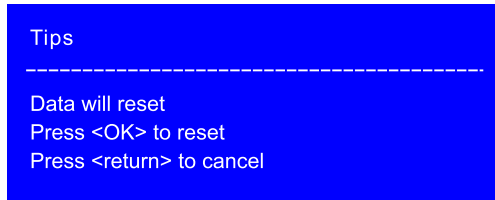

Pic 7-1b LCD window: initialization tips

1. Resolution

LVP909 outputs image from output ports. There are 6 fixed output resolution (refer to page 43 specification). Users can choose one not to be less than the LED screen resolution.

2. App. Mode

LVP909 has 6 application modes including AppM1 (switcher), AppM2 (2 mosaic), AppM3 (3 mosaic), AppM4 (4 mosaic), AppM5 (4 image), and AppM6 (3 image).

7-2 Output Image setting

Setup menu **2.output image** is used to set output image parameters of corresponding output ports. Different application modes, different setup menu. Here we will explain the entry way and setting method of different modes.

1. Output image parameters setting of AppM1

AppM1 is switcher mode. In this mode, output parameters menu is as follow. Press **Setup** to enter user setup menu and press ↓ button to select item **2.output image**. Then press **OK** to enter **2.output image** menu. The setting method is as follow:
↑ or ↓ button to select desired adjustment setting and rotate **knob** to select suitable parameters and press **OK** to save.

2. Output image (Out1) AppM1	

2.1 Out Width	1920
2.2 Out Height	1080
2.3 Out H_Start	0
2.4 Out V_Start	0
2.5 In Width	1920
2.6 In Height	1080
2.7 In H_Start	0
2.8 In V_Start	0

Pic 7-2a output image setting menu of App M1

2. Output image parameters setting of mosaic modes

Application mode 2, 3 and 4 are mosaic mode. Setimage mosaic parameters in output image setting menu. In this modes, press **Setup** to enter **2.output image** menu directly.

2. Output Image (Out1) AppM4 M3	

2.1 LED Total Width	3840
2.2 LED Total Height	2160
2.3 Output Port	Out1
2.4 Unit Width	1920
2.5 Unit Height	1080
2.6 Unit H_Start	0
2.7 Unit V_Start	0
2.8 Auto Calculation	OK To Apply

Pic 7-2b output image parameters setting of mosaic modes

	Adjustment items	Description
Auto Mosaic Menu	2.1 LED Total Width	Total screen width and height
	2.2 LED Total Height	
	2.4 Unit Width	Each port control LED screen size and position with respect to the entire screen.
	2.5 Unit Height	
	2.6 Unit H_Start	
	2.7 Unit V_Start	
	2.8 Auto Calculation	Calculate the mosaic parameters automatic.
Manual Setting Menu	2.9 In Width	Intercept DVI input image position and size.
	2.10 In Height	
	2.11 In H_Start	
	2.12 In V_Start	
	2.13 Out Width	Output parameters
	2.14 Out Height	
	2.15 Out H_Start	
	2.16 Out V_Start	

The setting method is as follow:

1. Press display mode buttons (**M1** , **M2** , **M3** , **M4**) to select desired setting mode.
2. Press output port buttons (**Out1** , **Out2** , **Out3** , **Out4**) to select desired adjustment output ports.
3. Set the total width and height of need mosaic LED screen in turn. And the port controls LED screen size and the position with respect to the entire LED screen. Then enter setup menu **2.8 Auto Calculation** and press **OK**. LVP909 will calculate the output and input parameters of this port.
4. From item 2.9~2.16, slight adjust the auto parameters according to the output image display effect.
5. Repeat steps (2~4) to set other ports parameters.

3. Output image parameters setting of multi-windows mode

Application mode 5 and 6 are multi-windows modes. Set each image output parameters in output image window. Press **Setup** to enter user setup menu and press **↓** to select **2.output image** and press rotate button (**OK**) to enter the following picture **2. output image** menu.

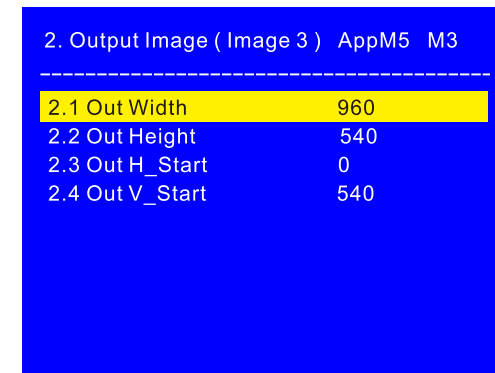

Pic 7-2C output image parameters setting of multi-windows mode

Setting method:

Press mode buttons (**M1** , **M2** , **M3** , **M4**) to select desired setting mode. Then press image selection button (**IMG1** , **IMG2** , **IMG3** , **IMG4**) to select desired setting image. Press **↑** or **↓** to select desired adjustment setting and rotate **knob** to select suitable parameters. And press **OK** button to save parameters.

7-3 Input video signal setting

Setup menu **3. Input Video Signal** is used to set processor input signal corresponding configuration. In switcher, mosaic and multi-windows mode, there are different setting.

1. Input signal switch mode

In switcher and mosaic mode(AppM1~4), this menu is used to set signal switching mode.

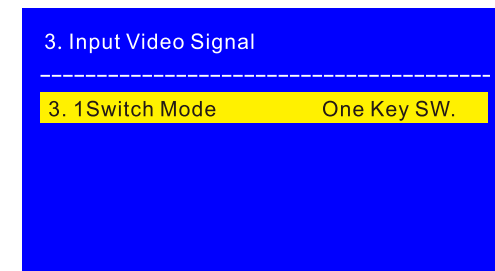

Pic 7-3a LCD window: Input signal switching mode

Setting method:

Enter setup menu **3.1 Switch mode** and rotate **knob** to select **One Key SW.** or **Pre.+Take SW.** Then press **OK** button to save parameters.

2. Image Source setting

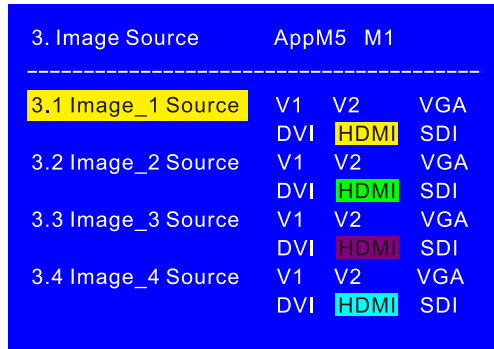

Pic 7-3b LCD window: image signal source setting

In multi-windows application mode (AppM5~6), this menu is used to switch image sources. Setting method:

Press **Setup** to enter menu **3. Image Source** and press display modes (**M1**, **M2**, **M3**, **M4**) to switch modes. Press **↑** or **↓** to select corresponding image source and rotate **knob** to select input signal. And press **OK** to save.

7-4 Color & Brightness etc. setting

LVP909 supports custom input image brightness, contrast and color setting.

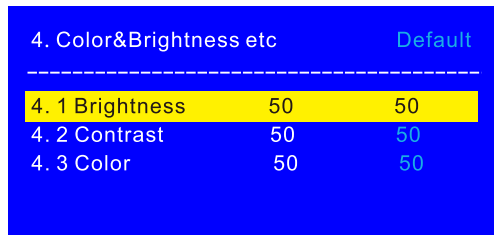

Pic 7-4 LCD window: image quality setting

Adjustment items	Description
4.1 Brightness	Range:0~100. Default value is 50
4.2 Contrast	Range:0~100. Default value is 50
4.3 Color	Range:0~100. Default value is 50

Notes:

1. To make sure of full gray scale of output image, they are always set as default value.
2. Color parameters are only available for V1、 V2、 SDI and Non -RGB format HDMI.

7-5 Communication setting

LVP909 can be remotely controlled via Ethernet. Communication setting menu is used to set network parameters including IP address, mask, gate, MAC and number the multiple LVP909 under the same IP.

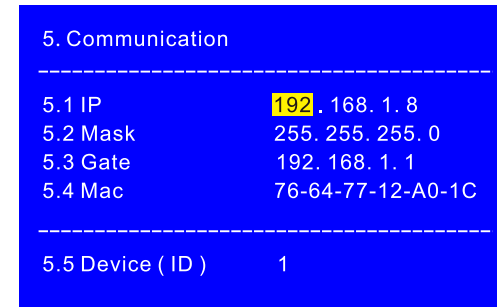

Pic 7-5 LCD window : communication setting

Setting method:

In **5. Communication**, press **↓** to find desired adjustment setting and rotate **knob** to select parameters. Finally press **OK** to save them. Then press **↶** button, the LCD will give tips to restart the system and follow it.

7-6 Language setting

LVP909 supports **Chinese** and **English** language. Rotate **Knob** to select one and press **OK** to save and effect.



Pic 7-6 LCD window : Language setting

7-7 Advance setting

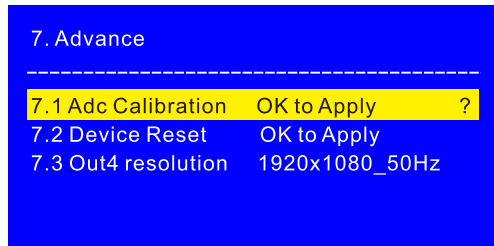

Pic 7-7a LCD window : Advance setting

1. ADC Calibration

“7.1 ADC Calibration” is used to calibrate the white balance of analog signals to avoid color cast or extreme darkness problem. This function is only available for V1,V2 and VGA ports. Setting method:

In the current available Analog signals, enter “7.1 ADC calibration” and press **OK** to start to calibrate.

Note: Processors finished white balance calibration before leaving factory. Please use this item carefully.

2. Device Reset

The menu is used to reset LVP909 back to current application mode and current output resolution default state. Setting method :

Enter **7.2 Device reset** , press **OK**. LCD will give reset tips and press **OK** to reset and restart the processor before it disappear.

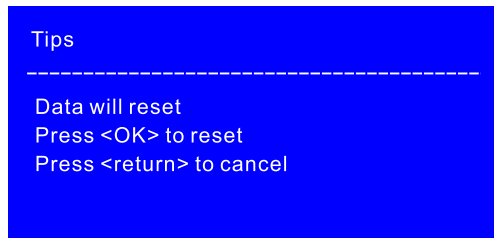

Pic 7-7b LCD window: initialization tips

3. Out4 resolution

Out4 output resolution defaults to be consistent with 1.1 Resolution. It also can be set as 1280x720_60Hz. The setup menu is **7.3 Out4 resolution** . Setting method :

Enter **7.3 Out4 resolution** and rotate **knob** to select output resolution and then press **OK** to save parameters.

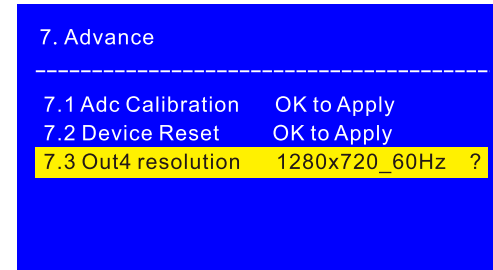

Pic 7-7c LCD window: Out4 resolution

Note: AppM4 need Out4 port to mosaic. It cannot set Out 4 resolution in this mode.

7-8 Dual picture setting (PIP)

In switcher mode (AppM1) and dual picture function is turned on(PIP indicator on) , press **Setup** to enter setup menu **D. PIP** . Users can set PIP signal and output image parameters.

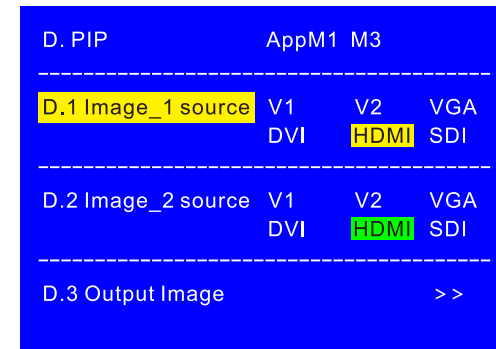

Pic 7-8a LCD window: PIP setting

1. Switch image source

D.1 Image_1 source and D.2 Image_2 source is used to switch image source. Setting method :

Enter setup menu D. PIP, press display mode buttons (**M1**, **M2**, **M3**, **M4**) to switch display modes. Then press **↑** or **↓** to select corresponding image source and rotate **knob** to select input signal and press **OK** to save.

2. PIP output image setting

D.3 Output image is used to set PIP output image parameters. Setting method: Enter setup menu D.3 Output image PIP, press display mode buttons (**M1**, **M2**, **M3**, **M4**) to switch display modes and press **↑** or **↓** to select corresponding output parameters. Rotate **knob** to adjust parameters and press **OK** to save.

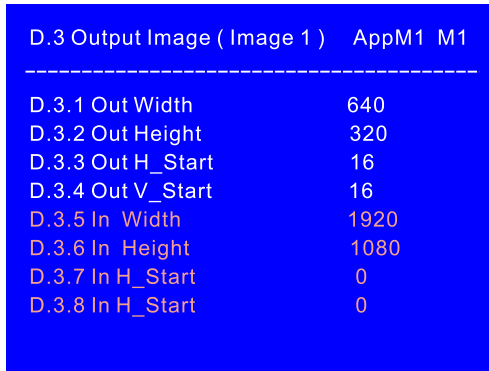

D.3 Output Image (Image 1) AppM1 M1	
D.3.1 Out Width	640
D.3.2 Out Height	320
D.3.3 Out H_Start	16
D.3.4 Out V_Start	16
D.3.5 In Width	1920
D.3.6 In Height	1080
D.3.7 In H_Start	0
D.3.8 In H_Start	0

Pic 7-8b LCD window: PIP output image setting

Chapter 8 Notes about models

LVP909: without Wi-Fi module
LVP909F: with Wi-Fi module

Chapter 9 Copyright Information

The copyright of this Manual is owned by SHENZHEN VDWALL CO., LTD., unless with prior consent of VDWALL, nobody is permitted to copy or use any part or all of the information contained herein.

This Manual is provided for reference only, VDWALL reserves right to change the product appearance, dimensions and specifications from time to time without notice to users.