

H.265/264 1080P HDMI Encoder

Operating Instruction



Thank you for purchasing this product. For optimum performance and safety, please read these instructions carefully before connecting, operating or adjusting this product. Please keep this manual for future reference.

SURGE PROTECTION DEVICE RECOMMENDED

This product contains sensitive electrical components that may be damaged by electrical spikes, surges, electric shock, lightning strikes, etc. Use of surge protection systems is highly recommended in order to protect and extend the life of your equipment.

Table of Contents

1. Package Contents.....	4
2. Specifications.....	4
3. Input Resolution List.....	4
3.1. VESA Resolution List.....	5
Encoder Mode:.....	6
1. Features.....	6
2. Wiring Diagram.....	6
3. Connecting.....	7
4. Device Setting Description.....	8
4.1. Change IP address from PC.....	8
4.2. Log in by browser.....	8
4.3. Status.....	9
4.4. Encoder.....	9
4.5. Main stream.....	9
4.6. Sub stream.....	10
4.7. Video Settings.....	10
4.8. Audio setting.....	10
4.9. OSD Setting.....	11
4.10. System Setting.....	12
MAINTENANCE.....	15
PRODUCT SERVICE.....	15
WARRANTY.....	15

1. Package Contents

- 1). 1x Encoder
- 2). 1x 12V/1A DC power supply
- 3). 2x Fixed Hangers
- 4). 1x Phoenix plugs for RS232 cable termination
- 5). 1x CD for control software & user manual

2. Specifications

Operating Temperature	0 to +40 °C (+23 to 149°F)
Operating Humidity	5 to 95%RH(No Condensation)
Max resolution	1080P60HZ-YUV444-8bit
HDCP Compliant	HDCP1.4
Audio Format Supported	Input: LPCM2.0 Sample rate 44.1KHz and 48KHz Audio Encode: AACLC, AAC+, AAC++ Audio bit rate: AACLC: 48~320 AAC+: 32~128 AAC++: 16~64
RS-232 serial port	3PIN terminal block connectors
Ethernet port (IP control)	RJ45, female
Default IP	192.168.1.168
Dimensions(WxHxD)	124*90*21mm
Net Weight	300g
Power consumption	DC12V1A 4W(Max)

3. Input Resolution List

Fresh Rate	I/P	Resolution	Support
50Hz (8BIT)	I	576i	√
	P	576P	√
	P	720P	√
	P	1080P	√
	I	1080i	√
60Hz /59.94Hz (8BIT)	I	480i	√
	P	480P	√
	P	720P	√
	P	1080P	√
30/29.97Hz	P	720P	√

(8BIT)	P	1080P	√
24Hz (8BIT)	P	720P	√
	P	1080P	√
25Hz (8BIT)	P	720P	√
	P	1080P	√

3.1. VESA Resolution List

Resolution	Support
800×600	√
1024×768	√
1280×768	√
1280×1024	√
1600×1200	√
1680×1050	√
1920×1080	√
1280×720	√
1360×768	√

Encoder Mode:

1. Features

- The output supports RTSP / HLS / RTMP (S) / RTP / UDP protocol
- Support a variety of video decoding: H.265 mainstream, H.264 basic, mainstream and advanced quality, MJPEG/JPEG basic quality
- Audio coding format supports AAC, AAC+, AAC++
- Maximum support 2 channel video stream decoding, support 1 channel only audio stream decoding
- Support HDCP1.4
- HDMI IN resolution supports the maximum 1080P60Hz 4:4:4 8 bit with one loop out
- Support CBR/VBR two coding modes, maximum code rate up to 40Mbps (Main code stream is 40M, Sub-code stream is 8M)
- Support analog audio extraction and analog audio embedded
- DC 12V 1A, the maximum power consumption can't over 4W

2. Wiring Diagram

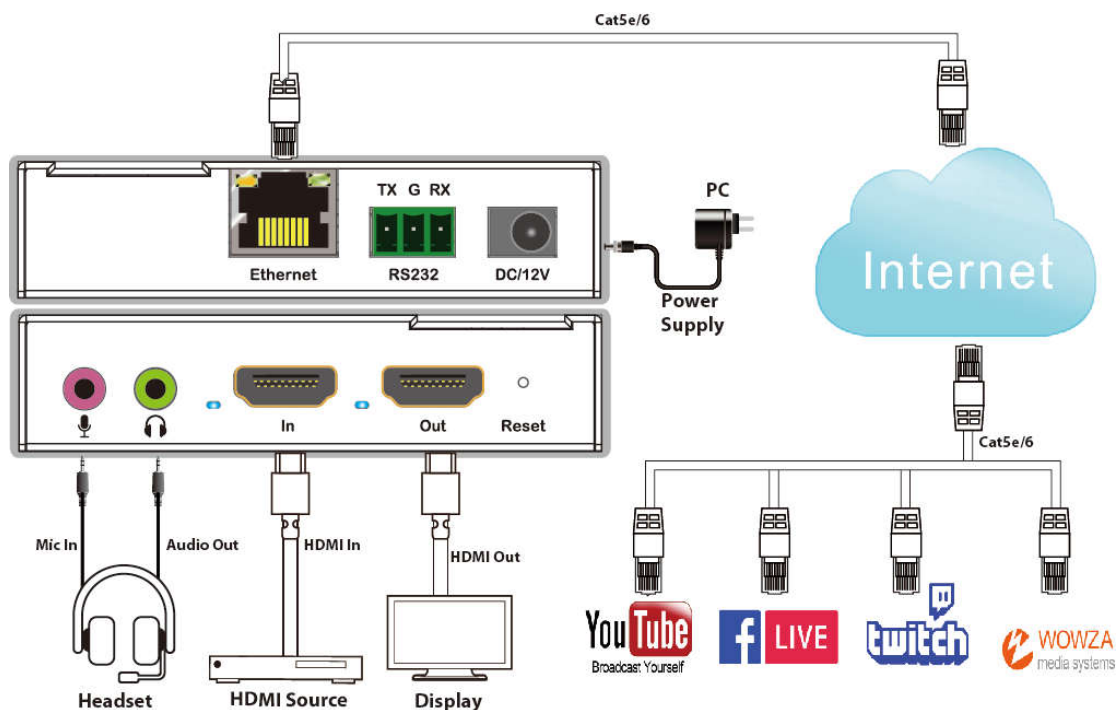

3. Connecting



- ① Audio Embedded port
- ② Analog Audio Extraction port
- ③ HDMI Input Indicator
- ④ HDMI Input port
- ⑤ HDMI Output Indicator
- ⑥ HDMI Output port
- ⑦ Reset button (Long press 3s to reset the unit)
- ⑧ DC12/1A Power input port
- ⑨ RS232 Port
- ⑩ Ethernet port

4. Device Setting Description

4.1. Change IP address from PC

Before configuring the device through the website, it is necessary to configure the IP address from the computer configured with the device (mainly to ensure that the computer and the device were set in the same network segment).

- 1). Open the network control center and set the computer's IP address
- 2). Choose to use Static IP, with the IP address set to 196.168.1.x (x ranges from 0 to 254, but cannot be consistent with the device's IP address: 192.168.1.168),
- 3). Subnet mask set to 255.255.255.0

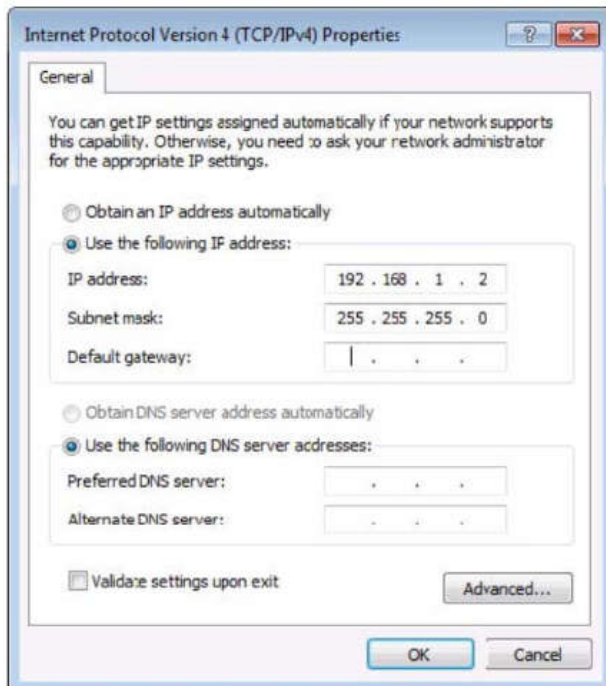

4.2. Log in by browser

Default IP address for log-in:192.168.1.168

Type in user name and password (default user name:admin; default password: admin)

Username

Password

Login

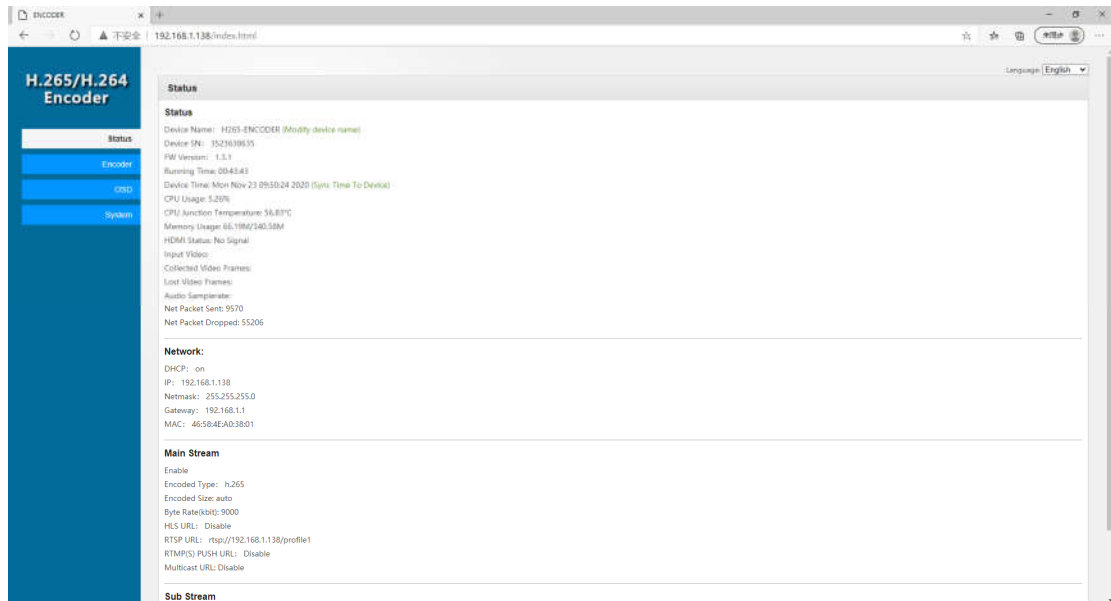

4.3. Status

Divided into five modes: "Status", "Network", "Main stream", "Sub stream" and "Audio stream"

4.4. Encoder

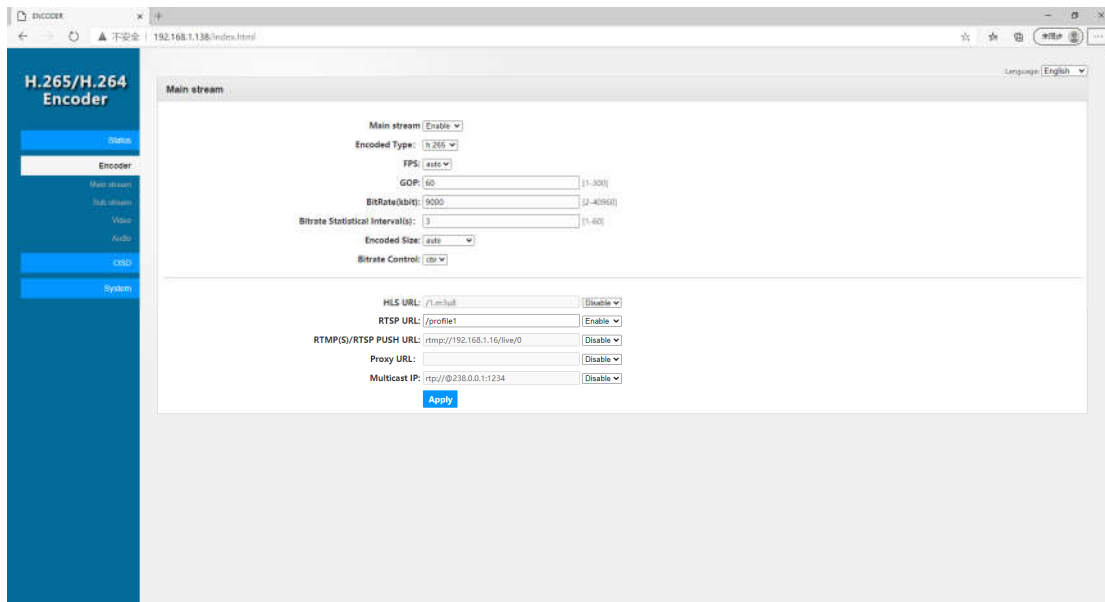

4.5. Main stream

1. Channel address can support RTSP / HLS / RTMP (S) / UDP / RTP protocol
2. The maximum support 1920*1080@60fps resolution decoding. Main stream default auto decoding
3. Bit rate (kbps) maximum support 2-40960, FPS maximum support 1-90, key frame interval maximum support 1-300, bit rate statistical interval (seconds)1-60, bitstream control: support CBR and VBR

4. Enable RTSP by default

- ※ No need to restart the device after successful setting
- ※ If all four frames are decoded at the same time, the source supports only 1080P encoded frame rate/key frame interval 25FPS video stream
- ※HLS format video streams only support H.264 decoding
- ※ RTMP needs to set the video encoding to H.264, and Youtube needs to set the audio format to AAC

4.6. Sub stream

1. The sub stream setting is the same as the main stream
2. The maximum bit rate of sub stream (KBPS) is 2-8192, and the maximum FPS is 1-30
3. After setting the sub stream, you can choose to set the Stream level, including baseline Profile, Main Profile and High Profile

4.7. Video Settings

1. Video input setting included: Rotation, Mirroring, Flipping, etc.
 2. Rotation include 90°, 180°, 270°
 3. Video source signal clipping can be used to clip images within the resolution range. Note that it will not take effect until it is started, and it is disabled by default;
- Note: The parameters for starting point-cut and cutting width in the upper left corner cannot exceed 1920. The parameters for starting point-cut and Height in the upper left corner cannot exceed 1080, and parameters can only be set to an even number.

4.8. Audio setting

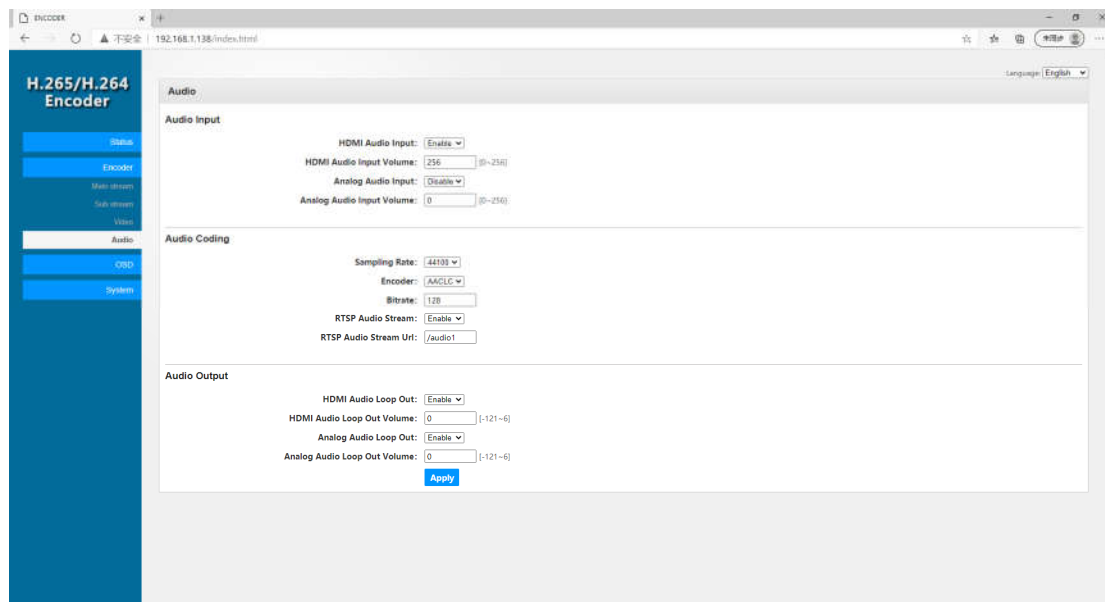

Audio Input

Audio input is using for HDMI audio input and Analog audio embedded settings, When the HDMI audio input and Analog audio input enabled at the same time, then the stream, such as the RTSP audio

will be played HDMI audio and the analog audio embedded simultaneously, Volume range 0 ~ 256;

※ Audio input is available for all streams

Audio Coding

Audio support AAC/AAC+ +/AC3/MP2/MP3, sampling rate 44.1/48khz, bit rate: 128 default

Support Enable RTSP Audio stream transfer or modify audio stream transfer address

※ Support to set sampling rate when HDMI audio input is enabled

Audio Output

Audio output support to set HDMI loop audio output and analog audio output

4.9. OSD Setting

Support setting 4 OSDs, supporting setting Format text, date, style, font size, color, etc. After setting, can be viewed in the main code stream and sub-code stream.

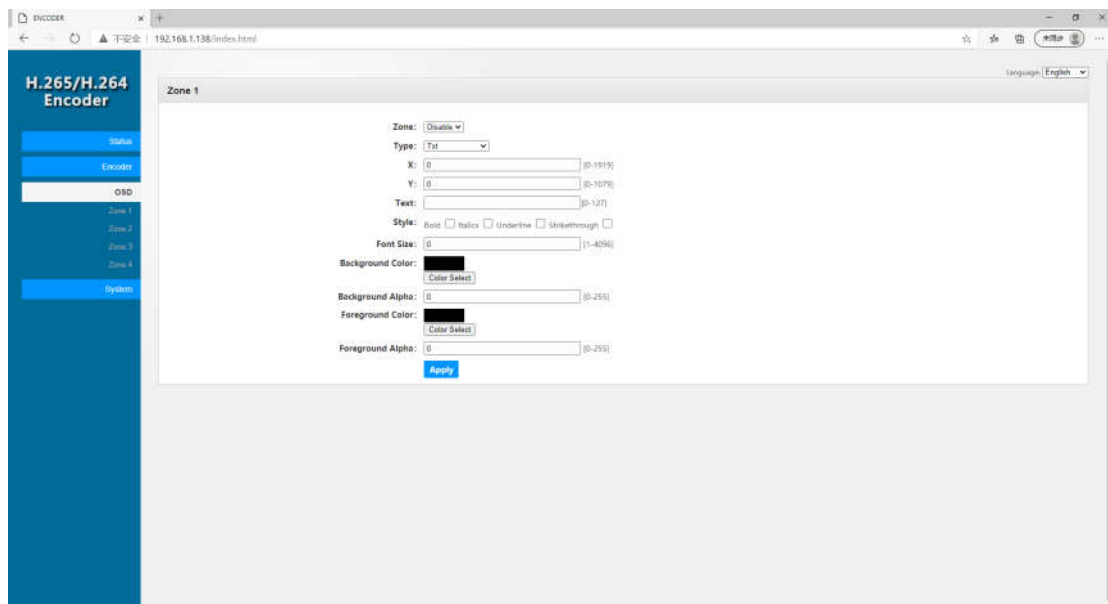

Note: Make sure the Foreground Alpha more than “1” when doing the OSD Setting. Setting the Foreground Alpha to “0” will make it impossible to see the font.

4.10. System Setting

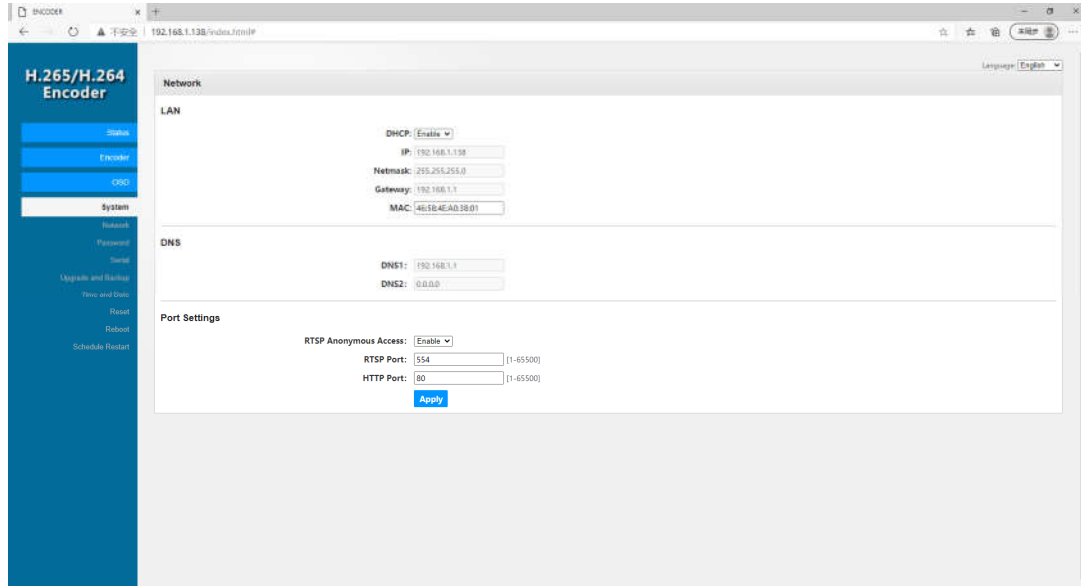

DHCP status: Enabled by default

IP: Only can be set when DHCP disabled. The factory default IP is 192.168.1.168

Net mask: The factory default net mask is 255.255.255.0

Mac address: factory fixed, support modification, restore after reset

Port Settings:

→RTSP anonymous Access: Enable means that no account and password need to be input when receiving video stream; otherwise, account and password needed.

The modified IP address cannot be the same as the IP address of all connected devices in the network

Password Setting:

Default account: admin

Password: admin

Password

Old password:

New password:

Confirm new password:

[Apply](#)

Serial port setting description:

RS232 Pass through support Encoder to Computer; Or Encoder to Encoder
 Testing method:

Encoder to Computer:

1. Using USB to RS232 cable access to the serial port of the Encoder
2. Open the serial port tool, connect to the correct port.
3. Enter the Encoder web page to set the port number, the web page can set the source port number and IP information; Target port number, target IP.
4. Checking the IP address of the computer, need to use a Network tool to type computer side information and device side information according to the following figure, and select the corresponding baud rate to perform RS232 Pass through between the computer and Encoder.

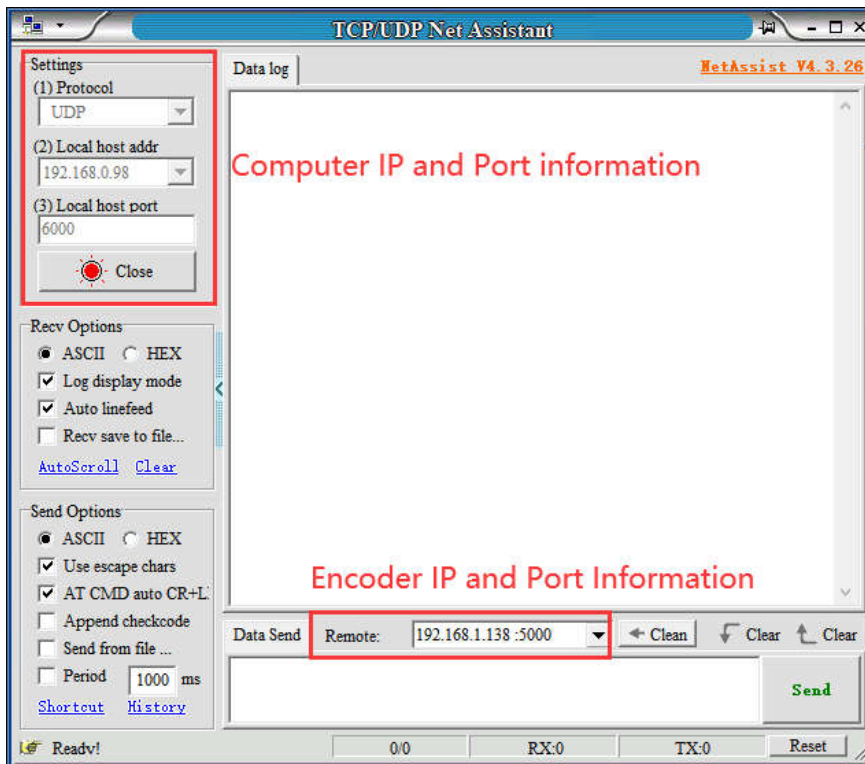

Encoder to Encoder:

Distinguishing between source and target information, type in correct Source IP, Port to the Source Encoder. Type in correct Target IP and Port to the target Encoder



Upload firmware and configuration and backup:

Upload firmware and configuration (Version:1.3.1)

Select File: 未选择任何文件 (Please don't upload by different people at the same time,don't power off during upload.)

Upload EDID

Select File: 未选择任何文件 (Please don't upload by different people at the same time,don't power off during upload.)

Backup Configuration

Time and date setting:

Time and date Settings

NTP sync:

Date Setting:

Time Setting:

Time Zone:

Factory reset:

Reset

Click the button to restore all the settings to the default.

Reboot:

Reboot

Click the button to restart the Device.

Schedule Restart:

Schedule Restart

Schedule Restart:

Repeat: Monday Tuesday Wednesday Thursday Friday Saturday Sunday

Schedule Time:

Language Setting:



The screenshot shows a web browser window with the URL 192.168.1.138/index.html. On the left is a sidebar with 'H.265/H.264 Encoder' and buttons for 'Status', 'Encoder', and 'OSD'. The main content area is titled 'Network' and shows 'LAN' settings: 'DHCP: Enable', 'IP: 192.168.1.138', and 'Netmask: 255.255.255.0'. A dropdown menu for 'Language' is visible in the top right corner, with 'English' selected and highlighted by a red box.

MAINTENANCE

Clean this unit with a soft, dry cloth. Never use alcohol, paint thinner or benzine to clean this unit.

PRODUCT SERVICE

(1) **Damage requiring service:**

The unit should be serviced by qualified service personnel if:

- (a) The DC power supply cord or AC adaptor has been damaged;
- (b) Objects or liquids have gotten into the unit;
- (c) The unit has been exposed to rain;
- (d) The unit does not operate normally or exhibits a marked change in performance;

The unit has been dropped or the cabinet damaged.

(2) **Servicing Personnel:** Do not attempt to service the unit beyond that described in these operating instructions. Refer all other servicing to authorized servicing personnel.

(3) **Replacement parts:** When parts need replacing ensure the servicer uses parts specified by the manufacturer or parts that have the same characteristics as the original parts. Unauthorized substitutes may result in fire, electric shock, or other Hazards.

(4) **Safety check:** After repairs or service, ask the servicer to perform safety checks to confirm that the unit is in proper working condition.

WARRANTY

If your product does not work properly because of a defect in materials or workmanship, our Company (referred to as "the warrantor") will, for the length of the period indicated as below, **(Parts(2)Year, Labor(90) Days)** which starts with the date of original purchase ("Limited Warranty period"), at its option either(a) repair your product with new or refurbished parts, or (b) replace it with a new or a refurbished product. The decision to repair or replace will be made by the warrantor.

During the "Labor" Limited Warranty period there will be no charge for labor.

During the "Parts" warranty period, there will be no charge for parts. You must mail-in your product during the warranty period. This Limited Warranty is extended only to the original purchaser and only covers product purchased as new. A purchase receipt or other proof of original purchase date is required for Limited Warranty service.

MAIL-IN SERVICE

When shipping the unit carefully pack and send it prepaid, adequately insured and preferably in the original carton. Include a letter detailing the complaint and provide a day time phone and/or email address where you can be reached.

LIMITED WARRANTY LIMITS AND EXCLUSIONS

1) This Limited Warranty ONLY COVERS failures due to defects in materials or workmanship, and DOES NOT COVER normal wear and tear or cosmetic damage.

The Limited Warranty ALSO DOES NOT COVER damages which occurred in shipment, or failures which are caused by products not supplied by warrantor, or failures which result from accidents, misuse, abuse, neglect, mishandling, misapplication, alteration, faulty installation, set-up adjustments, misadjustment of consumer controls, improper maintenance, power line surge, lightning damage, modification, or service by anyone other than a Factory

Service center or other Authorized Servicer, or damage that is attributable to acts of God.

2) THERE ARE NO EXPRESS WARRANTIES EXCEPT AS LISTED UNDER "LIMITED WARRANTY COVERAGE". THE WARRANTOR IS NOT LIABLE FOR INCIDENTAL OR CONSEQUENTIAL DAMAGES RESULTING FROM THE USE OF THIS PRODUCT, OR ARISING OUT OF ANY BREACH OF THIS WARRANTY. (As examples, this excludes damages for lost time, cost of having someone remove or re-install an installed unit if applicable, travel to and from the service, loss of or damage to media or images, data or other recorded content. The items listed are not exclusive, but are for illustration only.)

3) PARTS AND SERVICE, WHICH ARE NOT COVERED BY THIS LIMITED WARRANTY, ARE YOUR RESPONSIBILITY.