

# Introduction to Hardware of Z2000 PRO

## Device Interface

Zidoo Z2000 PRO is equipped with audio and video input & output ports and data transmission ports. Please refer to the descriptions in this manual.

### 1. Front

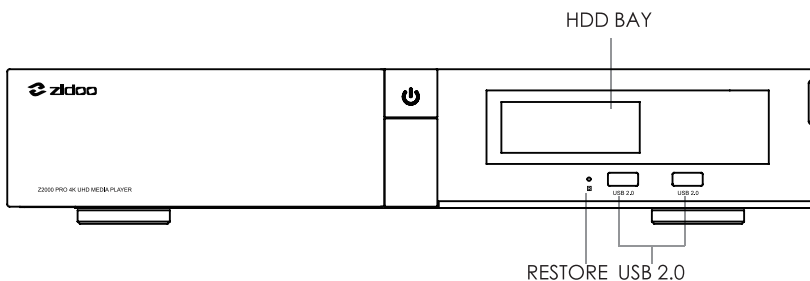
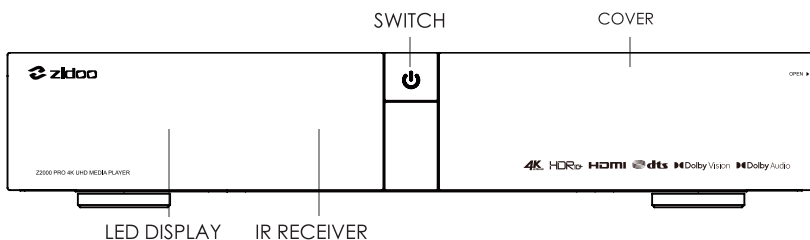

### 3. Right

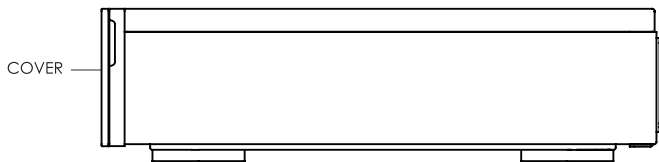

### 4. Back

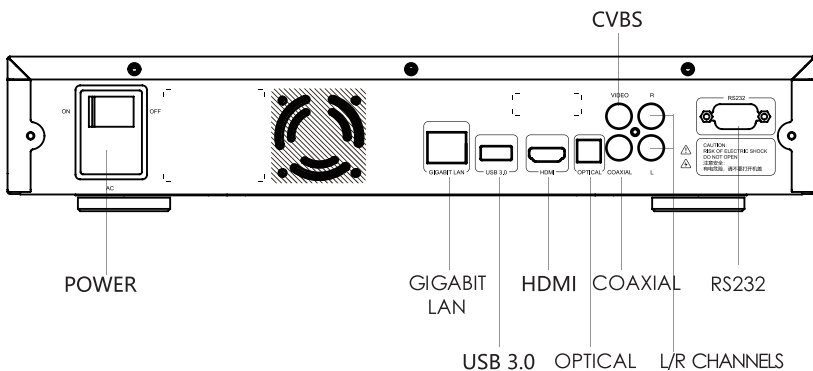

**Note:**

- \*Please load/change the hard disk after turning off the power. If it is a brand-new hard disk, Please load it after formatting it.
- \*Please prevent the orifice of the cooling fan from being blocked.
- \*Do not touch any liquid in case the liquid runs into the inner part of the device and damage it.
- \*Any maintenance personnel who are not appointed are not allowed to open the case.

## Load the Hard Disk

Z2000 PRO is equipped with 3.5 inches HDD Bay and high speed SATA transmission port. The hard disk can be loaded by pushing with hand. (The maximum hard disk supports 14 TB )

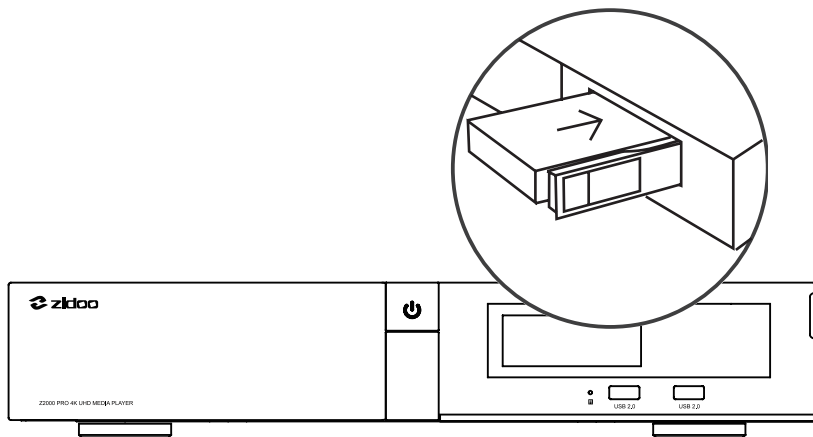

**Note:** Do not load or change the hard disk while the power is on to avoid damage of the device or hard drive data. If it is a brand-new hard disk, please format it before loading it to the device. This device supports hard disk of the following formats: EXT3, EXT4, NTFS, FAT32, EXFAT.

# Device Connection

## 1. Connect HDMI Cable to TV

1) Cut off the power. Please make sure the power of the TV and media player are off.



2) When the TV is turned off, please connect HDMI port on Zidoo to HDMI IN port on TV.



HDMI

3) Connect with the power. This device is equipped with suitable AC power adapter. Please connect the head of AC power adapter to the AC power input port of this device, then insert the plug of AC power adapter into the socket of 110V -240V.

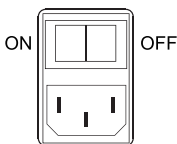

4) Press the power button on the front panel of the device or press the power button on remote control to turn it on. And then turn on the TV.

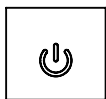

5) Corresponding video source is selected on TV.

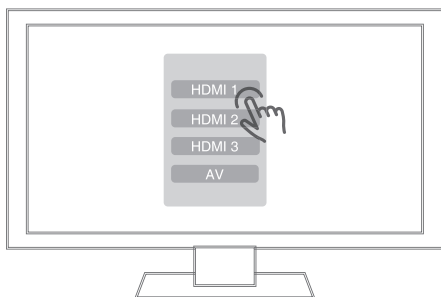

### **2. Connect AV Cable to TV**

The connection method is same as connecting HDMI cable.

## Z2000 PRO Specification

<b>Front Display</b>	LED
<b>Shell</b>	Aluminum Alloy
<b>OS</b>	Android 11
<b>CPU</b>	Realtek RTD1619BPD ARM Cortex-A55(Quad-core)
<b>GPU</b>	ARM Mali-G57
<b>NPU</b>	1.6TOPS
<b>RAM</b>	4GB DDR4
<b>Internal Storage</b>	32GB eMMC
<b>Bluetooth</b>	BT 5.2
<b>WIFI</b>	2.4G + 5G dual-band WiFi, 802.11 a/b/g/n/ac/ax 2T2R, 802.11ax MIMO OFDM
<b>Ethernet</b>	1*RJ-45 Ethernet Jack (10/100/1000Mbps)
<b>HDMI Out</b>	HDMI 2.1, support up to 4K @ 60p, HDR, 12Bit, YCbCr 4:4:4 color range, support audio pass-through
<b>Video Decoding</b>	4K@60p,AV1/HEVC/H.265,12Bit, HDR10, HDR10+, Dolby vision
<b>Audio Decoding</b>	Support high-definition audio pass-through and audio decode
<b>Intelligent Control</b>	Mobile APP control, RS-232, TCP/IP control and WOL support
<b>SATA</b>	1*HDD Bay
<b>USB</b>	1*USB 3.0, 2*USB 2.0
<b>Power Supply</b>	100-240V~,50/60Hz,Max 0.25A
<b>Other interface</b>	1*IR Receiver, 1*RCA Cvbs, 1*RCA Audio L/R Channels, 1*Coaxial/1*SPDIF(2CH, 5.1CH), 1*RS-232

# Boot Initialization Wizard

Before using the machine formally, the system will perform the initial setup. Please set according to devices and requirements to get the best visual experience.

## 1. System language selection, screen zoom, time zone setting

Choose the system language according to your language habit.

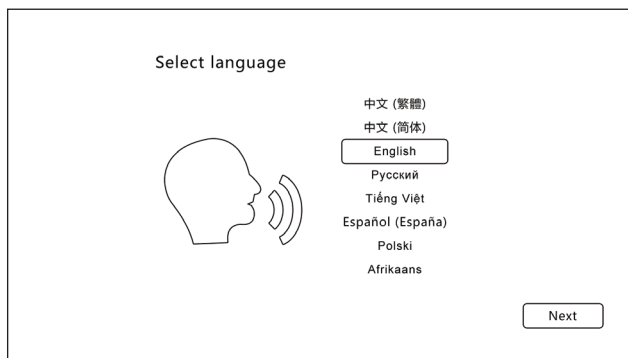

Press the UP and DOWN buttons on remote control to adjust screen display area.

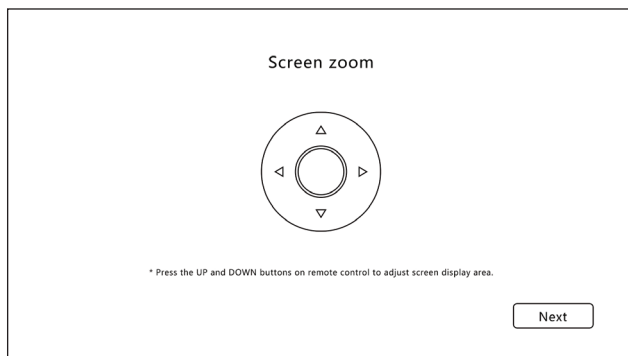

Select the time zone for the system according to your location.

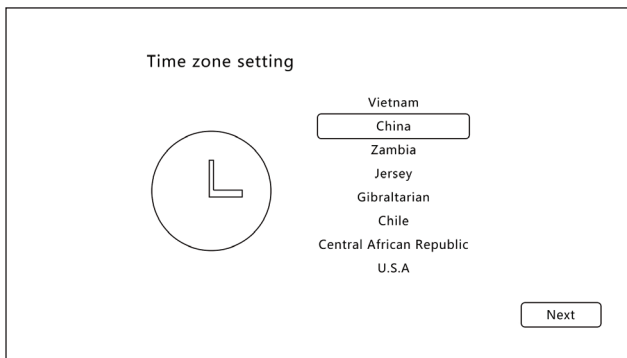

## 2. Bluetooth Match-Up

Let remote controller be aligned with media player and press Page-Down KEY and Menu KEY at the same time for least 5 second until indicator light blinking. The light will be off after matching successfully.

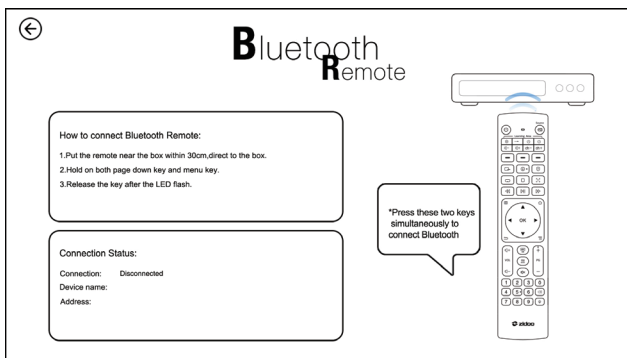



## 3. Network Setting

Configure network to connect device with network quickly.

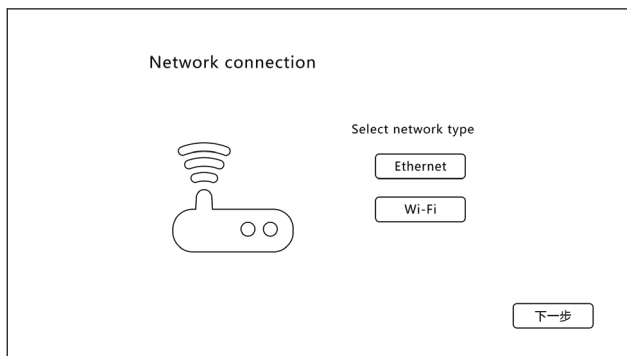

**WIFI:** choose network SSID, input password and connect WIFI.

**Ethernet:** plug in the network cable to connect the network automatically .

## 4. Select output mode

Please select the corresponding mode according to your needs, then it will finish relevant setting.

**Wizard mode:** select the corresponding option according to your usage environment and device connection.

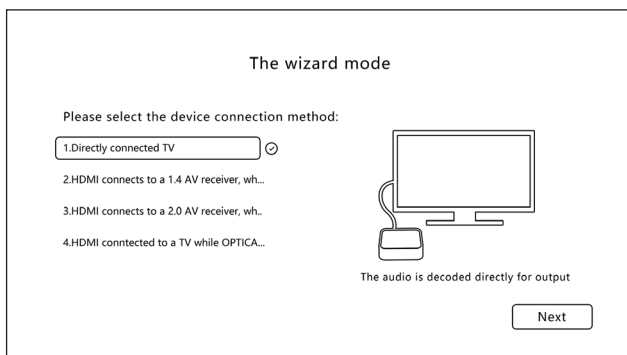

**Expert mode:** The audio and video output is customized by users, it is recommended for professionals.

### Expert

Resolution	HDR mode Auto <small>According to the content of the display and the ability of the di...</small>
HDR mode	HDR mode <small>All content will be mapped to HDR10 output, up to HDR10+</small>
Video frame rate	SDR Rec.709 Limited <small>All content will be converted to SDR Rec.709 output</small>
Audio output	Dolby Vision V510 Engine (Output HDR) <small>In this option, HDR content is processed using the Dolby Vision...</small>
	Dolby Vision V510 Engine (Output SDR) <small>In this option, HDR content is processed using the Dolby Vision...</small>

Next

## 5. The key definition

Define the corresponding functions for number keys, timing key, subtitle key, audio key, up and down keys and page keys on the remote control according to your usage habits.

### The key definition

Number keys	Specific percentage of video >
Timing keys	Close >
Subtitle keys	Subtitle list >
Audio keys	Audio list >
Up and Down keys	Switch chapter >
Page Turning Keys	Switch chapter >

Next

After completing settings above, please follow prompts and click “Next” to finish initial setup. Enjoy Zidoo audio visual feast!

# OTA System Update

Zidoo will update the firmware from time to time. Find the update icon in APPs and click it, online update and local update are supported. After ticking "Automatically check online upgrade", you will receive the prompt for the latest firmware update automatically.



## 1. Online Update

Click "Online Update" to obtain information of online update.

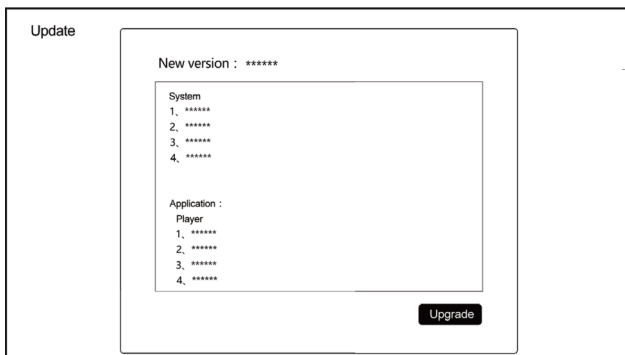

## 2. Local Update

Users can download the update files on the forum or official website and update firmware through files.

Copy the downloaded update file to USB disk. Click "USB update" to select the update file.

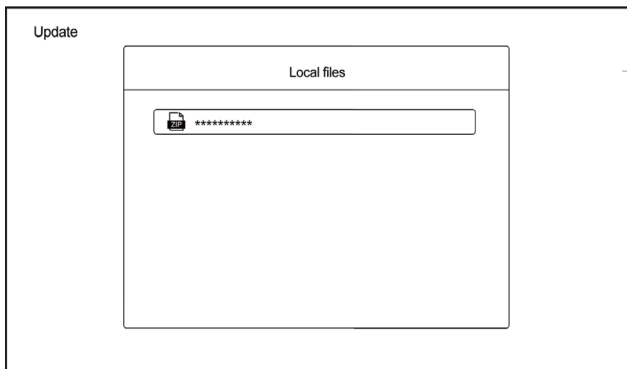

Download the update file by online update or local update. Click "Update" to update it.

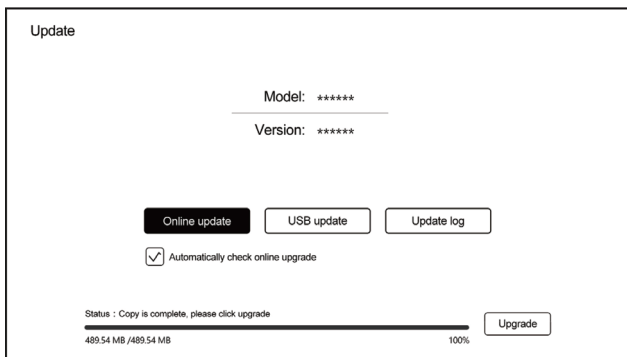

The system will automatically check the update file whether is completed or not.

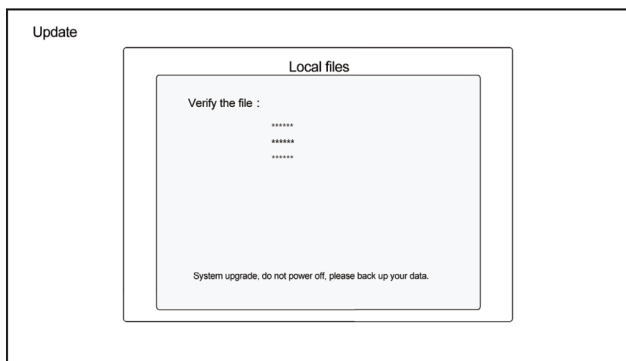

**Note:** Automatically access to system upgrade. Please don't power off in the progress.

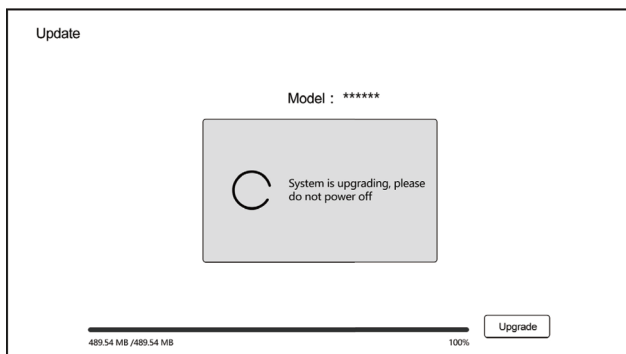

Once the update process is completed, the system will automatically restart.



### **Special Note:**

To guarantee user experience, Zidoo will update the firmware from time to time. Therefore, this manual may not be totally in line with the product.