

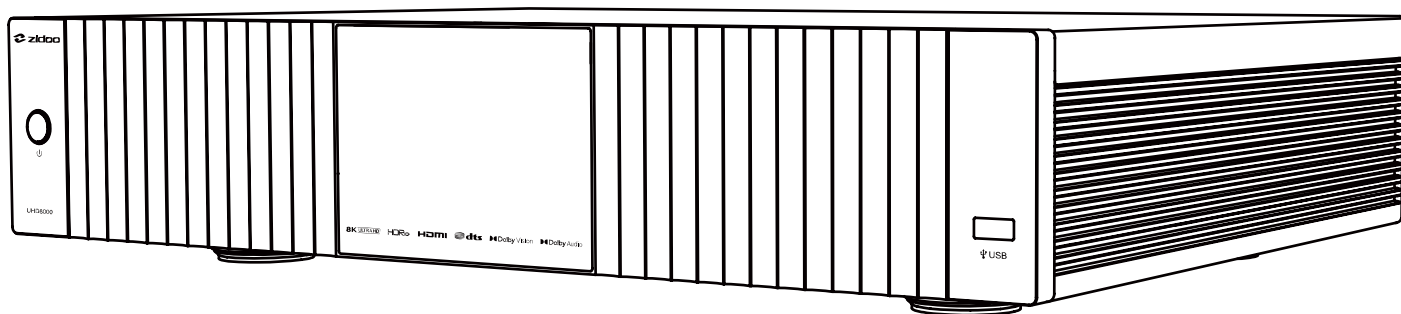

***UHD* 8000**

PRODUCT **MANUAL**

产品说明手册



INTRODUCTION TO HARDWARE

Interfaces

The ZIDOO UHD8000 is equipped with a wide range of audio and video input/output interfaces and data transfer ports.

1.Front

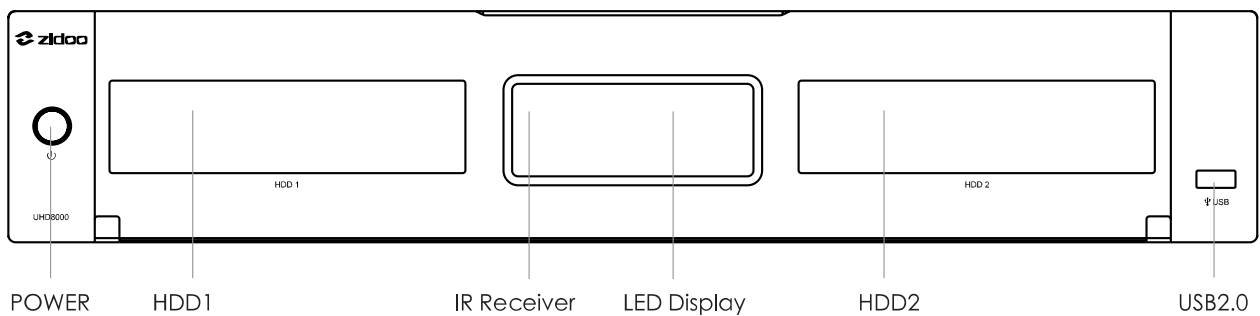

2.Back

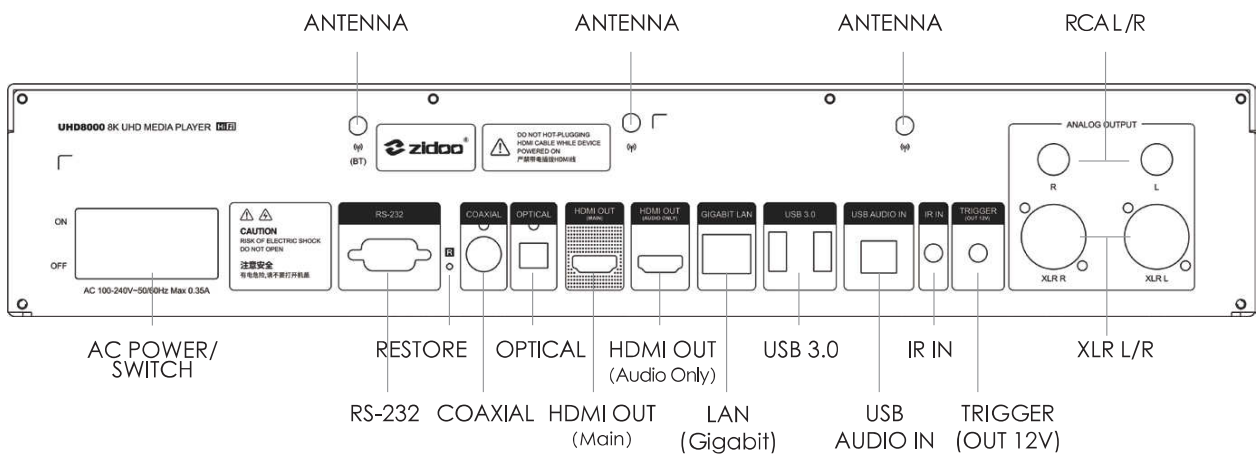

Antenna Installation Instruction: Please install the three antennas from the accessories onto the antenna interfaces shown in the image above.

Notes:

- * Please install/replace the hard disk when the power is off. If it is a brand new hard disk, please format it before installing.
- * Do not cover any ventilation holes with any objects.
- * Avoid contact with liquids to prevent damage to the internal components.
- * Do not open the casing unless you are an authorized repair personnel.

Specifications

Chassis Material	Aluminum alloy
OS	Android 11
CPU	Amlogic S928X-K ARM Cortex-A76+Cortex-A55 (Quad-core)
GPU	ARM Mali-G57 MC2
Storage	8GB DDR4 + 64GB eMMC
Bluetooth	BT 5.2
Wi-Fi 6	2.4G+5G dual-band Wi-Fi, 802.11 a/b/g/n/ac/ax 2T2R, 802.11ax MIMO OFDM
Ethernet	RJ-45 Ethernet jack*1 (10/100 /1000Mbps)
HDMI Output (Main)	HDMI 2.1a, supports up to 8K@60p, HDR10+, 12Bit color depth, BT2020 wide color range; Supports HDR10, HDR10+, HLG, Dolby Vision; Supports Dolby Atmos and DTS X audio pass-through
HDMI Output (Audio Only)	HDMI separate audio and video output, supports Dolby Atmos and DTS X audio pass-through, as well as multi-channel PCM and DSD output
Video Decoding	8K@60p AV1/VP9/H.265/AVS3/AVS2; HDR10, HDR10+, HLG, Dolby Vision
Audio Decoding	Supports Dolby/DTS format (up to Dolby TrueHD Atmos and DTS X) decoding, equipped with XMOS+ESS9069Q, supports up to PCM 768kHz@32Bit, DSD 512 decoding
Streaming	Supports DLNA/Squeeze lite/TIDAL connect streaming (supports TIDAL Connect ATMOS streaming) Integrates a wide range of music streaming services
USB Audio Input	Supports Windows 10/11, Mac system, Android system, supports up to 2-channel DSD512, PCM 768KHz@32bit PCM decoding
Audio Output	USB output, Optical output*1, Coaxial output*1, RCA L/R channel output*1, XLR L/R channel balanced output*1
Analog Audio Characteristics	Frequency range: 20Hz-20KHz +/-0.15dB; SNR: >123dB THD+N:< 0.00015%; Output level: (XLR) 4.2Vrms. (RCA) 2.1Vrms.; DNR:>123dB; Crosstalk: 135dB
Intelligent Control	APP control for iPhone,iPad landscape mode,Android phone,Android tablet landscape mode, RS-232, TCP/IP control (supports WOL)
SATA	Two built-in 3.5" HDD bays with SATA 3.0 specification (HDDs not included)
USB	USB 3.0*2, USB 2.0*1
Power Supply	AC 110~120/220~240V 50/60Hz
Other Interfaces	Infrared receiver*1, RS232*1 , Trigger Out 3.5 headphone jack*1, IR IN 3.5 headphone jack*1, antennas*3

Hard Disk Installation

The UHD8000 has dual 3.5-inch HDD bays with built-in high-speed SATA transfer interfaces. Please slowly push the hard disk with SATA interface facing inward to install, no tools are needed (the maximum supported hard disk capacity is 16TB).

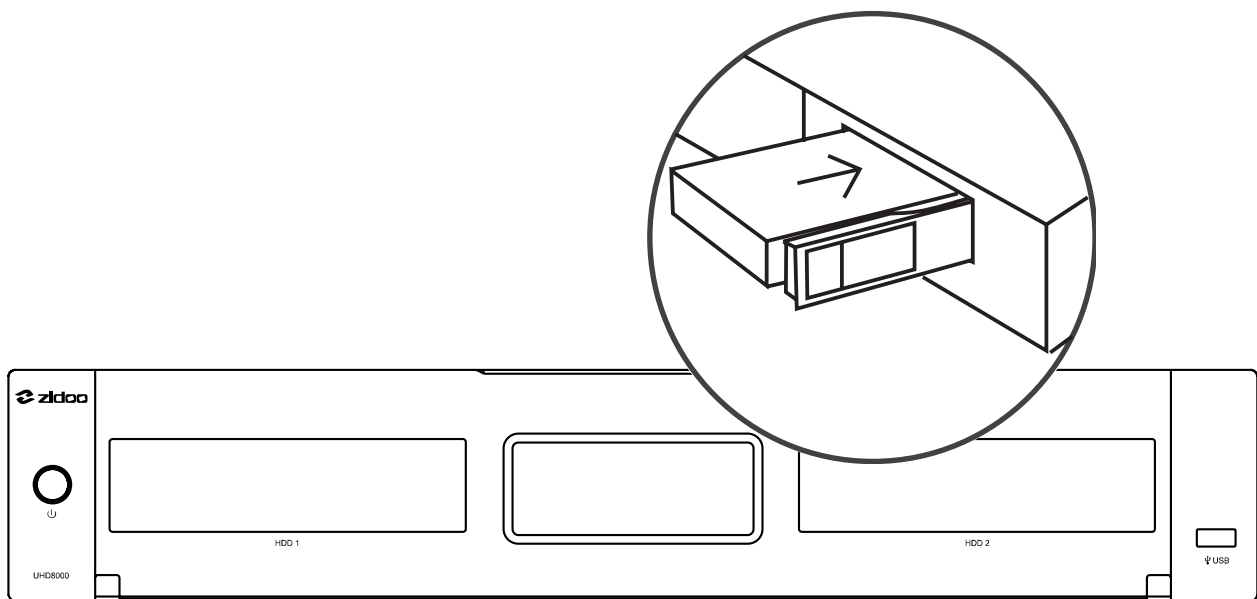

Note: Do not load or replace the hard disk while the device is powered on to avoid damage to the device or hard disk data. Brand new hard disks need to be formatted before loading. This device supports the following hard drive formats: EXT3, EXT4, NTFS, FAT32, EXFAT.

Example Connection

1. HDMI Connects to TV

The UHD8000 has two HDMI connection methods: HDMI single-port output and HDMI dual-port output. Please refer to the following steps for connection.

- ① Cut off the power of the devices. Please make sure the power of both the TV and this media player are off.

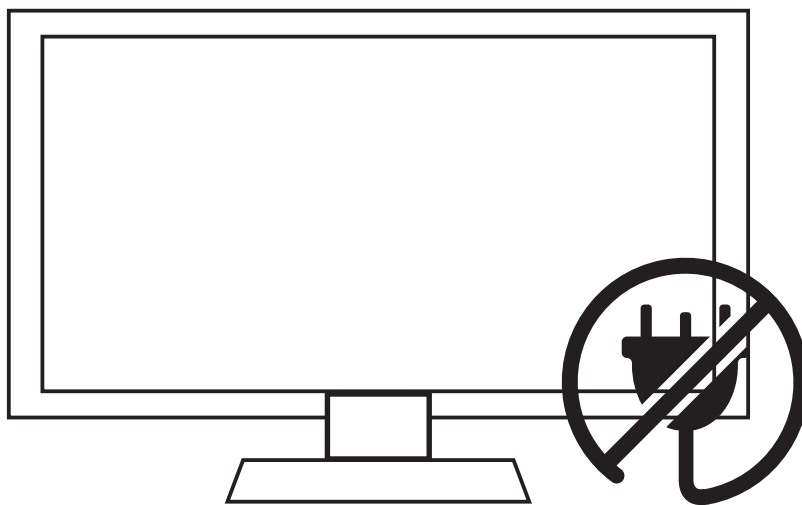

- ② HDMI Single-port Output: With both the TV and media player powered off, insert one end of the HDMI cable into the HDMI OUT MAIN port of this device and the other end into the HDMI IN port of the TV.

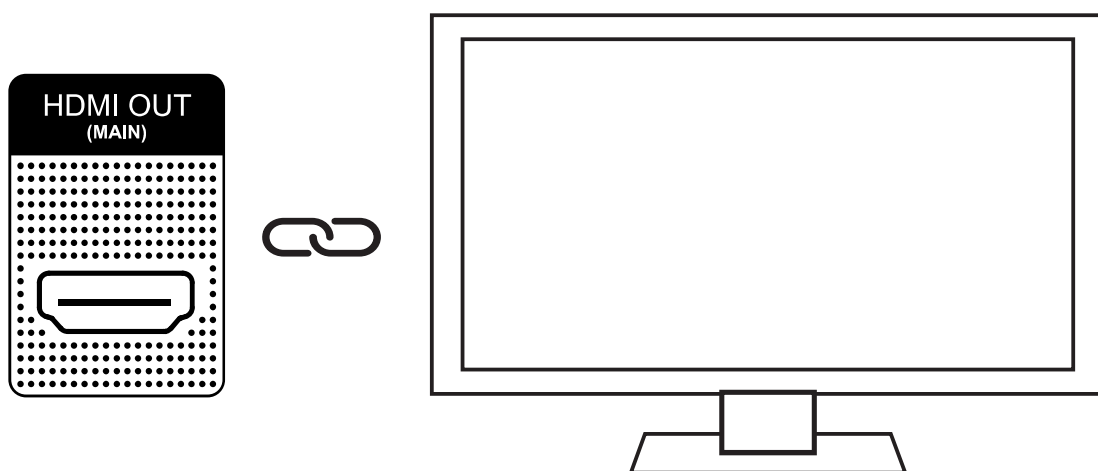

8K UHD MEDIA PLAYER

③ HDMI Dual-port Output (audio and video separate output): With both the TV and media player powered off, insert one end of an HDMI cable into the HDMI OUT AUDIO ONLY port of this device and connect the other end to the AV receiver. Then, use another HDMI cable to connect one end to the HDMI OUT MAIN port of this device and the other end to the TV's HDMI IN port. This connection will enable the separation of audio and video output.

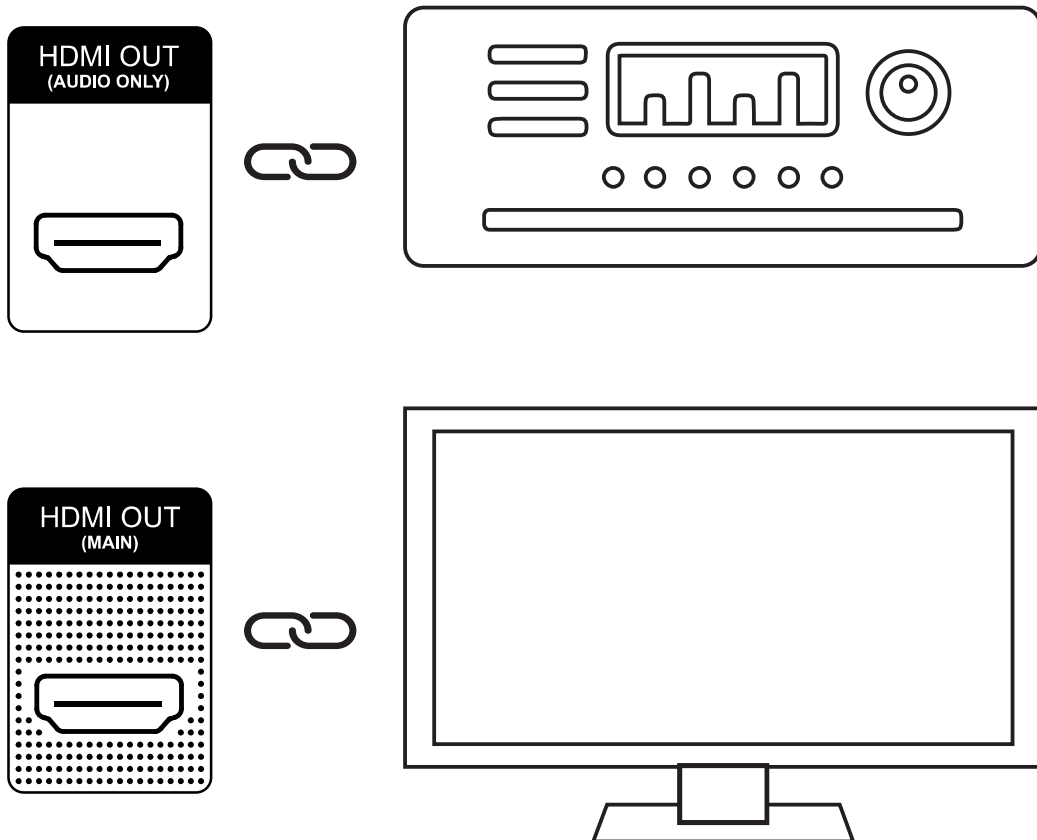

Note: The dual-port output mode is suitable for AV receivers that do not support resolutions higher than 4K or 3D functionality, and when the display device supports resolutions higher than 4K or 3D functionality.

④ Power Connection: This device has a built-in power supply module. Please insert the provided power cord into the AC power socket of the unit, and connect the other end of the power cord to an AC power outlet rated for 110~120/220~240V. Then, turn on the power switch located on the AC power socket of the unit.

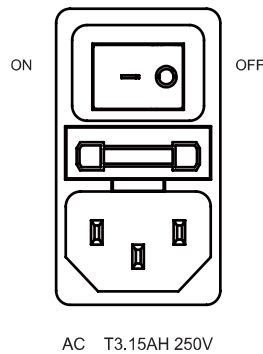

⑤ Turn on the device by pressing the power button on the left side of the front panel or pressing the power button on the remote control, and then turn on the TV.

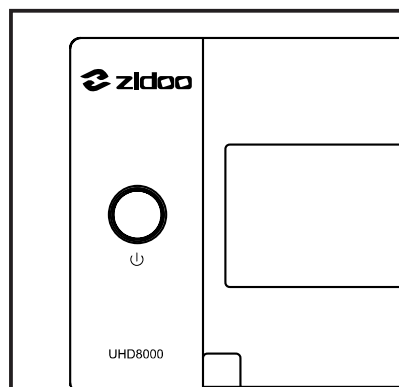

⑥ Select the corresponding video source on the TV.

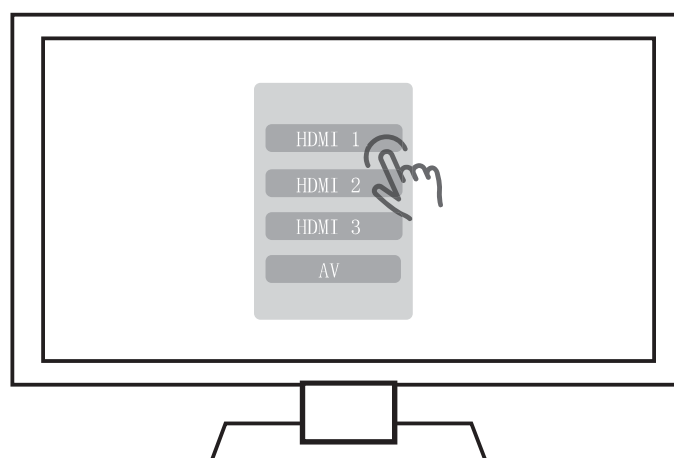

2. Other Connections

Other connection methods follow the same steps as connecting with an HDMI cable. Please connect the cables first before powering on.

Boot Initialization Wizard

1. System Language Selection, Screen Zoom, Time Zone Setting

Choose the system language.

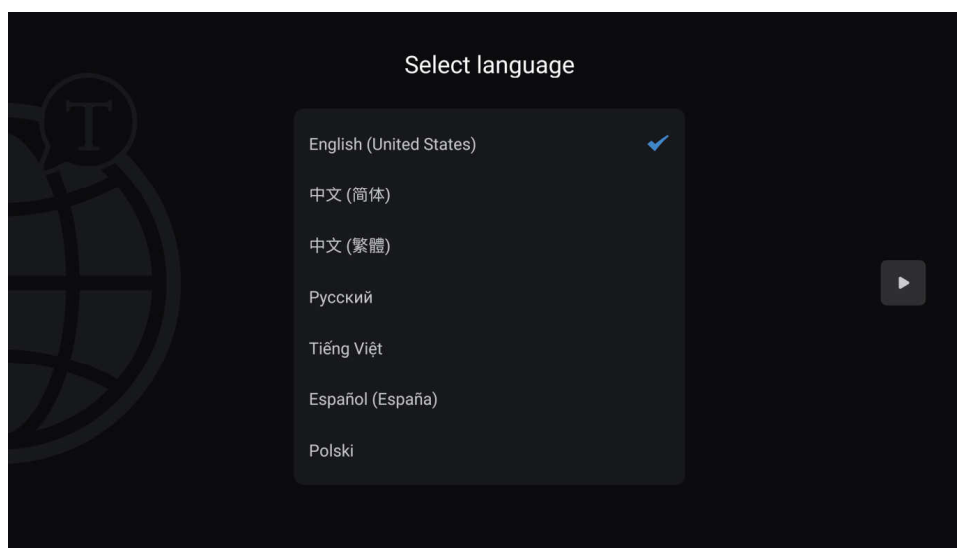

Press the UP and DOWN buttons on remote control to adjust screen display area.

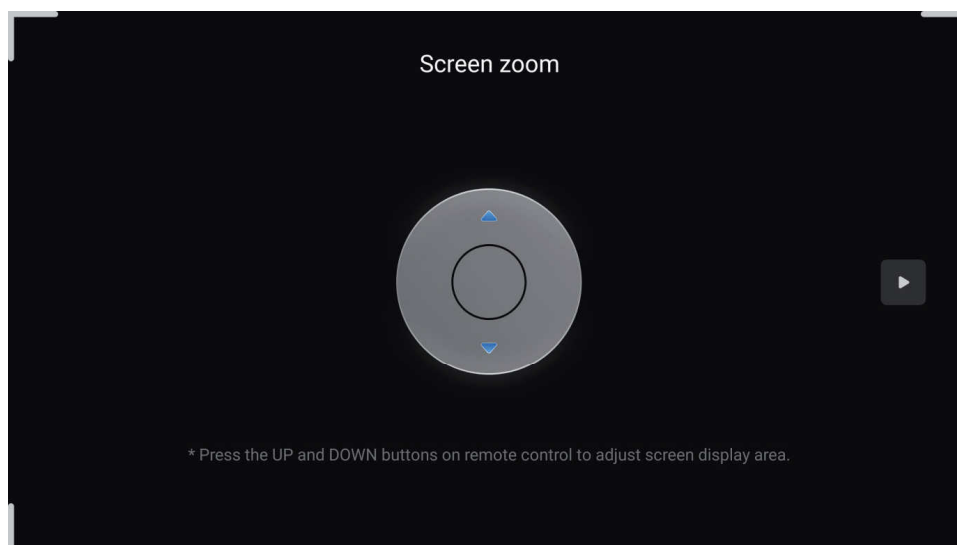

Select the time zone for the system according to your location.

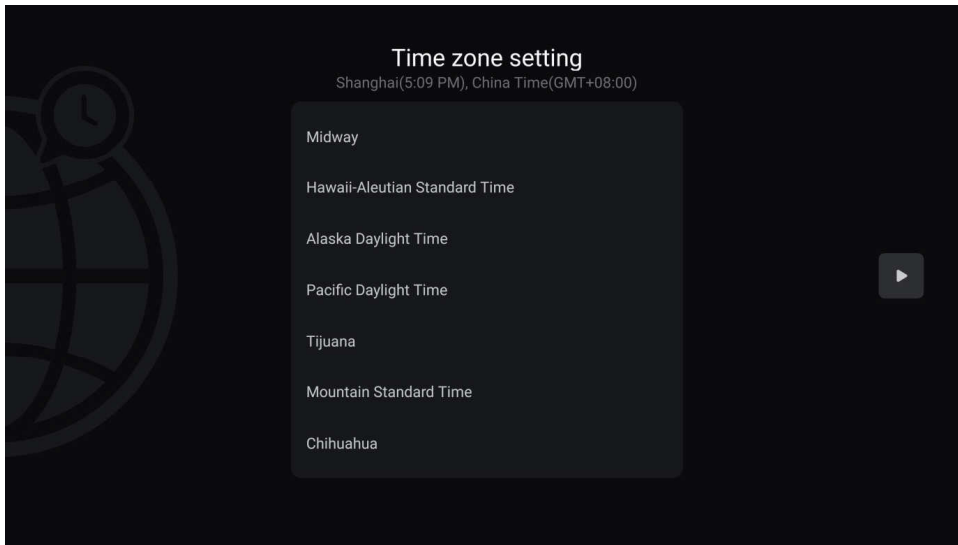

2. Network Setting

Please configure the network settings according to the specific network conditions.

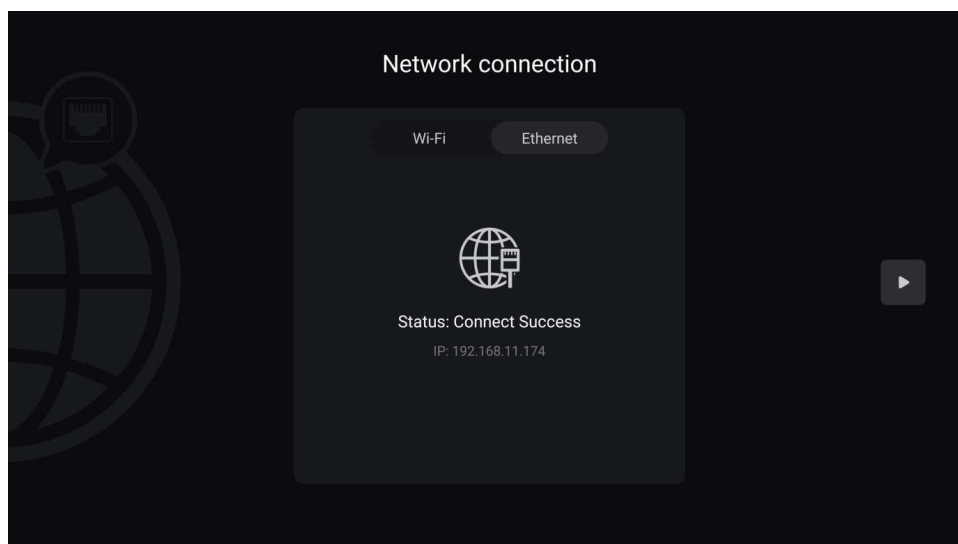

Wi-Fi: Select the network SSID, enter the password, and connect to Wi-Fi.

Ethernet: Plug in the Ethernet cable to automatically connect to the network.

3. Bluetooth Remote Control Pairing

Point the remote control at the media player, keeping a distance within 30 centimeters. Simultaneously press and hold the "Volume Down" and "Menu" keys for 5 seconds until the indicator light flashes.

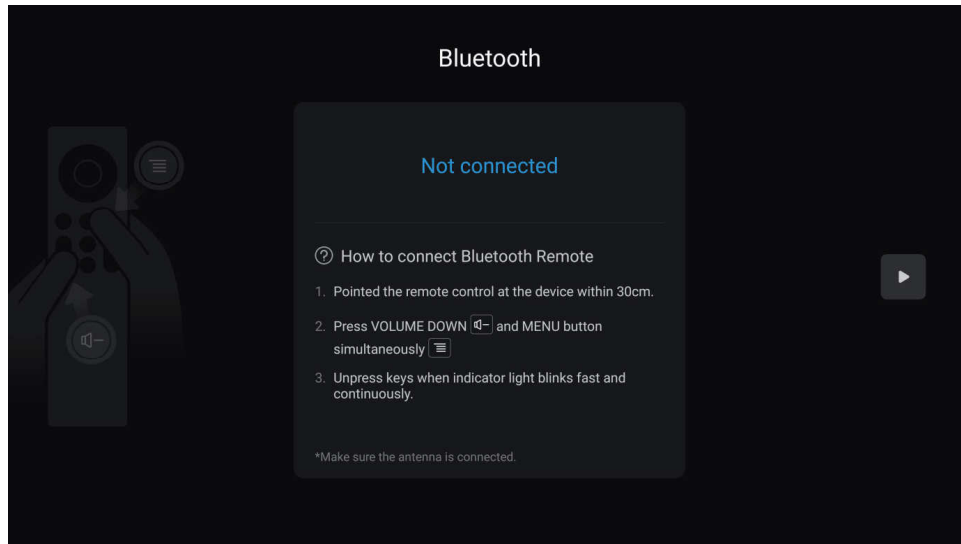

The indicator light will turn off after pairing is completed.

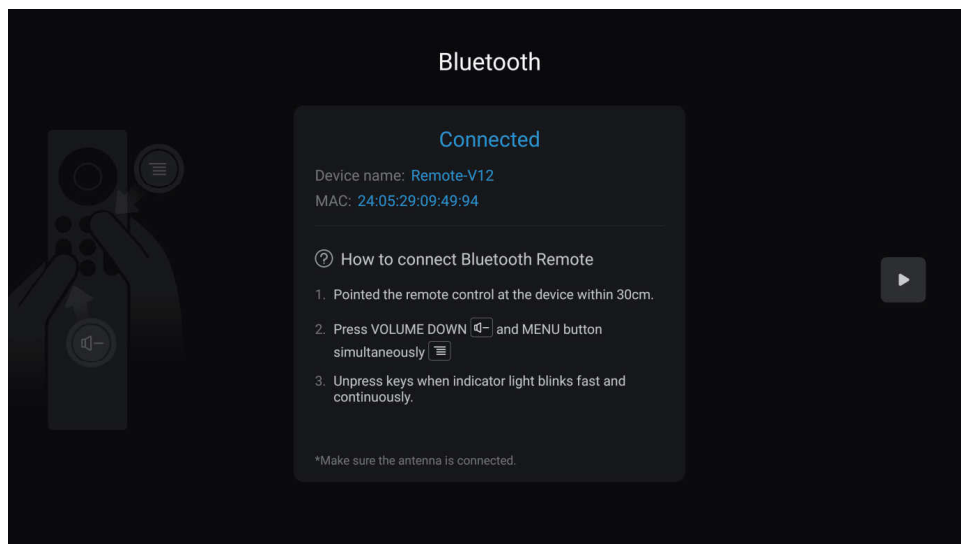

After the configuration is complete, the details of the remote control will be displayed.

4. Device Connection Methods

Choose the corresponding connection method based on your audio and video equipment.

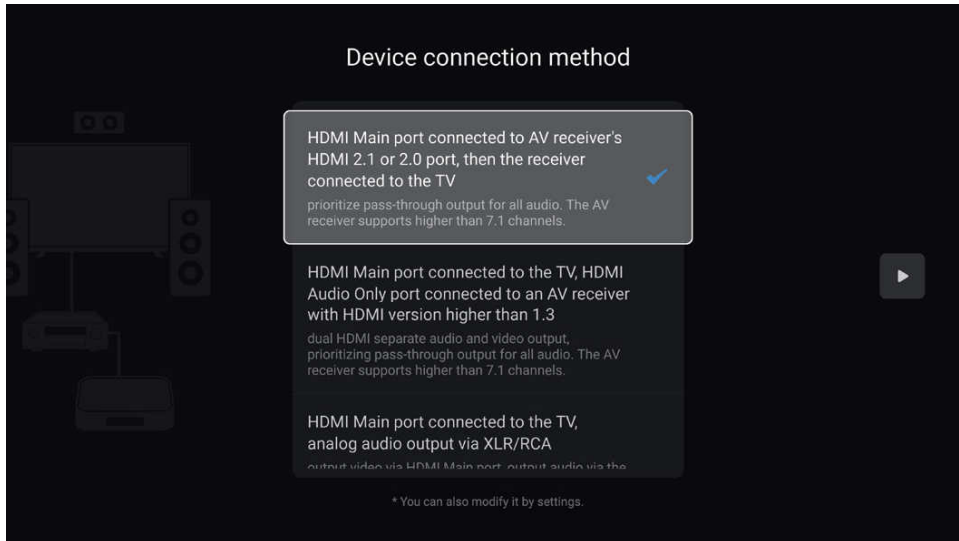

Note: The effects presented will vary depending on the different connection methods.

- HDMI Main port connected to AV receiver's HDMI 2.1 or 2.0 port, then the receiver connected to the TV: Choosing this setup, UHD8000 will prioritize pass-through output for all audio. The AV receiver supports higher than 7.1 channels.
- HDMI Main port connected to the TV, HDMI Audio Only port connected to an AV receiver with HDMI version higher than 1.3: Choosing this dual HDMI setup, UHD8000 will separate audio and video output, prioritizing pass-through output for all audio. The receiver supports higher than 7.1 channels.
- HDMI Main port connected to the TV, analog audio output via XLR/RCA: Choosing this setup, UHD8000 will output video via HDMI Main port, while outputting audio via the DAC module's XLR/RCA analog ports.
- HDMI Main port directly connected to the TV: Choosing this setup, UHD8000 will pass through or decode the audio for output according to the TV's audio decoding capability.
- HDMI Main port connected to the TV, optical or coaxial port connected to the AV receiver: Choosing this setup, the AV receiver supports up to 5.1 channels and will attempt to downmix all audio to 5.1 output.
- HDMI Main port connected to the TV, HDMI Audio Only port connected to an AV receiver with HDMI version lower than 1.3: Choosing this dual HDMI setup, UHD8000 will separate audio and video output and will attempt to downmix all audio to 5.1 output.
- HDMI Main port connected to an AV receiver with HDMI version lower than 1.3, then the AV receiver connected to the TV: Choosing this setup, UHD8000 will attempt to downmix all audio to 5.1 output.

5. The Key Definition

Define the corresponding functions for number keys, timing keys, subtitle keys, audio keys, up and down keys and page keys on the remote control according to your preference.

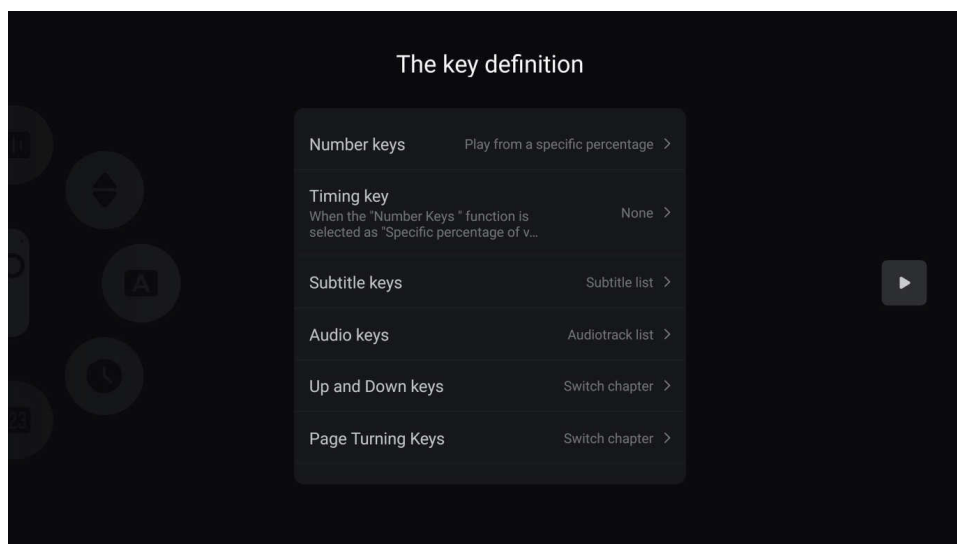

6. Phone Control

Scan the QR code on the left to download and install the ZIDOO Control App, then launch the ZIDOO Control App to scan the QR code on the right and pair with the ZIDOO media player.

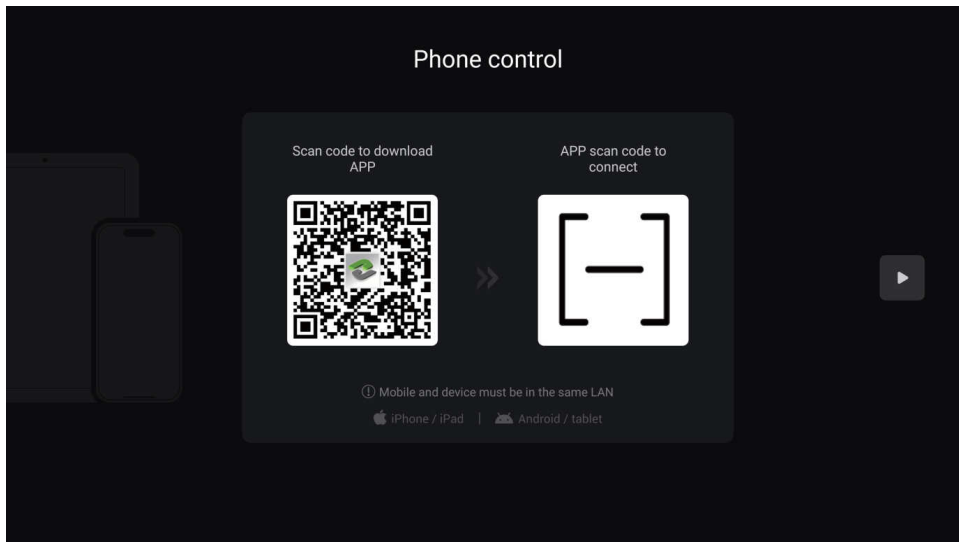

After completing the above settings, follow the prompts to click "Next" to complete the initialization setup, and then you can enjoy the audiovisual feast brought to you by ZIDOO products.

The ZIDOO Control App is compatible with Android and iOS smartphones/tablets (landscape mode). You can view the poster wall, music library data, system applications, and menus on it. You can also browse and play built-in streaming media services through the control app, enjoying a comfortable control experience.

The ZIDOO Control App supports screen mirroring, allowing you to cast the player's display screen and perform various controls on phones/tablets.

ZIDOO supports pure music mode: even without turning on the display device, you can still enjoy high-definition lossless music.

The ZIDOO Control App can remotely power on/off: it supports Wake-on-LAN (WOL) function, allowing you to remotely control the player's power switch via wired network.

The ZIDOO Control App has a floating button function, allowing you to perform various basic control functions through the floating window.

Introduction to System

1. Media Center

ZIDOO has a complete full-featured media center, which has rich and comprehensive file management functions.

- Supports direct access to external drives and automatic or manual scanning of all available NFS or SMB network drives within the local area network, providing more flexible access to media in the same LAN.
- Offers various file management methods such as multi-selection, copy, cut, delete, sort, etc.
- Supports UPnP local network sharing protocol as well as mounting and online playback of various cloud drives such as WebDAV.

2. Poster Wall

ZIDOO is equipped with a poster wall movie management system that adopts a new algorithm, featuring a simple but effective navigation interface, personalized classification based on data, and highly customizable display of viewing records, genre classifications, intelligent recommendations, and more. The highly customizable modular management greatly improves the convenience of movie collection, fully meeting users' needs for efficient management of a large number of movies.

Instructions for adding videos:

- ① When launching the poster wall for the first time, you can configure language and child lock settings. If not needed, you can skip this step.
- ② On the homepage of the poster wall, click "Open Sources."
- ③ Click "Add Source" and select a video folder (supports adding multiple folders). The path supports internal and external storage, SMB, NFS, etc.
- ④ After configuring the scan options, click "Start Scan" and wait for the poster wall to finish loading.

Note: It is recommended to use intelligent scraping sources for the poster wall.

3. Music Player

The UHD8000 music player provides powerful local music playback performance and management functions, allowing you to add music files from local hard drives or network storage across platforms. The music player automatically retrieves music information, matches music artists, album covers, local CUE files, etc., to construct an exclusive music database for us. It supports personalized classification display of music genres, sampling rates, albums, artists, etc., and supports functions such as creating favorite playlists.

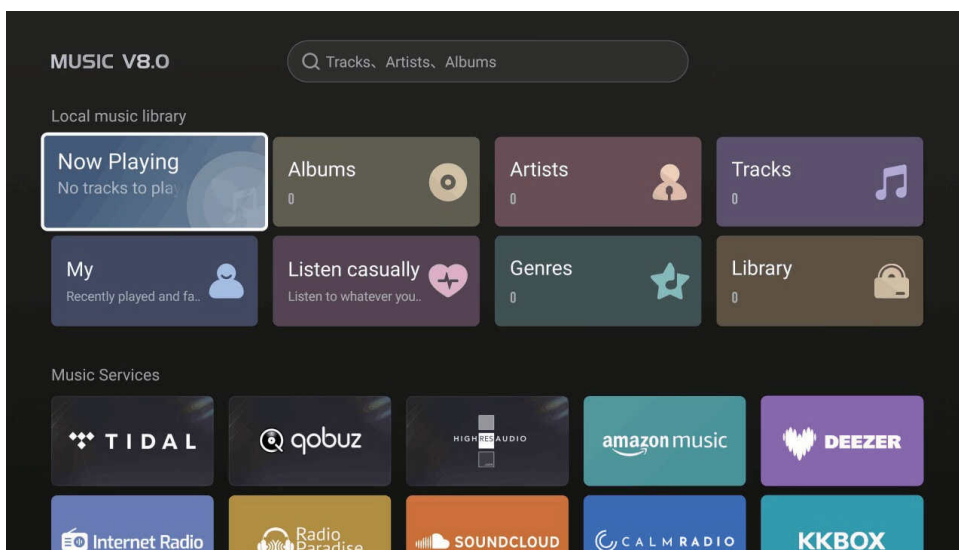

3.1 Instructions for Adding Music to Local Music Library

- ① Go to the "Library" section on the music player's homepage.
- ② Select and click on "Add Library".
- ③ Choose a music folder (supports adding multiple folders), with paths supported from internal and external storage, SMB, NFS, etc. After selecting, click "OK".
- ④ Finally, wait for the music player to finish scanning.

3.2 CD Playback and Ripping

The UHD8000 supports not only the playback of CDs via an external CD-Rom but also features a specially developed CD Ripping application. Utilizing unique data verification mechanisms and error correction functionalities, it ensures the lossless preservation and storage of CD audio data.

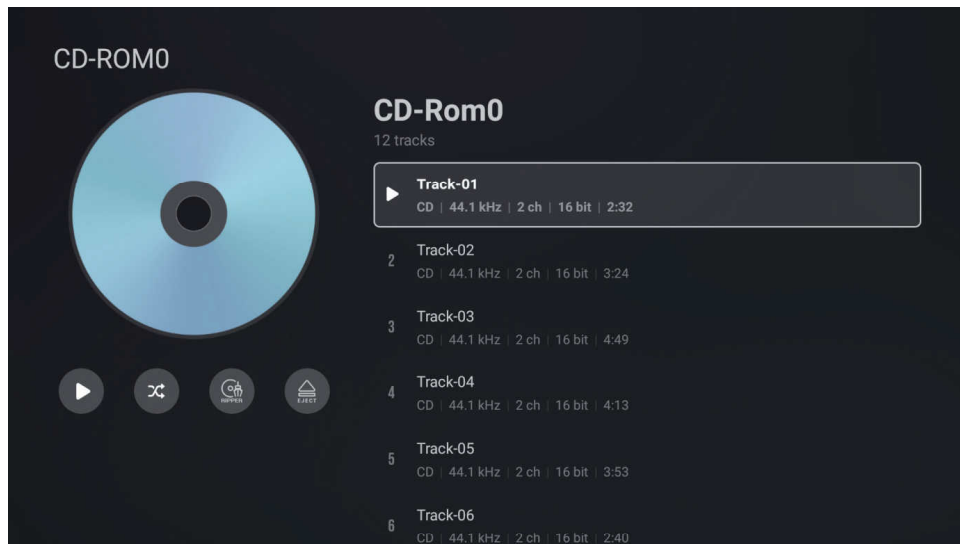

3.3 Music Player Settings Introduction

Access Guide: Pull down to the bottom of the homepage of the music player to enter the settings menu.

Play: The play menu includes features such as album skipping playback, folder skipping playback, playlist skipping playback, auto-play queue on startup, and entering to the playback interface once start playing.

Scan: The scan menu includes features such as matching method, prioritizing local images, not scanning songs under 500kb, automatic updating sources, and scanning music formats.

Display: The display menu includes features of displaying playback details with a background image.

General: The general menu includes features such as backup and restore, resetting the music library, and clearing the cache etc.

4. Applications

Display all installed applications on the player, including built-in and third-party applications. By pressing the App icon, you can bring up the function menu, which supports settings such as launch on start-up, clear data, and uninstall (third-party applications).

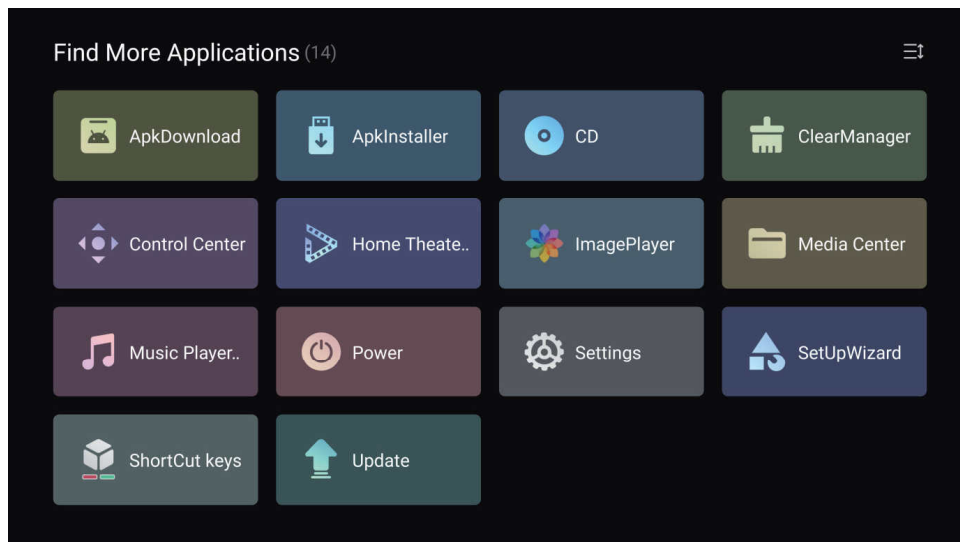

5. Settings

Access Guide: On the homepage, click the "  " icon on the far right.

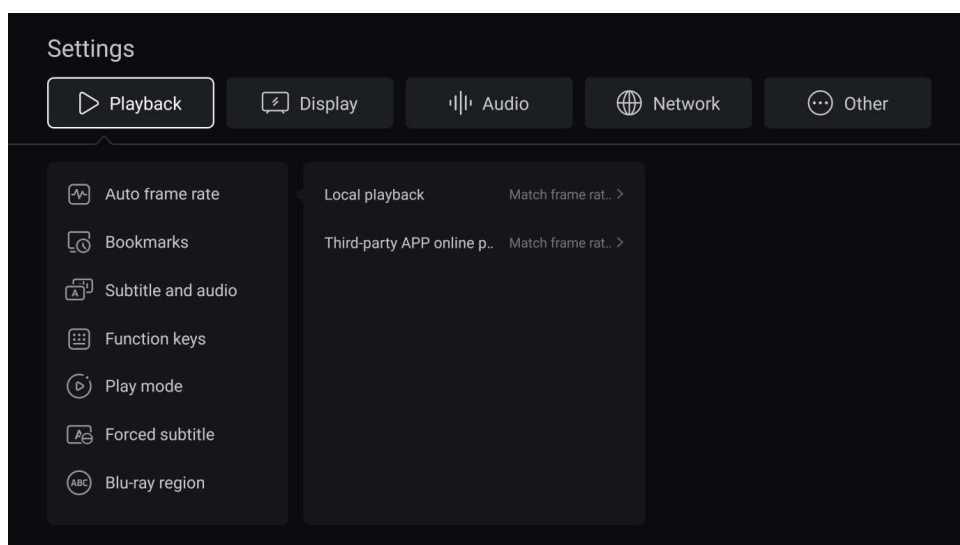

5.1 Playback

The playback settings include features such as auto frame rate, bookmarks, subtitles and audio, function keys, playback mode, forced subtitle, Blu-ray region, subtitle download, digital signage mode, and other functionalities.

Auto Frame Rate

ZIDOO media players support precise automatic switching of native resolution and frame rate (support 23.976, 24, 25, 29.97, 30, 50, 59.94, 60) for both local and third-party app online playback. It uses a new automatic switching algorithm that completes the pre-switching before the movie starts, ensuring the completeness of the movie presentation.

ZIDOO supports auto frame rate settings for both "local playback" and "third-party app online playback." You can choose to turn off auto frame rate; Alternatively, you can select "match frame rate only", when playing a video, the player will automatically switch to the same frame rate as the source. Additionally, you can choose "match frame rate and resolution", when playing a video, the player will automatically switch to the same resolution and frame rate as the source.

Note: Enabling this option will require HDMI to re-handshake at the start and end of video playback, causing the display device to go black for a few seconds.

5.2 Display

In the display settings, there are options for resolution, color settings, HDR, custom EDID, screen scale, picture parameters, AI image process, UI interface resolution, screensaver, wallpaper, and other function settings.

① Color Settings

Set the player's color space and color depth priority for output at 8K, 4K, and below 4K resolutions, as well as the HDMI signal format. The HDMI format can be set to either Standard or Enhanced format.

Notes:

* When you select the Enhanced format, if your display device supports it, you will be able to achieve a maximum output of 8K 422 12-bit.

* Please ensure you are using a high-quality HDMI cable that supports 48G bandwidth.

② HDR Settings

- UI Display Mode: The UI display mode can be set to one of three options: SDR, HDR, or DV.

- HDR Output Mode:

Auto: The player adapts to output the optimal image mode based on the source and the display device's capabilities.

Dolby Vision Output Mode: When the display device supports both TV-led and LLDV Dolby Vision modes, this option will appear in the menu and allow for custom switching. If the display device supports only either TV-led or LLDV, this option will be hidden and the player will automatically adapt its output. If the display device does not support Dolby Vision, this option will automatically be hidden and will not be functional.

Advanced Settings: Advanced mode allows different types of content to be converted to another format as needed. Additionally, the VS10 Dolby Vision engine can be customized to engage based on the content. This feature provides professional users with greater flexibility, while regular users can set it to automatic.

HDR Advanced Settings

Video Format	Output Mode
SDR Content Output Mode	SDR (default) ,HDR,DV
HDR10 Content Output Mode	SDR,HDR (default) ,DV
HDR10+ Content Output Mode	SDR,HDR,HDR10+ (default) ,DV
HLG Content Output Mode	SDR,HLG (default) ,DV
DV Content Output Mode	SDR,HDR,DV (default)
Dolby VS10 for SDR Content	Yes,No (default)
Dolby VS10 for HDR10 Content	Yes,No (default)
Dolby VS10 for HDR10+ content	Yes,No (default)
Dolby VS10 for HLG Content	Yes,No (default)
Dolby VS10 for DV Content	Yes,No (default)

③ AI Image Process

- **AI Image Enhancement:** Using artificial intelligence to identify the content scene and adjust the color saturation, brightness, sharpness, dynamic compensation, and intelligent noise reduction of the picture frame by frame according to different scenes, thereby enhancing the overall image quality.

- **Enable AI SR(super-resolution):** By utilizing upscaling technology and deep learning capabilities to achieve image super-resolution, it can intelligently enhance the resolution of content presented from streaming media, cable TV, and discs, making the picture clearer. Combined with MEMC dynamic compensation, it can provide a more spectacular 4K viewing experience.

Note: AI image enhancement only applies to videos with 1080P resolution or lower and is effective when the current output is higher than 1080P. Please disable the "Match frame rate and resolution" feature when enabling this option.

5.3 Audio Settings

The audio settings include switching the audio source, and advanced settings for audio ports such as XLR/RCA audio output, HDMI Main port output, HDMI Audio port output, SPDIF output, and USB audio output.

① Source Settings

- **Internal Player:** Play audio and video directly using the internal player.

Analog Ports	DAC Output Capability
BAL-XLR	Supports up to DSD512 / PCM768Khz 32bit
Analog-RCA	
XLR/RCA	
Digital Ports	Output Capability
HDMI Main Port	Supports Dolby Atmos and DTS-X, with downward compatibility
HDMI Audio Port	Supports Dolby Atmos and DTS-X, with downward compatibility; Supports DSD Native
OPT/COAX	Supports up to PCM192Khz
USB Audio Output	Supports up to DSD512 / PCM768Khz 32bit

● **USB Audio In:** USB audio input of external device is decoded and output by the player's DAC (supports Win10, Win11, Android, iOS systems).

Output Port	DAC Output Capability
BAL-XLR	Supports up to DSD512 / PCM768Khz 32bit
Analog-RCA	
XLR/RCA	

● Delay Playback

When the HDMI Main port, Audio port, OPT/COAX connection to the AV preamp, and USB connection to the preamp are connected, changes in the sampling rate can cause the first few seconds of the track to be silent due to the audio recognition speed of the preamp. This option can be set to delay playback to avoid this situation. Please adjust the appropriate delay time according to the response speed of your preamp.

Note: This feature only applies to pure audio, supporting delay adjustment from 0 to 5000ms.

5.4 Network Settings

This menu supports settings for Wi-Fi, Ethernet, Bluetooth, Samba server, portable hotspot, and other functions.

5.5 Other Settings

This menu includes advanced settings such as language, HDMI CEC, power mode, HDD sleep, fan control, front display panel, keyboards, date and time, show hourly time, main interface weather, upgrade, recovery and reset, and about, etc.

● HDMI CEC

CEC, short for Consumer Electronics Control, is a means of control conducted through HDMI. CEC control allows users to enjoy many conveniences by using a single remote to control multiple CEC-enabled devices such as TVs, set-top boxes, etc.

HDMI CEC	Function Introduction
TV wakes up the Media Player	---
TV turns off the Media Player	---
Media Player wakes up TV	---
Media Player turns off TV	---
TV remote controls Media Player	The direction keys, OK key, menu key, and return key on the TV remote control can be used to control the media player
Media Player controls TV volume	When the HDMI audio settings are set to pass-through, the volume keys on the ZIDOO remote control will control the TV volume
Media Player controls AVR volume	When the HDMI audio settings are set to pass-through, the volume keys on the remote control of the ZIDOO will control the AVR volume
One Touch Play of Home key	When the TV has multiple signal sources input and is not currently on the ZIDOO source, pressing the ZIDOO remote's home key once will automatically switch the TV to the ZIDOO source
Inactive source turns off Media Player	When the TV has multiple signal sources input and is currently on the ZIDOO source, switching the TV to another source will automatically close the media player

Note:

*HDMI CEC only works on the HDMI Main port.

*When HDMI is set to pass-through output, this function will send the control signal of the local speaker through CEC to the AV receiver or TV and other devices. Please make sure that other devices have CEC enabled when using this function. This function may have compatibility issues, and not all devices can be controlled.

Remote Control

Source

1. Source Switch: Press the "  " button in the upper right corner of the remote control to switch between the player's output ports: balanced XLR, analog RCA, HDMI Main port, HDMI audio port, and optical/coaxial.

2. Access Guide: Press any undefined color key on the remote control or open the Shortcut keys from all applications.

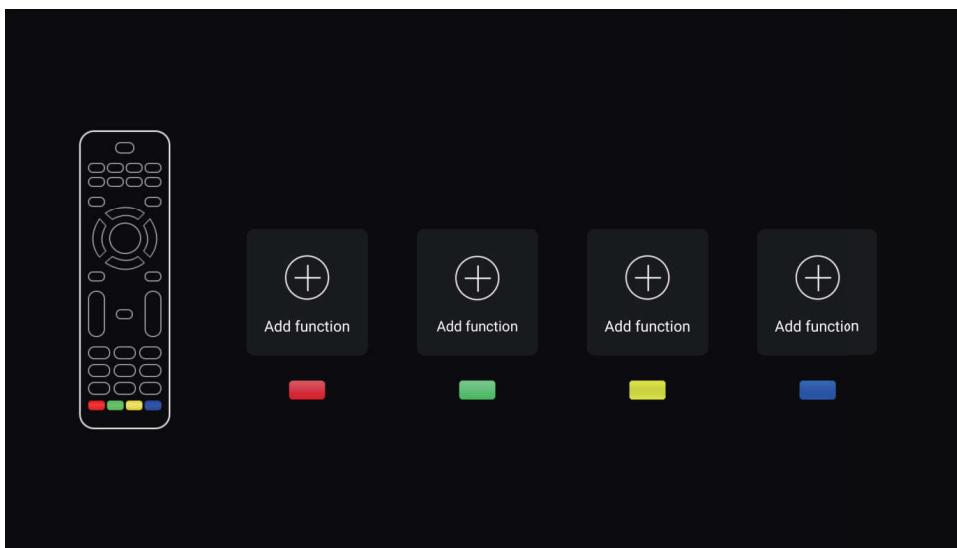

3. This function allows you to customize the remote control's red, green, and blue color keys as shortcuts for specific functions; supports customization such as music play queue, music now playing, AI image process, etc.

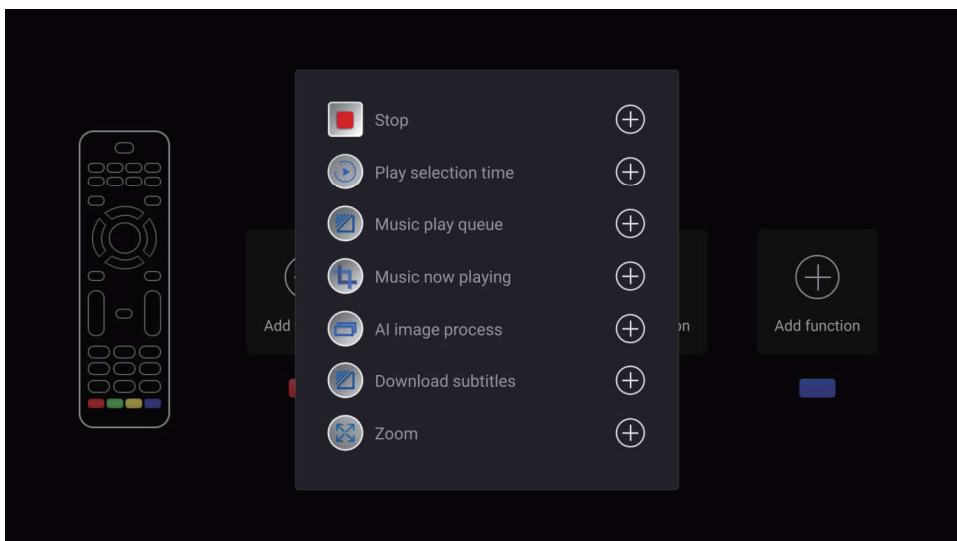

OTA System Update

ZIDOO will update the firmware from time to time.

Find the update icon in APPs and click it, online update and local update are supported. After ticking "Automatically check online upgrade" , you will receive the prompt for the latest firmware update automatically.



1. Online Update

Click the "Online Update" option to receive online update information and proceed with the update.

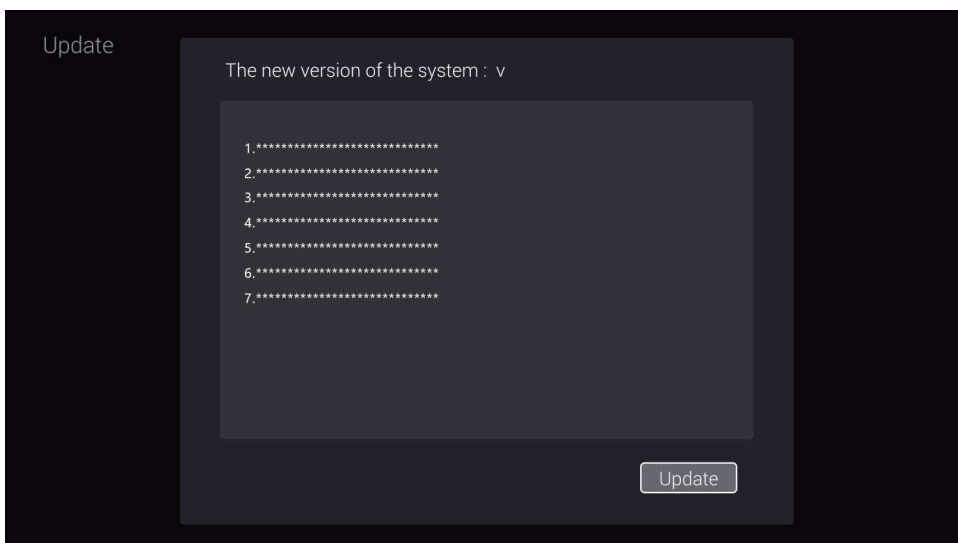

2. Local Update

① Users can manually download the update file from the forum or official website and update the system locally. Copy the downloaded update file to a USB drive (no need to unzip it), and then click the "USB Update" option to select the update file.

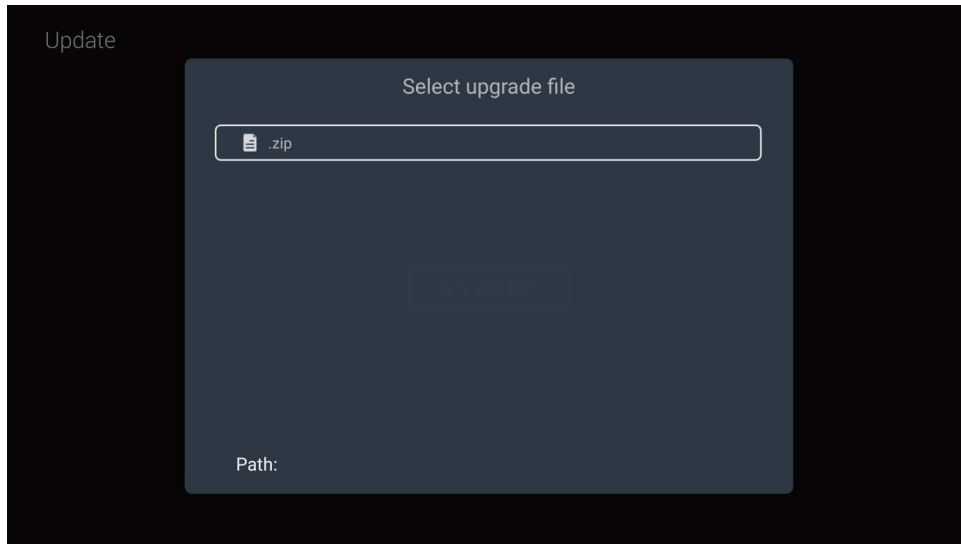

② After downloading the update file via online or USB Update, the system will automatically verify the integrity of the system file and begin the update.

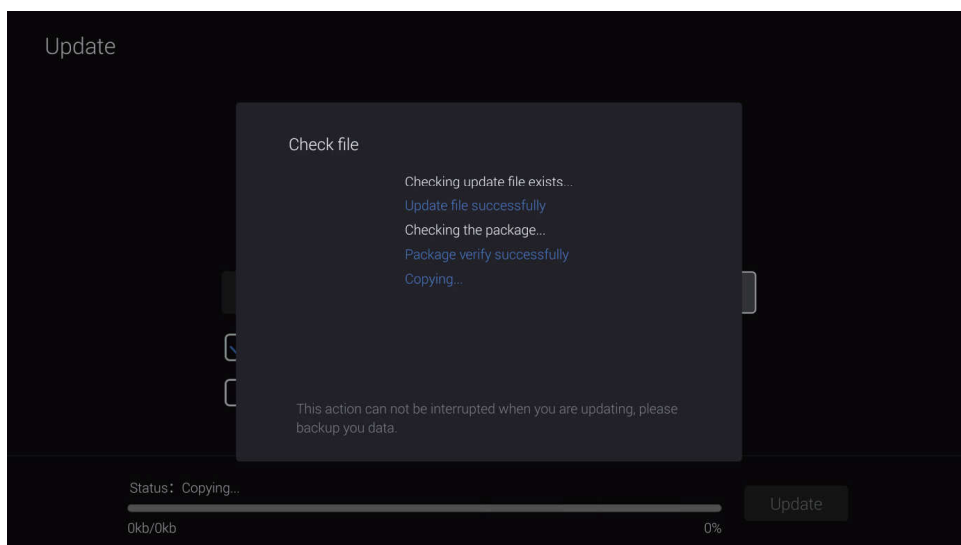

Note: System will update automatically, please do not power off.

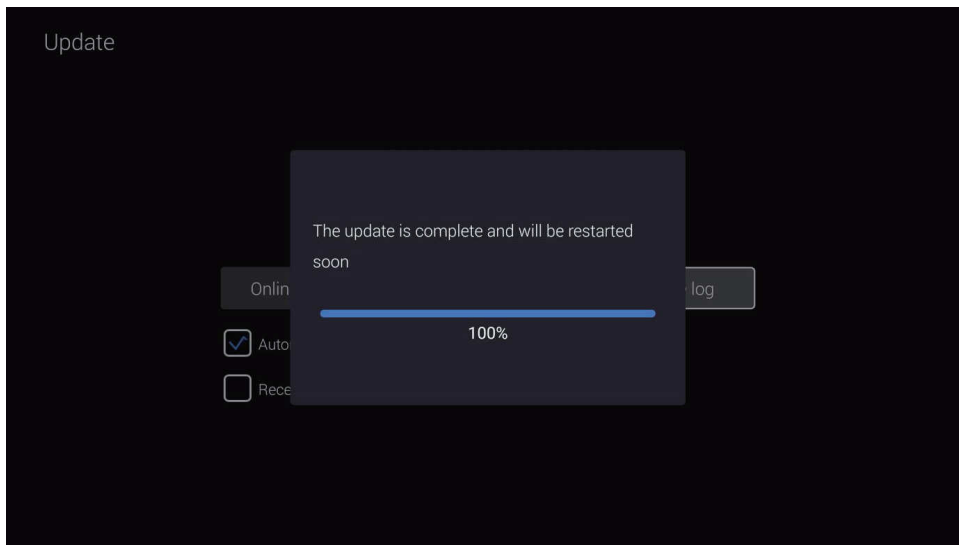

Once the update is completed, the system will automatically be restarted.

Special note:

To guarantee user experience, ZIDOO will update the firmware occasionally. Therefore, this manual may not be totally in line with the product.

Safety Warnings:

1. This device must not be exposed to splashes or drips of water, and items filled with liquids, such as vases, must not be placed on the device.
2. The AC power socket of this product is equipped with a disconnect device. The socket intended for use with this product should be installed near the product and should be easily accessible, without being obstructed by other objects.
3. This product is a Class I device, and the internal chassis must be grounded during use.

商标信息 / Trademark information

- The terms HDMI and HDMI High-Definition Multimedia Interface, and the HDMI Logo are trademarks or registered trademarks of HDMI Licensing LLC in the United States and other countries.
- HDMI 和 HDMI High-Definition Multimedia Interface 专用名词以及 HDMI 标志是 HDMI Licensing LLC 在美国和其他国家的商标或注册商标。
- Dolby, Dolby Audio and the double-D symbol are trademarks of Dolby Laboratories Licensing Corporation.
- 杜比、Dolby、Dolby Audio、和双D 符号是杜比实验室的注册商标。
- For DTS patents, see <http://patents.dts.com>. Manufactured under license from DTS Licensing Limited. DTS, the Symbol, & DTS and the Symbol together are registered trademarks, and DTS 2.0+ Digital Out is a trademark of DTS, Inc. © DTS, Inc. All Rights Reserved.
- 有关 DTS 专利，请访问<http://patents.dts.com>。由 DTS, Inc. 授权制造。DTS、标志和 DTS 连同其标志是 DTS, Inc. 的注册商标，DTS 2.0+ Digital 是 DTS, Inc. 的商标，© DTS, Inc. 版权所有。



TEL: 400-180-9091

www.zidoo.tv