



USER MANUAL

MODEL:

VP-554X

Presentation Switcher/Scaler

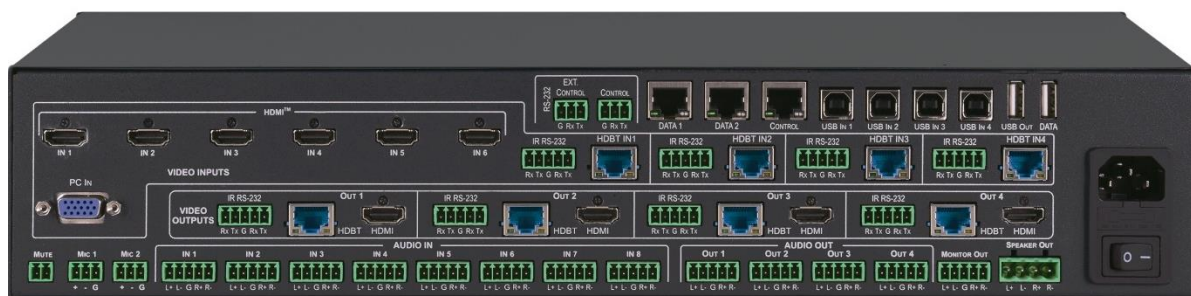
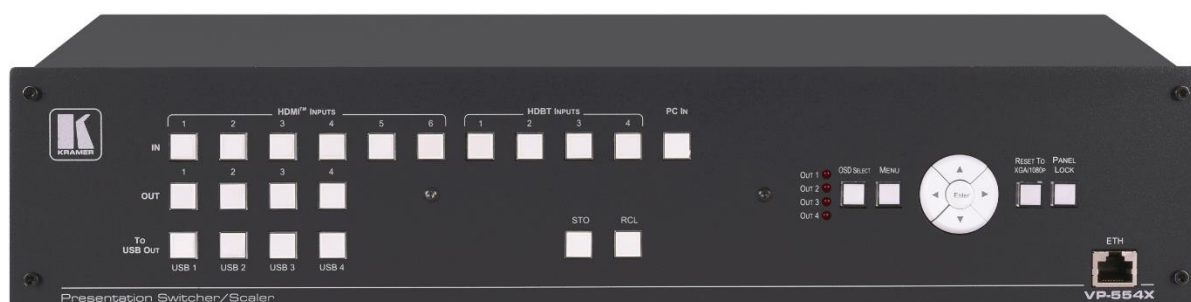

Contents

Introduction	1
Getting Started	1
Overview	2
Typical Applications	4
Defining VP-554X Presentation Switcher/Scaler	5
Mounting VP-554X	8
Connecting VP-554X	9
Connecting the Output to a Balanced/Unbalanced Stereo Audio Acceptor	10
Connecting a Balanced/Unbalanced Stereo Audio Source to the Input	11
Connecting to VP-554X via RS-232	11
Wiring RJ-45 Connectors	11
Operating and Controlling VP-554X	12
Routing an input to an output	12
Routing a USB input to the USB output	12
Storing (STO) and Recalling (RCL) Outputs Via the Front Panel	12
Resetting the Resolution	13
Locking the Front Panel	13
Controlling Device Operation Via the OSD Menu	13
Operating via Ethernet	27
Using Embedded Web pages	30
Browsing Web Pages	30
Switching and Setting Ports	32
Adjusting the Output Image	39
Changing Device Settings and Upgrading Firmware	41
Routing the USB Switcher	42
Defining Audio Parameters	44
Managing EDID	49
Setting Ethernet Data Routing	51
Setting up for RS-232 External Device Control	53
Configuring a Video Wall	56
Viewing System Diagnostics	58
Setting Webpage Access	59
Setting Timeout	61
Viewing About Page	62
Technical Specifications	63
Default Communication Parameters	65
Default EDID	65
Protocol 3000	68
Understanding Protocol 3000	68
Protocol 3000 Commands	69
Result and Error Codes	86

Introduction

Welcome to Kramer Electronics! Since 1981, Kramer Electronics has been providing a world of unique, creative, and affordable solutions to the vast range of problems that confront the video, audio, presentation, and broadcasting professional on a daily basis. In recent years, we have redesigned and upgraded most of our line, making the best even better!

Getting Started

We recommend that you:

- Unpack the equipment carefully and save the original box and packaging materials for possible future shipment.
- Review the contents of this user manual.



Go to www.kramerav.com/downloads/VP-554X to check for up-to-date user manuals, application programs, and to check if firmware upgrades are available (where appropriate).

Achieving Best Performance

- Use only good quality connection cables (we recommend Kramer high-performance, high-resolution cables) to avoid interference, deterioration in signal quality due to poor matching, and elevated noise levels (often associated with low quality cables).
- Do not secure the cables in tight bundles or roll the slack into tight coils.
- Avoid interference from neighboring electrical appliances that may adversely influence signal quality.
- Position your Kramer **VP-554X** away from moisture, excessive sunlight and dust.

Safety Instructions



Caution:

- This equipment is to be used only inside a building. It may only be connected to other equipment that is installed inside a building.
- For products with relay terminals and GPIO ports, please refer to the permitted rating for an external connection, located next to the terminal or in the User Manual.
- There are no operator serviceable parts inside the unit.



Warning:

- Use only the power cord that is supplied with the unit.
- Disconnect the power and unplug the unit from the wall before installing.
- Do not open the unit. High voltages can cause electrical shock! Servicing by qualified personnel only.
- To ensure continuous risk protection, replace fuses only according to the rating specified on the product label which is located on the bottom of the unit.

Recycling Kramer Products

The Waste Electrical and Electronic Equipment (WEEE) Directive 2002/96/EC aims to reduce the amount of WEEE sent for disposal to landfill or incineration by requiring it to be collected and recycled. To comply with the WEEE Directive, Kramer Electronics has made arrangements with the European Advanced Recycling Network (EARN) and will cover any costs of treatment, recycling and recovery of waste Kramer Electronics branded equipment on arrival at the EARN facility. For details of Kramer's recycling arrangements in your particular country go to our recycling pages at www.kramerav.com/il/quality/environment.

Overview

Congratulations on purchasing your Kramer **VP-554X Presentation Switcher/Scaler**.

The **VP-554X** is a high-performance presentation scaler/switcher with 4 pairs of independent and scaled outputs. It includes multiple HDMI and HDBaseT inputs – supporting resolutions up to 4K – as well as a legacy VGA input, and each of the 4 outputs is mirrored on both HDMI and HDBT.

VP-554X supports embedded and balanced analog stereo audio, up to 2 microphone inputs, DSP audio features and a built-in stereo power amplifier. It includes a built-in Ethernet switch and supports legacy RS-232, and IR, Ethernet and RS-232 tunneling over HDBT.

VP-554X provides exceptional quality, advanced and user-friendly operation, and flexible control.

Exceptional Quality

- Pix-Perfect™ Scaling Technology – Kramer's precision pixel mapping and high-quality full up - and down-scaling technology.
- High-Performance Switcher/Scaler – Scales the video and provides constant output sync to prevent signal disruption when switching between inputs and when no video is detected.
- HDCP 2.3 Compliance – The HDCP (High Definition Content Protection) license agreement allows copy-protected data on the HDMI input to pass to HDCP compliant outputs.
- Resolutions – Up to 4K60 4:4:4 on the HDMI ports; up to 4K60 4:2:0 on the HDBaseT ports; and up to 1080p60 on the VGA input.
- System Range for the HDBT inputs and outputs – up to 100m for 4K; 180m for 1080p.
- Each HDBaseT port supports PoE.
- 4x1 USB Switcher – Can be set to follow the switching of the video layer or as an independent switcher.
- Audio DSP Features, including input and output level adjustments, microphone talkover, mixing, and EQ.
- Analog & Embedded Audio Support.

- Built-in Power Amplifier – 2x20W.
- Built-in Video ProcAmp – Color, hue, sharpness, noise, contrast, and brightness.
- Option for video wall output mode.
- Multiple Control Options – Front panel buttons with OSD, RS-232, Ethernet and built-in Web pages.
- Includes numerous filters and algorithms for eliminating picture artifacts.
- Converts to 4K60 4:2:0 on HDBaseT outputs when its corresponding mirrored HDMI output resolution is 4K60 4:4:4 (similarly for 4K50).
- HDMI Support – HDR10, CEC, xvYCC color (on input), Dolby TrueHD/DTS-HD Master Audio (by-pass), as specified in HDMI 2.0 as specified in HDMI 2.0.
- Multiple aspect ratio selections.
- Advanced EDID management per input.
- Includes non-volatile memory that retains the last settings, after switching the power off and then on again.

Advanced and User-friendly Operation

- Multiple aspect ratio selections.
- STO and RCL buttons, a RESET TO XGA/1080P button (to hardware-reset the output resolution); and a PANEL LOCK button.
- Built-in video Proc-Amp – color, hue, sharpness, contrast, and brightness are set individually for each output.
- An OSD (On-Screen Display) – for making adjustments – that can be located anywhere on the screen.
- Efficient power-saving features.
- Field upgradable firmware.
- Advanced EDID management per input.
- Includes non-volatile memory that retains the last settings, after switching the power off and then on again.

Flexible Connectivity

- 11 input buttons for switching a selected input to an output.
- Scaled video outputs – 4 pairs of mirrored HDMI and HDBT outputs.
- Embedded audio on the HDMI and HDBT inputs and outputs.
- One stereo speaker output, 20W per channel into 4Ω, on a 4-pin terminal block connector.

Typical Applications

VP-554X is ideal for the following typical applications:

- Presentation and multimedia.
- Projection systems in conference rooms, boardrooms, auditoriums, hotels and churches, production studios, rental and staging.
- Any application where high quality conversion and switching of multiple and different video signals to graphical data signals is required for display or projection purposes.

Controlling your VP-554X

Control your VP-554X directly via the front panel push buttons (with on-screen menus), or:

- By RS-232 serial commands transmitted by a touch screen system, PC, or other serial controller.
- Via the Ethernet using built-in user-friendly web pages or serial commands.

Defining VP-554X Presentation Switcher/Scaler

This section defines VP-554X.

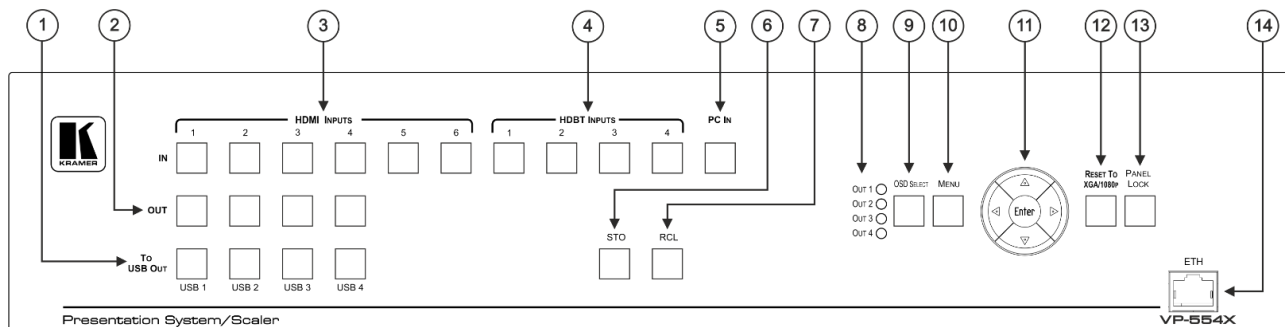

Figure 1: VP-554X Presentation Switcher/Scaler Front Panel

#	Feature	Function
①	To USB OUT Buttons (1 to 4)	Press a USB button to switch a USB input (1 to 4) to the USB output.
②	OUT Buttons (1 to 4)	Press an OUT button followed by an IN button to switch an input to a selected output.
③	IN Buttons	HDMI INPUTS Press an HDMI INPUT button to switch an HDMI input to a selected output.
④		HDBT INPUTS Press an HDBT INPUT button to switch an HDBT input to a selected output.
⑤		PC IN Press to switch the PC (VGA) input to a selected output.
⑥	STO Button	Press and hold (until button flashes once) to store the current configuration of the unit.
⑦	RCL Button	Press and hold (until button flashes once) to recall the stored configuration.
⑧	OSD OUT LEDs	Indicates on which output the OSD is currently displayed (OUT 1 to OUT 4).
⑨	OSD SELECT Button	Press to select the output on which the OSD will be displayed (cycles through OUT 1 to OUT 4).
⑩	MENU Button	Press to display the OSD menu.
⑪	Navigation Buttons	◀ Press to decrease numerical values or select from several definitions.
		▲ Press to move up the menu list values.
		▶ Press to increase numerical values or select from several definitions.
		▼ Press to move down the menu list.
		ENTER Press to accept changes and change the SETUP parameters.
⑫	RESET TO XGA/1080p Button	Press and hold for about 2 seconds to set the output resolution to XGA (1024x768). Press and hold for about 5 seconds to set the output resolution to 1080p.
⑬	PANEL LOCK Button	Press and hold for about 3 seconds to lock/unlock the front panel buttons.
⑭	ETH RJ-45 Port	Connect to a PC via a LAN to control the device and for firmware upgrade. (All 4 ETH ports, ⑭, ⑰ and ⑱ are connected to an internal Ethernet switch for convenience of connecting several network devices).

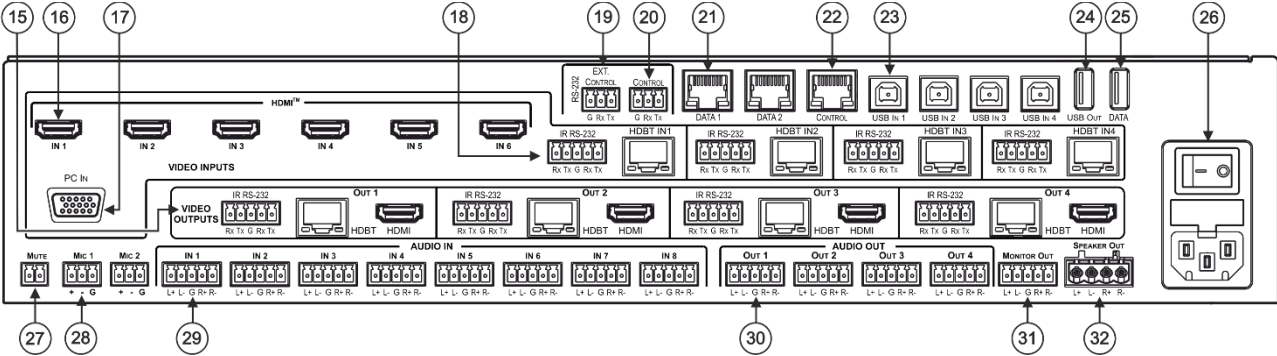



Figure 2: VP-554X Presentation Switcher/Scaler Rear Panel

#	Feature	Function
15	VIDEO OUTPUT Connectors (OUT 1 to OUT 4)	IR (Rx, Tx) left 2-pins on a 5-pin Terminal Block Connector Connect to the IR connector of an HDBT input (Tx to Rx and Rx to Tx), to tunnel IR data between an HDBT receiver on an output and an HDBT transmitter on an input.
		RS-232 (G, Rx, Tx) right 3-pins on a 5-pin Terminal Block Connector Tunnel RS-232 data between the HDBT port and the HDBT receiver: Connect to serially control a device connected to the HDBT receiver; or to serially control a local device using a controller connected to the HDBT receiver.
		HDBT RJ-45 Connector Connect to an HDBT receiver.  When connecting a device to the HDBT port, in some cases, RS-232 data may not pass from the connected device to the HDBT port. To fix and configure this, go to the Setting tab in the Data routing page and change Data Channel to 4 (see Setting the HDBT Port Data Routing Parameters on page 52).
16	HDMI IN Connectors	Connect to an HDMI source (IN 1 to IN 6).
17	PC IN 15-pin HD Connector	Connect to a VGA computer graphics source.
18	VIDEO INPUT Connectors (HDBT IN1 to HDBT IN4)	HDBT IN RJ-45 Connector Connect to an HDBT transmitter (IN 1 to IN 4).  When connecting a device to the HDBT port, in some cases, RS-232 data may not pass from the connected device to the HDBT port. To fix and configure this, go to the Setting tab in the Data routing page and change Data Channel to 4 (see Setting the HDBT Port Data Routing Parameters on page 52).
		IR (Rx, Tx) left 2-pins on a 5-pin Terminal Block Connectors Connect to the IR connector of an HDBT output (Tx to Rx and Rx to Tx), to tunnel IR data between an HDBT transmitter on the input and HDBT receiver on an output.
		RS-232 (G, Rx, Tx) right 3-pins on a 5-pin Terminal Block Connectors Connect to a serial controller or RS-232 controlled device for RS-232 link extension via the HDBT input (for HDBT IN 1 to IN 4).
19	EXT. CONTROL (G, Rx, Tx) 3-pin Terminal Block Connector	Connect to an external RS-232 device to be controlled (for example, a projector).
20	CONTROL (G, Rx, Tx) 3-pin Terminal Block Connector	Connect to a PC or remote controller to control VP-554X via Protocol 3000 commands. The port includes echoing when changes are made to the machine.

#	Feature	Function
②1	DATA RJ-45 Connector	Connect to a PC or other controller through computer networking. (Data 1 and Data 2). (All 4 ETH ports, ①4, ②1 and ②2 are connected to an internal Ethernet switch for convenience of connecting several network devices).
②2	CONTROL RJ-45 Connector	Connect to a PC or other controller through computer networking. (All 4 ETH ports, ①4, ②1 and ②2 are connected to an internal Ethernet switch for convenience of connecting several network devices).
②3	USB Type B IN Connectors	Connect to USB hosts (from 1 to 4).
②4	USB OUT Type A Connector	Connect to a USB client.
②5	DATA USB Type A Connector	For upgrading firmware.
②6	Mains Power Connector, Fuse and Switch	Connect to the mains supply.
②7	REMOTE MUTE 2-pin Terminal Block Connector	Remote switch to mute the audio signals. Enables easy integration of the audio system with PA systems, usually used for alarms or other public audio messages.
②8	MIC 3-pin Terminal block Connectors	Connect to microphones (Mic 1 and Mic 2).
②9	AUDIO IN 5-pin Terminal Block Connectors	Connect to stereo audio balanced sources (IN 1 to IN 8).
③0	AUDIO OUT 5-pin Terminal Block Connectors	Connect to stereo balanced audio acceptors (1 to 4 and Monitor Out).
③1	MONITOR OUT 5-pin Terminal Block Connector	Connect to a stereo balanced audio acceptor (for example, active speakers or an audio power amplifier).
③2	SPEAKER OUT 4-pin Terminal Block Connector	Connect to a pair of loudspeakers.

Mounting VP-554X

This section provides instructions for mounting **VP-554X**. Before installing, verify that the environment is within the recommended range:



- Operation temperature – 0° to 40°C (32 to 104°F).
- Storage temperature – -40° to +70°C (-40 to +158°F).
- Humidity – 10% to 90%, RHL non-condensing.

**Caution:**

- Mount **VP-554X** before connecting any cables or power.

**Warning:**

- Ensure that the environment (e.g., maximum ambient temperature & air flow) is compatible for the device.
- Avoid uneven mechanical loading.
- Appropriate consideration of equipment nameplate ratings should be used for avoiding overloading of the circuits.
- Reliable earthing of rack-mounted equipment should be maintained.

Mount VP-554X in a rack:

- Attach both rack ears by removing the screws from each side of the machine and replacing those screws through the rack ears.

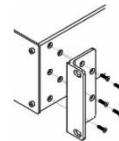

Connecting VP-554X

 Always switch off the power to each device before connecting it to your VP-554X. After connecting your VP-554X, connect its power and then switch on the power to each device.

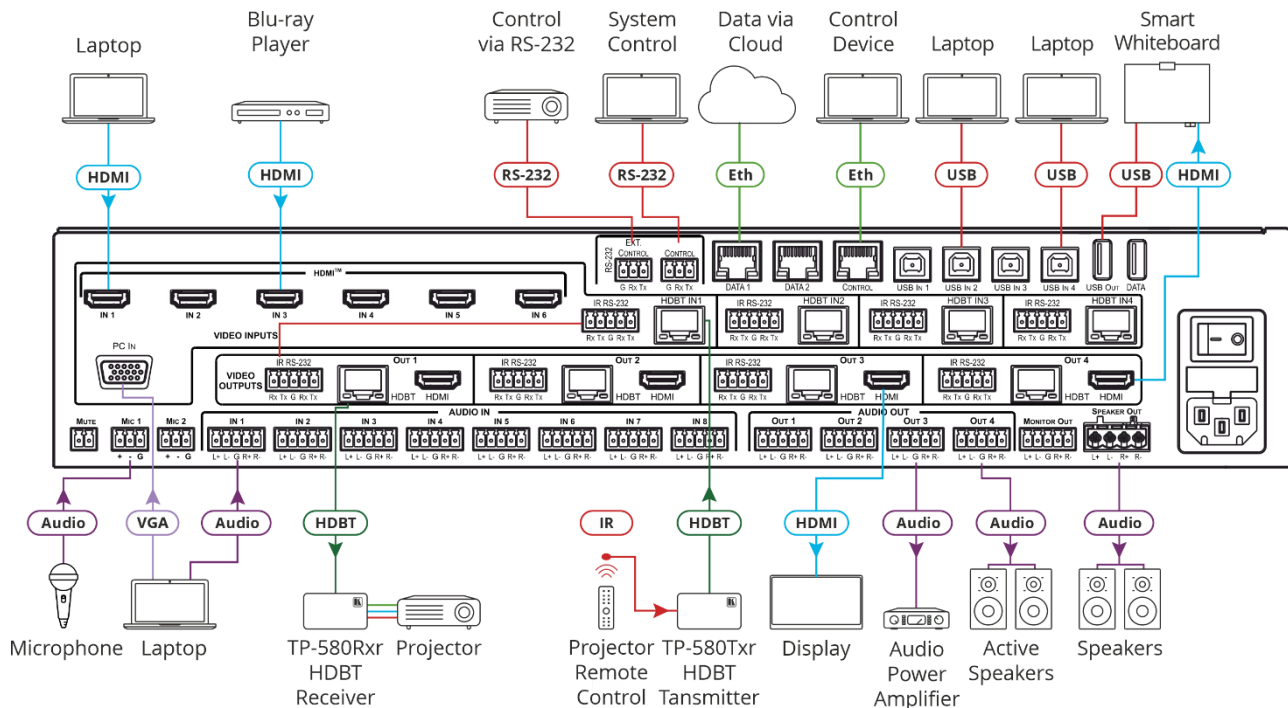

Figure 3: Connecting to the VP-554X Rear Panel

To connect VP-554X as illustrated in the example in [Figure 3](#):

1. Connect an HDMI source (for example, a Blu-ray player or laptop) to the HDMI IN connector **(16)** (from 1 to 6).
Alternatively, you can, for example, connect the DVI connector on a DVD player to the HDMI connector on the VP-554X via a DVI-HDMI adapter. When using this adapter, you can connect the audio signal via the terminal block connector
2. Connect a VGA source to the PC IN 15-pin HD connector **(17)**.
3. Connect an HDBT IN transmitter (for example, TP-580Txxr) to the HDBT IN RJ-45 connectors **(18)** (from 1 to 4).
4. Connect the USB IN ports **(23)** (from 1 to 4) (for example, laptops) and USB OUT port **(24)** (for example, a smart whiteboard).
5. Connect the audio inputs see [Connecting a Balanced/Unbalanced Stereo Audio Source to the Input](#) on page [11](#)) to:
 - The audio input 5-pin terminal block connectors **(29)** (from 1 to 8).
 - Up to 2 microphones to the MIC 3-pin terminal blocks **(28)** (1 to 2).

6. Connect OUT 1 to OUT 4:
 - OUT HDMI and/or HDBT output to an HDMI acceptor (for example a display / smart whiteboard) and/or an HDBT receiver (for example, **TP-580Rxr**).
7. Connect the audio outputs:
 - AUDIO OUT 5-pin terminal block connector (30) (1 to 4) to an analog stereo audio acceptor (for example, a power amplifier/active speakers).
 - MONITOR OUT line out 5-pin terminal block connector (30) to active speakers.
 - SPEAKER OUT (31) 4-pin terminal block connector to speakers.
Connect to a pair of loudspeakers, by connecting the left loudspeaker to the “L+” and the “L-” terminal block connectors, and the right loudspeaker to the “R+” and the “R-” terminal block connectors. **Do not Ground the loudspeakers.**
8. Connect the:
 - RS-232 EXT CONTROL 3-pin terminal block connector (19) port to an RS-232 controlled device to control it via commands sent from the **VP-554X**.
 - RS-232 CONTROL 3-pin terminal block connector (20) port to a PC to control the unit.
9. Connect the MUTE 2-pin terminal block contact-closure remote-control pins to a switch to mute/unmute the audio output by momentarily pressing the switch (not shown in [Figure 3](#)).
10. Connect the ETHERNET port (14) (on the front panel), DATA port (21) and/or CONTROL port (22) (on the rear panel), to the Network (see [Operating via Ethernet](#) on page 27).
11. Connect the power cord to the power socket.

Connecting the Output to a Balanced/Unbalanced Stereo Audio Acceptor

The following are the pinouts for connecting the output to a balanced or unbalanced stereo audio acceptor:

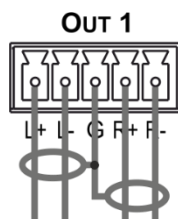

Figure 4: Connecting to a Balanced Stereo Audio Acceptor

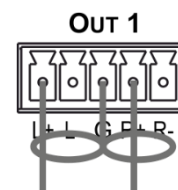

Figure 5: Connecting to an Unbalanced Stereo Audio Acceptor

Connecting a Balanced/Unbalanced Stereo Audio Source to the Input

The following are the pinouts for connecting a balanced or unbalanced stereo audio source to the balanced input:

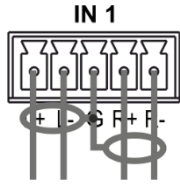

Figure 6: Connecting a Balanced Stereo Audio Source to the Balanced Input

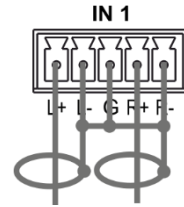

Figure 7: Connecting an Unbalanced Stereo Audio Source to the Balanced Input

Connecting to VP-554X via RS-232

You can connect to VP-554X via an RS-232 connection (13) using, for example, a PC.

VP-554X features an RS-232 3-pin terminal block connector allowing the RS-232 to control VP-554X.

Connect the RS-232 terminal block on the rear panel of VP-554X to a PC/controller, as follows:

From the RS-232 9-pin D-sub serial port, connect:

- Pin 2 to the TX pin on the VP-554X RS-232 terminal block
- Pin 3 to the RX pin on the VP-554X RS-232 terminal block
- Pin 5 to the G pin on the VP-554X RS-232 terminal block

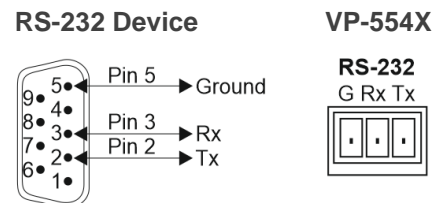

Wiring RJ-45 Connectors

This section defines the TP pinout, using a straight pin-to-pin cable with RJ-45 connectors.

 For HDBT cables, it is recommended that the cable ground shielding be connected/soldered to the connector shield.

EIA /TIA 568B	
PIN	Wire Color
1	Orange / White
2	Orange
3	Green / White
4	Blue
5	Blue / White
6	Green
7	Brown / White
8	Brown

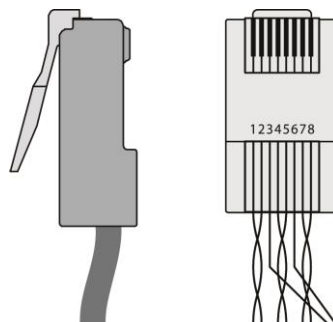

Operating and Controlling VP-554X

VP-554X front panel buttons enable performing the following actions:

- [Routing an input to an output](#) on page [12](#).
- [Routing a USB input to the USB output](#) on page [12](#).
- [Storing \(STO\) and Recalling \(RCL\) Outputs Via the Front Panel](#) on page [12](#).
- [Resetting the Resolution](#) on page [13](#).
- [Locking the Front Panel](#) on page [13](#).
- [Controlling Device Operation Via the OSD Menu](#) on page [13](#).
- [Operating via Ethernet](#) on page [27](#).

Routing an input to an output

To route an input to an output via the front panel:

1. Press an OUT button [②](#) (1 to 4).
2. Press an HDMI input [③](#) (1 to 6), an HDBT input [④](#) (1 to 4) or a PC IN [⑤](#) button.

Routing a USB input to the USB output

To route a USB input to the USB OUT port [⑳](#) via the front panel, press a USB button [①](#) next to “To USB OUT” on the front panel.

Storing (STO) and Recalling (RCL) Outputs Via the Front Panel

VP-554X enables storing and recalling the current device setup.

Storing the Current Configuration

To store the current configuration:

1. Set the required device configuration.
2. Press and hold **STO** [⑥](#) until button flashes once.

The current configuration is stored.

Recalling a Configuration

To recall the stored configuration:

- Press and hold **RCL**  until button flashes once.

The stored configuration is recalled.

Resetting the Resolution

To reset the resolution:

- Press and hold for about 2 seconds to set the output resolution to XGA (1024x768).
- Press and hold for about 5 seconds to set the output resolution to 1080p.



Setting the outputs to one of these common resolutions may be useful if **VP-554X** outputs at a resolution which the display cannot recognize, in which case, it is impossible to select a new resolution via the OSD menu.

Locking the Front Panel

To unlock/lock the front panel buttons:

- Press and hold for about 3 seconds to lock/unlock the front panel buttons.

Controlling Device Operation Via the OSD Menu

VP-554X enables controlling and defining the device parameters via the OSD, using the front panel MENU buttons.

Each OUTPUT OSD includes output specific features, such as selecting the source for the specific output, adjusting the image on the output, selecting the resolution and so on, as well as general features (such as OSD settings, factory reset and INFO).



Before accessing the OSD menu, you need to select the OSD for a specific output.

Accessing the OSD Menu

To enter and use the OSD menu buttons:

1. On the front panel button, press **OSD SELECT** to cycle through the outputs, to select the output to control via OSD (the OSD output). The LED lights next to the selected output.
2. Press **MENU**.

3. Press:
 - **ENTER** to accept changes and to change the menu settings.
 - **Arrow buttons** to move through the OSD menu, which is displayed on the video output.
 - **MENU** to go back to the previous menu list.



The default OSD timeout is set to 10 seconds.

Use the OSD menu to perform the following operations:

- [Accessing the OSD Menu](#) on page [13](#).
- [Selecting an Input Signal](#) on page [15](#).
- [Selecting the Image Size](#) on page [15](#).
- [Setting Output Resolution](#) on page [15](#).
- [Selecting Screen Color When No Signal Is Present](#) on page [16](#).
- [Setting Screen Freeze](#) on page [16](#).
- [Setting Screen Blank State](#) on page [17](#).
- [Adjusting PC Image Parameters](#) on page [17](#).
- [Adjusting the Image](#) on page [17](#).
- [Setting Audio Parameters](#) on page [18](#).
- [Setting Audio Output Monitor Out and Speaker Parameters](#) on page [20](#).
- [Adjusting the Input Volume](#) on page [21](#).
- [Defining Microphone Settings](#) on page [21](#).
- [Defining USB Settings](#) on page [21](#).
- [Setting OSD Parameters](#) on page [22](#).
- [Setting HDCP](#) on page [23](#).
- [Setting Sleep Mode](#) on page [23](#).
- [Setting Switching Mode](#) on page [24](#).
- [Accessing the Video Wall mode](#) on page [24](#).
- [Managing EDID via OSD](#) on page [24](#).
- [Defining Daily Reset Time](#) on page [25](#).
- [Setting the HDBT Input Range](#) on page [26](#).
- [Viewing Device Information](#) on page [26](#).
- [Performing a Reset](#) on page [26](#).
- [Defining Network Parameters](#) on page [27](#).

Selecting an Input Signal

Select the **VP-554X** input source for the selected OSD output.

To set the input source:

1. On the front panel press **MENU**. The menu appears.
2. Select **VIDEO** then select **SOURCE**.
3. Press **ENTER** and select HDMI (1 to 6), HDBT (1 to 4) or PC.
4. Press **ENTER**.

An input signal is selected.

Selecting the Image Size

Set the image size on the selected OSD output.

To set the image size:

1. On the front panel press **MENU**. The menu appears.
2. Select **VIDEO** then select **SIZE**.
3. Press **ENTER** and select FULL, BEST FIT, PAN SCAN, LETTER BOX, UNDER 2, UNDER 1, FOLLOW IN or OVER SCAN.
4. Press **ENTER**.

The image size is selected.

Setting Output Resolution

VP-554X enables setting the resolution on the selected OSD output via the OSD MENU buttons.



The resolution is set only for the output that is selected (via the front panel OSD SELECT button) to show the OSD.

To set the output resolution:

1. On the front panel press **MENU**. The menu appears.
2. Select **VIDEO**, then select **OUTPUT** to define the output resolution.

Menu Item	Function			
Resolution	Select the output resolution (default, NATIVE):			
	640x480 @60Hz	1600x1200 @60Hz	3440x1440 @30Hz RB	1920x1080P @25Hz
	800x600 @60Hz	1680x1050 @60Hz	3440x1440 @60Hz RB	1920x1080P @30Hz
	1024x768 @60Hz	1920x1200 @60Hz RB	720x480P @60Hz	2560x1080P @50Hz
	1280x768 @60Hz	2560x1600 @60Hz RB	1280x720P @60Hz	2560x1080P @60Hz
	1280x800 @60Hz	1920x1080 @60Hz	1920x1080P @60Hz	3840x2160P @24Hz
	1280x1024 @60Hz	1280x720 @60Hz	720x576P @50Hz	3840x2160P @25Hz
	1360x768 @60Hz	2048x1080 @50Hz	1280x720P @50Hz	3840x2160P @30Hz
	1400x1050 @60Hz	2048x1080 @60Hz	1920x1080P @50Hz	3840x2160P @50Hz
	1440x900 @60Hz	2560x1440 @60Hz RB	1920x1080P @24Hz	3840x2160P @60Hz

3. Press **ENTER**.

Output parameters are defined.



To recover if the unit outputs at a resolution which cannot be displayed, press and hold the front-panel RESET TO XGA/1080P button.

Selecting Screen Color When No Signal Is Present

Select the **VP-554X** screen color on the selected OSD output when no signal is detected on that output.

To set the no-signal screen color:

1. On the front panel press **MENU**. The menu appears.
2. Select **VIDEO**, then select **NO SIGNAL COLOR**.
3. Press **ENTER** and select **BLACK, WHITE, BLUE, RED** or **GREEN**.
4. Press **ENTER**.

The No Signal screen color is selected.

Setting Screen Freeze

Select the **VP-554X** screen freeze state.

To set the no-signal screen color:

1. On the front panel press **MENU**. The menu appears.
2. Select **VIDEO**, then select **FREEZE**.
3. Press **ENTER** and select **ON** or **OFF**.
4. Press **ENTER**.

The screen freeze state is set.

Setting Screen Blank State

Select the **VP-554X** screen freeze state.

To set the blank screen state:

1. On the front panel press **MENU**. The menu appears.
2. Select **VIDEO**, then select **BLANK**.
3. Press **ENTER** and select **blank (5v low)**, **blank** or **OFF**.
4. Press **ENTER**.

The screen freeze state is set.

Adjusting PC Image Parameters

VP-554X enables adjusting the VGA position and synchronization parameters.

To adjust the PC parameters:

1. On the front panel press **MENU**. The menu appears.
2. Click **VIDEO** then select **PC SETUP**.

Menu Item	Function
AUTO SETUP	auto adjusts the image (centers it correctly on the screen) every time the input is switched to VGA or when the input resolution changes. PC setup messages appear as follows: INCOMPLETE , COMPLETE or EXECUTING .
PC H-POSITION	Set the horizontal position of the picture.
PC V-POSITION	Set the vertical position of the picture.
PC PHASE	Set the clock phase.
PC CLOCK	Set the clock frequency.
RESET	Reset settings to their default values.
PC MODE	Select PC resolution mode.

PC parameters are adjusted.

Adjusting the Image

VP-554X enables adjusting the selected OSD output image parameters such as contrast, brightness and so on.

To adjust the image parameters:

1. On the front panel press **MENU**. The menu appears.
2. Click **PICTURE**.

3. Click a menu item as described in the following table:

Menu Item	Function
COLOR GAIN for R, G and B	Set the Red, Green and Blue shades.
COLOR OFFSET for R, G and B	Set the color offset level for red, green and blue.
Brightness	Set the brightness.
Contrast	Set the contrast.
HUE	Set the color hue.
SATURATION	Set the color saturation.
SHARPNESS	Set the sharpness of the picture.
NR (Noise Reduction)	Select the noise reduction filter: Off (default), Low, Middle or High.
RESET PICTURE	Reset image parameters to their default value.

Image parameters are adjusted.

Setting Audio Parameters

VP-554X enables defining the audio parameters for the selected OSD output.

To set the audio parameters:

1. On the front panel press **MENU**. The menu appears.
2. Select **AUDIO**.
3. Select an audio parameter from the list below and adjust as needed.
4. For each adjusted parameter, press **ENTER**.

Menu Item	Function						
SOURCE	Select any of the following audio sources: HDMI (1 to 6), HDBT (1to 4), ANALOG (1 to 8), MIC1, MIC2, MIC 1+2, FOLLOW VIDEO (default).						
EMBEDDED	<table border="1"> <tr> <td>HDMI (1 to 6)</td> <td>Select EMBEDDED, ANALOG, or AUTOMATIC (default).</td> </tr> <tr> <td>HDBT (1 to 4)</td> <td>EMBEDDED selects the embedded HDMI audio source; ANALOG selects the analog audio corresponding to the input; and AUTOMATIC (default) selects the embedded audio when an HDMI source is detected, or the analog audio when a DVI input is detected.</td> </tr> </table>	HDMI (1 to 6)	Select EMBEDDED, ANALOG, or AUTOMATIC (default).	HDBT (1 to 4)	EMBEDDED selects the embedded HDMI audio source; ANALOG selects the analog audio corresponding to the input; and AUTOMATIC (default) selects the embedded audio when an HDMI source is detected, or the analog audio when a DVI input is detected.		
HDMI (1 to 6)	Select EMBEDDED, ANALOG, or AUTOMATIC (default).						
HDBT (1 to 4)	EMBEDDED selects the embedded HDMI audio source; ANALOG selects the analog audio corresponding to the input; and AUTOMATIC (default) selects the embedded audio when an HDMI source is detected, or the analog audio when a DVI input is detected.						
AUDIO MAPPING	<table border="1"> <tr> <td>HDMI (1 to 6)</td> <td>When the EMBEDDED menu is assigned to ANALOG (or AUTOMATIC, if a DVI source is connected).</td> </tr> <tr> <td>HDBT (1 to 4)</td> <td>Select NONE (default) for no analog signal to be assigned to the selected source, or select an analog source (ANALOG 1 to ANALOG 8) to assign to a video source:</td> </tr> <tr> <td>PC</td> <td>After selecting an analog source, that specific source is unavailable for a different source. For example, if HDMI 1 Mapping is ANALOG 7, ANALOG 7 will not be available for the other inputs for mapping.</td> </tr> </table>	HDMI (1 to 6)	When the EMBEDDED menu is assigned to ANALOG (or AUTOMATIC, if a DVI source is connected).	HDBT (1 to 4)	Select NONE (default) for no analog signal to be assigned to the selected source, or select an analog source (ANALOG 1 to ANALOG 8) to assign to a video source:	PC	After selecting an analog source, that specific source is unavailable for a different source. For example, if HDMI 1 Mapping is ANALOG 7, ANALOG 7 will not be available for the other inputs for mapping.
HDMI (1 to 6)	When the EMBEDDED menu is assigned to ANALOG (or AUTOMATIC, if a DVI source is connected).						
HDBT (1 to 4)	Select NONE (default) for no analog signal to be assigned to the selected source, or select an analog source (ANALOG 1 to ANALOG 8) to assign to a video source:						
PC	After selecting an analog source, that specific source is unavailable for a different source. For example, if HDMI 1 Mapping is ANALOG 7, ANALOG 7 will not be available for the other inputs for mapping.						
AUDIO BYPASS	Select ON to “bypass” an embedded audio input to the output (for example, to support multi-channel, compressed audio formats, Dolby, DTS, etc.). (Default, OFF)						
HDMI VOLUME	Set the HDMI output volume. 0 to 100 (Default: 80).						
LINE VOLUME	Set the analog audio volume. 0 to 100 (Default: 80).						
HDMI HARDSTOP	Set HDMI volume hard stop. 0~100 (Default: 80). (Use this feature to limit the maximum HDMI output volume level).						

Menu Item	Function
LINE HARDSTOP	Set the analog audio hard stop. 0~100 (Default: 80). (Use this feature to limit the maximum analog output volume level).
HDMI MUTE	Mute the HDMI audio. OFF/ ON (Default: OFF).
LINE MUTE	Mute the analog audio. OFF/ ON (Default: OFF).
MUTE FOLLOW	OFF/ BLANK/FREEZE/BLANK+FREEZE (Default: OFF).
AUDIO DELAY	OFF/ 10ms/ 20ms/ 30ms/ 40ms/ 50ms (Default: OFF).
MIXER MODE	OFF/ MIXER/ TALKOVER (Default: OFF).
MIXER LEVEL	0~100 (Default: 100).
TALKOVER	When Mic Mode is set to Talkover (see Talkover Mode on page 19), set the following:
Depth [%]	Set the depth value to determine the decrease of the audio level during microphone takeover (press + to further decrease the talkover audio output level; press – to lessen the talkover output audio decrease level).
Trigger [dB]	Set the trigger value to determine the microphone threshold level that triggers the audio output level decrease.
Attack Time	Set the attack time to set the transition time of the audio level reduction after the signal rises above the threshold level.
Hold Time	Set the hold time to define the time-period talkover remains active although the signal falls below the threshold level (for a short period of time).
Release Time	Set the release time to define the transition time for the audio level to return from its reduced level to its normal level after the Hold Time period.
EQ	Set the Audio equalization: EQ 120Hz, 200Hz, 500Hz, 1200Hz, 3000Hz, 7500Hz, 12000Hz or reset to default value.
RESET AUDIO	Select to reset all the audio parameters to their default values.

5. Press **ENTER**.

Audio parameters are defined.

Talkover Mode

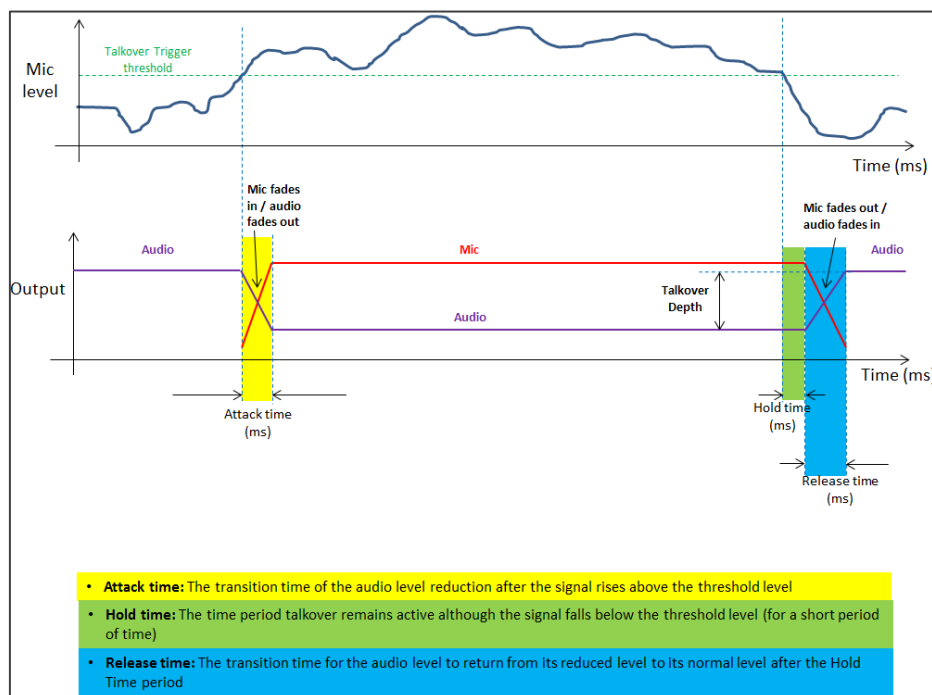

Figure 8: Talkover Mode

Setting Audio Output Monitor Out and Speaker Parameters

VP-554X enables defining the monitor output and speaker parameters.



The AUDIO OUTPUT menu appears in the OSD output 1 menu only.

To set the audio parameters:

1. On the front panel press **MENU**. The menu appears.
2. Select **ADVANCED** and then **AUDIO**.
3. Select an audio parameter from the list below and adjust as needed.
4. For each adjusted parameter, press **ENTER**.

Menu Item		Function
SOURCE		Select any of the following audio sources: HDMI (1 to 6), HDBT (1 to 4), ANALOG (1 to 8), MIC1, MIC2, MIC 1+2, FOLLOW VIDEO (default).
EMBEDDED	HDMI (1 to 6)	Select EMBEDDED, ANALOG, or AUTOMATIC (default). EMBEDDED selects the embedded HDMI audio source; ANALOG selects the analog audio corresponding to the input; and AUTOMATIC (default) selects the embedded audio when an HDMI source is detected, or the analog audio when a DVI input is detected.
	HDBT (1 to 4)	
SPEAKER VOLUME		Set the Speaker output volume. 0 to 100 (Default: 80).
LINE VOLUME		Set the monitor line volume. 0 to 100 (Default: 80).
SPEAKER HARDSTOP		Set speaker volume hard stop. (Use this feature to limit the maximum speaker volume level). 0~100 (Default: 80).
LINE HARDSTOP		Set the monitor hard stop. (Use this feature to limit the maximum volume level on the line output). 0~100 (Default: 80).
SPEAKER MUTE		Mute the speaker audio. OFF/ ON (Default: OFF).
LINE MUTE		Mute the monitor audio. OFF/ ON (Default: OFF).
AUDIO DELAY		OFF/ 10ms/ 20ms/ 30ms/ 40ms/ 50ms (Default: OFF).
MIXER MODE		OFF/ MIXER/ TALKOVER (Default: OFF).
MIXER LEVEL		0~100 (Default: 100).
TALKOVER		When Mic Mode is set to Talkover (see Talkover Mode on page 19), set the following:
	Depth [%]	Set the depth value to determine the decrease of the audio level during microphone takeover (press + to further decrease the talkover audio output level; press – to lessen the talkover output audio decrease level).
	Trigger [dB]	Set the trigger value to determine the microphone threshold level that triggers the audio output level decrease.
	Attack Time	Set the attack time to set the transition time of the audio level reduction after the signal rises above the threshold level.
	Hold Time	Set the hold time to define the time-period talkover remains active although the signal falls below the threshold level (for a short period of time).
	Release Time	Set the release time to define the transition time for the audio level to return from its reduced level to its normal level after the Hold Time period.

Menu Item	Function
EQ	Set the Audio equalization: EQ 120Hz, 200Hz, 500Hz, 1200Hz, 3000Hz, 7500Hz, 12000Hz or reset to default value.

5. Press **ENTER**.

Audio parameters are defined.

Adjusting the Input Volume

Set the input volume levels for each HDMI, HDBT and Analog Audio input.



The INPUT VOLUME menu appears in the OSD output 1 menu only.

To adjust an input volume:

1. On the front panel press **MENU**. The menu appears.
2. Select **ADVANCED** and then **INPUT VOLUME**.
3. Select an input audio port (**HDMI**, **HDBT** or **AUDIO**).
4. Press **ENTER**.
5. Adjust the volume.
6. Press **ENTER**.

The input volume is adjusted.

Defining Microphone Settings

Define the following microphone settings.



The MIC SETTING menu appears in the OSD output 1 menu only.

To define microphone settings:

1. On the front panel press **MENU**. The menu appears.
2. Click **ADVANCED** and select **MIC SETTING**.
3. Adjust the gain for each of the microphones and set the microphone type.
4. Press **ENTER**. For each parameter.

Microphone settings are defined.

Defining USB Settings

The **VP-554X** incorporates a simple, yet effective, 4:1 USB switcher. The switcher can be used, for example, to connect one out of several PCs to a smart board or other USB client.

The USB switcher can be routed as a separate layer, or can be tied to the video switching layer of the unit. This creates a powerful “USB follows video” system – the PC routed to the

display also connects to the smart board. In many meeting room setups these USB switching schemes are highly effective.



The USB SETTING menu appears in OSD output 1 menu only.

To define USB settings:

1. On the front panel press **MENU**. The menu appears.
2. Click **ADVANCED** and select **USB SETTING**.
3. Select the USB source.
4. Set the input for the USB port to follow.

Parameter	Function
SOURCE	Select the USB input: USB 1, USB 2, USB 3, USB 4 or TIE TO INPUT.
SETUP FOLLOW INPUT	If TIE TO INPUT was selected above, setup the input to which the selected USB port will be tied. For each of the inputs you can select a USB port (1 to 4) that will follow (HDMI123456 / HDBT1234 / PC). For example, if you want to set USB 3 to follow HDMI 3, select HDMI 3 and set to USB 3.

5. Press **ENTER**. For each parameter.

USB settings are defined.

Setting OSD Parameters

VP-554X enables adjusting the position, timing and display of the OSD menu for your convenience.

To set the OSD parameters:

1. On the front panel press **MENU**. The menu appears.
2. Click **OSD** and define the OSD's parameters according to the information in the following table:

Menu Item	Function
H-POSITION	Set the horizontal position of the OSD.
V-POSITION	Set the vertical position of the OSD.
TIMER	Set the timeout period to Off or up to 60 seconds (default 10).
TRANSPARENCY	Set the OSD background between 100 (transparent) and 0 (opaque).
DISPLAY	Select the information displayed on-screen during operation: Info (default) – Information appears for 10 seconds. On – Information appears constantly. Off – Information does not appear.
RESET OSD	Select to reset the OSD parameters to their default values.

OSD parameters are set.

Setting HDCP

VP-554X enables setting the HDCP on the outputs and on the inputs the via the front panel MENU buttons.



The HDCP is set only for the output that is selected (via the front panel OSD SELECT button) to show the OSD and for the selected input.

To set the HDCP on the inputs and outputs:

1. On the front panel press **MENU**. The menu appears.
2. Click **ADVANCED** and define the HDCP parameters according to the information in the following table:

Menu Item	Function
HDCP ON OUTPUT	Select FOLLOW OUTPUT (default) or FOLLOW INPUT on HDMI OUT. Select FOLLOW OUTPUT (recommended) for the scaler to match its HDCP output to the HDCP setting of the acceptor to which it is connected. Select FOLLOW INPUT to change its HDCP output setting according to the HDCP of the input (recommended when the output is connected to a splitter/switcher).
INPUT HDCP	Set HDCP support ON (default) or OFF. Note that: <ol style="list-style-type: none"> 1. HDCP must be enabled (ON) to support HDCP encrypted sources. 2. Sources such as Mac computers always encrypt their outputs when detecting that the sink supports HDCP. If the content does not require HDCP, you can prevent these sources from encrypting by disabling (OFF) HDCP on the input.

3. Press ENTER.

HDCP is set on the input/output.

Setting Sleep Mode

Auto Sync Off turns off the output after a period of not detecting a valid video signal on the input(s) until a valid input is again detected or any keypad button is pressed.

VP-554X enables configuring the Auto Sync Off delay time when a connected display enters sleep mode.

To set Auto Sync Off:

1. On the front panel press **MENU**. The menu appears.
2. Click **ADVANCED** and select **AUTO SYNC OFF**.
3. Define Auto Sync Off according to the information in the following table:

Menu Item	Function
Disable	Leave outputs active always.
FAST (10s)	Disable outputs after ~ 10 seconds of no input detection.
SLOW (120s)	Disable outputs after ~ 2 minutes of no input detection.
IMMEDIATE	Disable outputs immediately when there is no input detection.

4. Press **ENTER**.

Sleep mode is defined.

Setting Switching Mode

VP-554X enables configuring for automatic switching of the input source upon signal loss or when a source is plugged in:

- Off – Set to manual switching.
- Auto Scan – Set to auto-scan the inputs when no input source is detected.
- Last connected – When detecting that a source is connected to an input (which previously had no signal), automatically switch to that input.

To set the switching mode:

1. On the front panel press **MENU**. The menu appears.
2. Click **ADVANCED** and select **AUTO SWITCH**.
3. Click **ENTER** and select **AUTO SCAN**, **LAST CONNECTED** or **OFF**.
4. Press **ENTER**.

Switching mode is defined.

Accessing the Video Wall mode

VP-554X can be configured as a 2x2 video wall.

To access the video wall mode:

1. On the front panel press **MENU**. The menu appears.
2. Click **ADVANCED** and select **VIDEO WALL**.
3. Click **ENTER** and select **ON** or **OFF**.
4. Press **ENTER**.

VP-554X is set to video wall mode.

Managing EDID via OSD

VP-554X enables managing the EDID via the OSD menu buttons.



The EDID menu appears in the OSD output 1 menu only.

To manage the EDID:

1. On the front panel press **MENU**. The menu appears.
2. Click **ADVANCED**, select **EDID**.
3. Press **ENTER** and define the EDID parameters according to the information in the following table:

Menu Item	Function
HDMI EDID (1 to 6)	For the HDMI input, select a built-in EDID file and press enter: Def. 4K6G (MCH) default, OUTPUT HDMI1, OUTPUT HDBT1, OUTPUT HDMI2, OUTPUT HDBT2, OUTPUT HDMI3, OUTPUT HDBT3, OUTPUT HDMI4, OUTPUT HDBT4, USER EDID, Def.1080P (2CH), Def. 1080P (MCH), Def. 4K3G(2CH), Def. 4K3G(MCH), Def. 4K6G (2CH).
HDBT EDID (1 to 4)	For the HDBT input, select a built-in EDID file and press enter: Def. 4K3G (MCH) default, Def. 4K6G (2CH), Def. 4K6G(MCH), OUTPUT HDMI1, OUTPUT HDBT1, OUTPUT HDMI2, OUTPUT HDBT2, OUTPUT HDMI3, OUTPUT HDBT3, OUTPUT HDMI4, OUTPUT HDBT4, USER EDID, Def.1080P (2CH), Def. 1080P (MCH), Def. 4K3G(2CH).
PC EDID	Default EDID or USER EDID.

The selected EDID file is saved on the selected input.

Uploading EDID from an External File**To select the EDID from an external file:**

1. Upload the EDID file to a memory stick.
The EDID file name should be USER_EDID1.bin or USER_EDID2.bin
2. On the front panel press **MENU**. The OSD menu appears.
3. Click **ADVANCED** and select **EDID**.
4. Select **USER EDID**.
5. Press **ENTER**.

The external EDID file is saved to the device.

Defining Daily Reset Time

VP-554X enables defining a daily switching time.



The DAILY RESET menu appears in OSD output 1 menu only.

To set the switching mode:

1. On the front panel press **MENU**. The menu appears.
2. Click **ADVANCED** and select **DAILY RESET**.
3. Click **ENTER**.
4. Select **ON** to enable a daily reset.
5. Set the hours (24) and minutes (60).

6. Define the power up setup: **DISABLE**, **RESTART** or **RESUME**.

7. Press **ENTER**.

Daily reset time is defined.

Setting the HDBT Input Range

You can set each of the HDBT inputs to long-reach mode.



The HDBT LONG REACH menu appears in the OSD output 1 menu only.

To set an input to the long reach mode:

1. On the front panel press **MENU**. The menu appears.
2. Click **ADVANCED** and select **HDBT LONG REACH**.
3. Click **ENTER** and select **ON/OFF** for the desired input.
4. Press **ENTER**.

HDBT input range is defined.

Viewing Device Information

Device information includes the selected source, the input and output resolutions, the HDCP status and the software version.

To view the information:

1. On the front panel press **MENU**. The menu appears.
2. Click **INFORMATION**.
3. View the information.

Information appears and is viewed.

Performing a Reset

VP-554X enables performing a soft reset and a full factory reset via the front panel **MENU** buttons.

To reset the device:

1. On the front panel press **MENU**. The menu appears.
2. Click **RESET** and select **RESET** (to reset all the parameters excluding Network parameters) or **RESET ALL**.

Wait for completion of factory reset (resolution is set to Native).

Device is reset.

Defining Network Parameters

Define the Network parameters via the OSD menu.



The ETHERNET menu appears in OSD output 1 menu only.

To define Network settings:

1. On the front panel press **MENU**. The menu appears.
2. Click **ETHERNET** and select the parameters in the following table:

Parameter	Function
IP MODE	Set the IP mode to DHCP or STATIC IP.
SET STATIC IP	Enter STATIC IP ADDRESS details when STATIC IP (above) is selected: STATIC IP, MASK and GATE.
UDP PORT	Set the port number.
TCP PORT	Set the port number.
IP	Displays the IP address.
MAC	Displays the MAC address.

3. Click **ENTER** for each.

Network parameters are set.

Operating via Ethernet

You can connect to **VP-554X** via Ethernet using either of the following methods:

- Directly to the PC using a crossover cable (see [Connecting Ethernet Port Directly to a PC](#) on page 27).
- Via a network hub, switch, or router, using a straight-through cable (see [Connecting Ethernet Port via a Network Hub](#) on page 29).

Note: If you want to connect via a router and your IT system is based on IPv6, speak to your IT department for specific installation instructions.

Connecting Ethernet Port Directly to a PC

You can connect the Ethernet port of **VP-554X** directly to the Ethernet port on your PC using a crossover cable with RJ-45 connectors.



This type of connection is recommended for identifying **VP-554X** with the factory configured default IP address.

After connecting **VP-554X** to the Ethernet port, configure your PC as follows:

1. Click **Start > Control Panel > Network and Sharing Center**.
2. Click **Change Adapter Settings**.

- Highlight the network adapter you want to use to connect to the device and click **Change settings of this connection**.

The Local Area Connection Properties window for the selected network adapter appears as shown in [Figure 9](#).

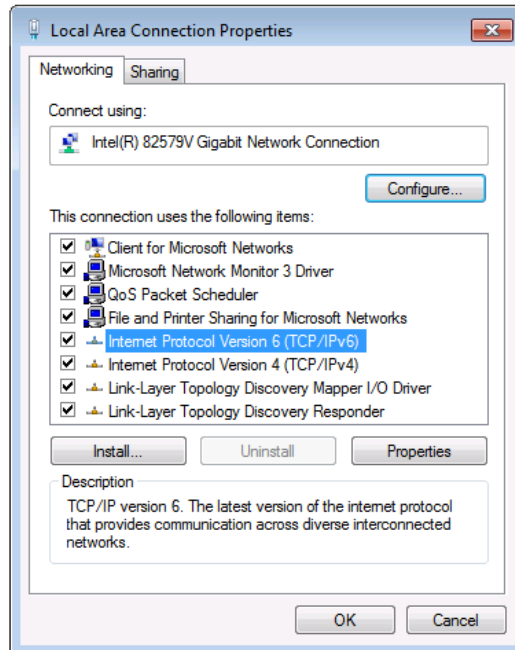

Figure 9: Local Area Connection Properties Window

- Highlight either **Internet Protocol Version 6 (TCP/IPv6)** or **Internet Protocol Version 4 (TCP/IPv4)** depending on the requirements of your IT system.
- Click **Properties**.

The Internet Protocol Properties window relevant to your IT system appears as shown in [Figure 10](#) or [Figure 11](#).

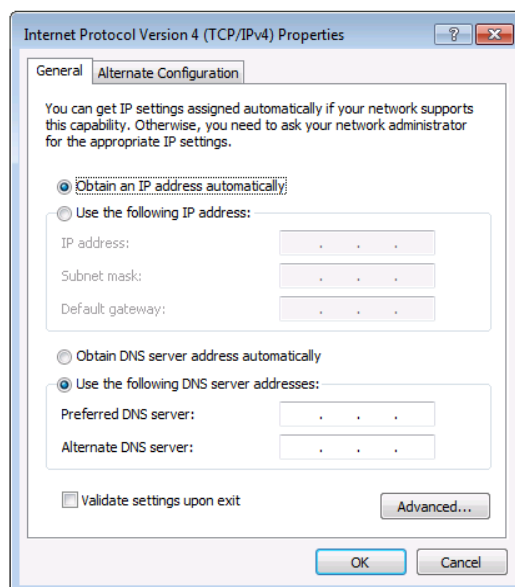

Figure 10: Internet Protocol Version 4 Properties Window

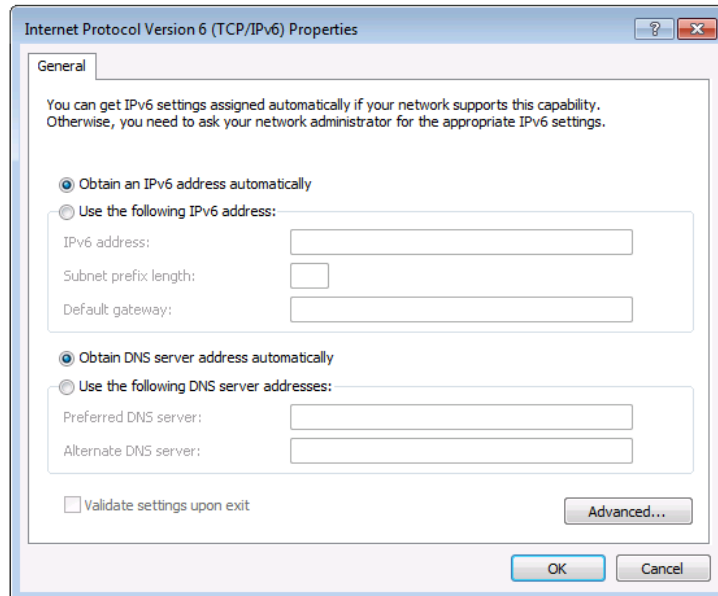

Figure 11: Internet Protocol Version 6 Properties Window

6. Select **Use the following IP Address** for static IP addressing and fill in the details as shown in [Figure 12](#).

For TCP/IPv4 you can use any IP address in the range 192.168.1.1 to 192.168.1.255 (excluding 192.168.1.39) that is provided by your IT department.

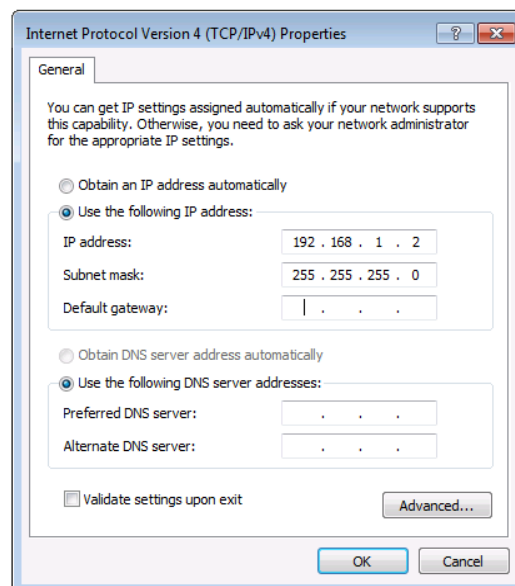

Figure 12: Internet Protocol Properties Window

7. Click **OK**.
8. Click **Close**.

Connecting Ethernet Port via a Network Hub or Switch

You can connect the Ethernet port of VP-554X to the Ethernet port on a network hub or using a straight-through cable with RJ-45 connectors.

Configuring Ethernet Port

You can set the Ethernet parameters via the embedded Web pages.

Using Embedded Web pages

The web pages enable you to control **VP-554X** via the Ethernet. The web pages include all the OSD items and are accessed using a Web browser and an Ethernet connection.

Browsing Web Pages

Before attempting to connect:

- Perform the procedures described in (see [Operating via Ethernet on page 27](#)).
- Ensure that your browser is supported.

The following operating systems and Web browsers are supported:

Operating Systems	Browser
Windows 7	IE
	Firefox
	Chrome
	Safari
Windows 10	IE
	Edge
	Firefox
	Chrome
Mac	Safari
iOS	Safari
Android	N/A

To browse the VP-554X web pages:

- 1. Open your Internet browser.
- 2. Type the IP address of the device in the address bar of your browser. For example, the default IP address:



The Authentication window appears (if set, security is enabled):

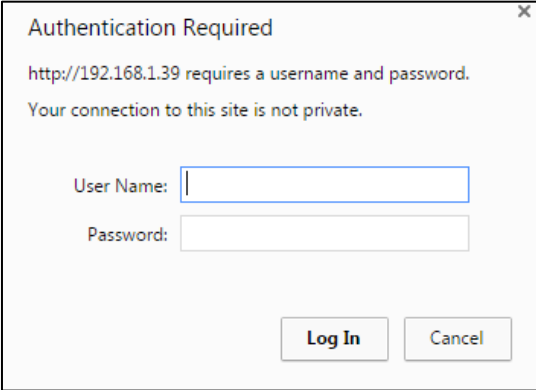

Figure 13: Using the Embedded Web pages – Authentication

- 3. Enter the **User Name** and **Password** (admin, admin) and click **OK**. The Switching page appears:

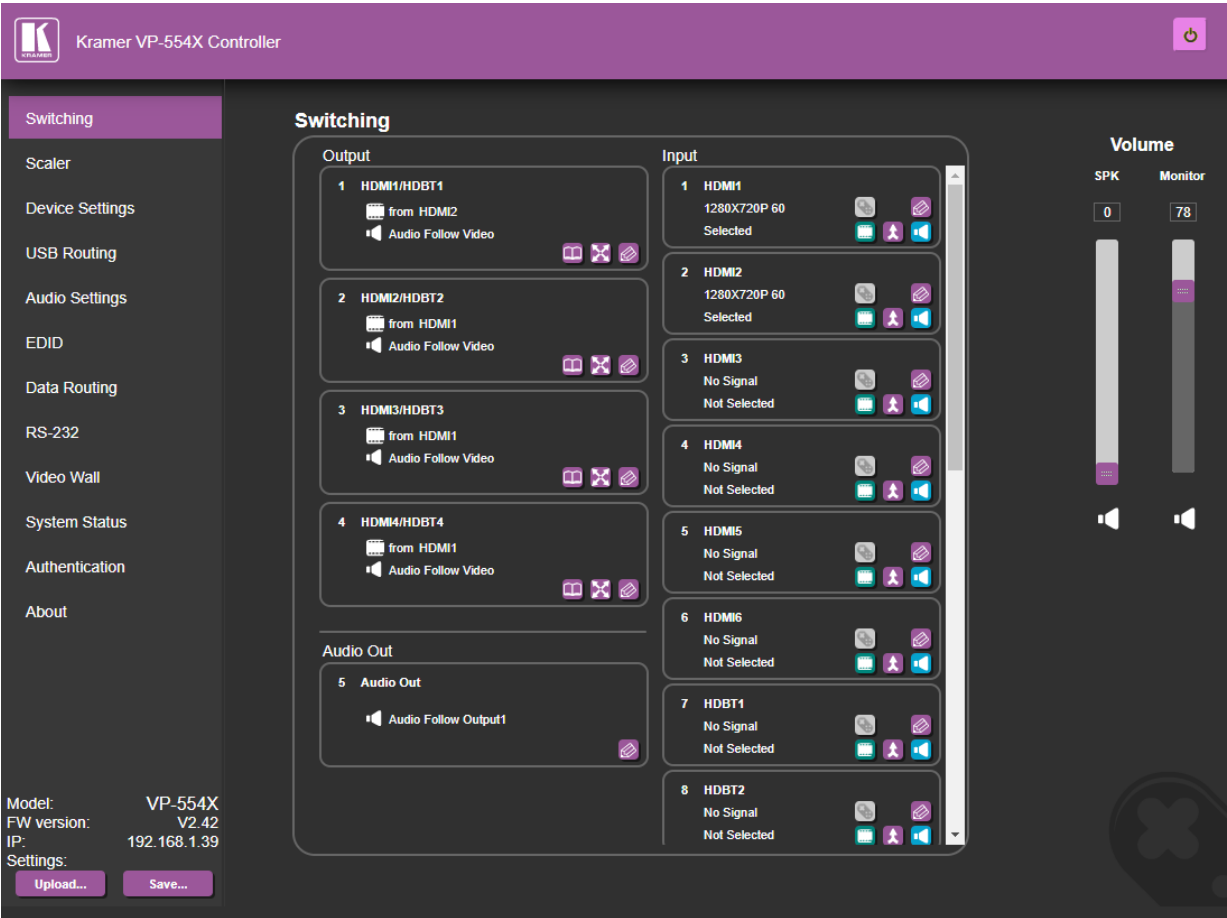

Figure 14: Switching Page with Navigation List on Left

- 4. Click the desired web page or click the arrow to hide the navigation list.

Switching and Setting Ports

The Switching web page enables performing the following functions:

- [Viewing and Adjusting Output Settings](#) on page [32](#).
- [Viewing and Adjusting Input Settings](#) on page [34](#).
- [Adjusting and Muting the Speaker and Monitor Audio](#) on page [36](#).
- [Switching an Input to an Output](#) on page [36](#).
- [Using VP-554X with a “Step-in” Device](#) on page [37](#).

Viewing and Adjusting Output Settings

You can view the status of the outputs and adjust their settings via the output buttons.

To view and adjust output settings:

1. In the Navigation pane, click **Switching**. The Switching page appears ([Figure 14](#)).

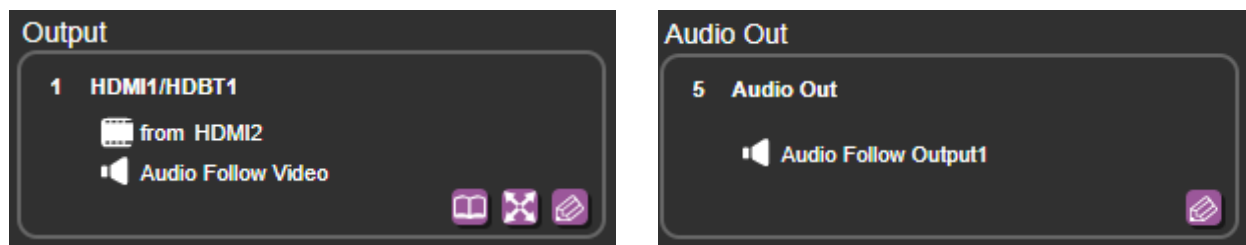





Figure 15: Switching Page – Output Buttons

2. View the following:
 - The name (in this example, the name is HDMI1/HDBT1 for the video output and Audio Out for the audio output).
 - The input source (in this example, video input HDMI2 is the source).
 - Audio status for the video output is Audio Follow Video, and Audio Follow Output1 for the audio output.
3. Perform the following actions:
 - Click  to access the EDID page and read the EDID.
 - Click  to access the Scaler page and define image parameters.
 - Click  to open the video output Edit settings window (see [Defining Video Output Settings](#) on page [33](#)) and the audio output settings page (see [Defining Audio Monitor and Speaker Output Settings](#) on page [34](#)).

Defining Video Output Settings

Define the video output settings.

To define the video output settings:

1. In the Navigation pane, click **Switching**. The Switching page appears ([Figure 14](#)).
2. Click  on the output button to open the output settings window.

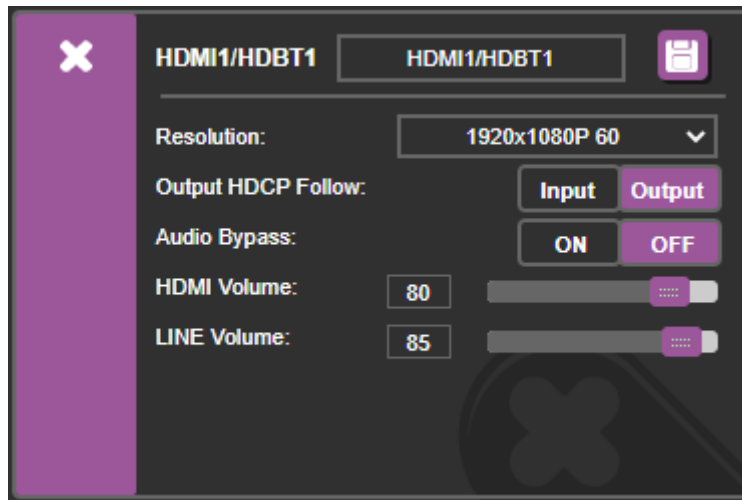



Figure 16: Video Output Settings

3. Perform the following actions:
 - Change the output label name (up to 16 characters) and click .
 - Select the video output resolution from the drop-down box.
 - Define output HDCP Follows Input/Output.
 - Set the HDMI audio output volume.
 - Set the Analog Audio output volume.
4. Click **X** to close the window.

Video settings are defined

Defining Audio Monitor and Speaker Output Settings

Define the monitor and speaker audio output settings.

To define the audio output settings:

1. In the Navigation pane, click **Switching**. The Switching page appears ([Figure 14](#)).
2. Click  on the audio out button to open the Audio Out settings window.

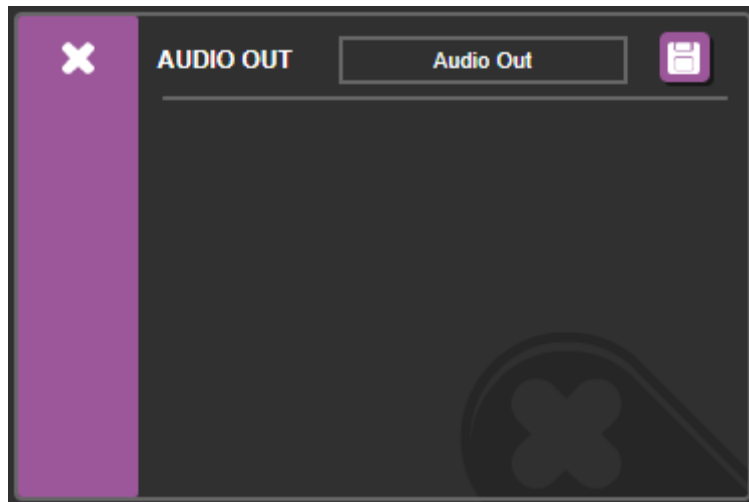



Figure 17: Audio Output Settings

3. Change the output label (up to 16 characters) name and click .
4. Click **X** to close the window.

Monitor and speaker audio settings are defined.

Viewing and Adjusting Input Settings

VP-554X inputs include 6 HDMI and 4 HDBT inputs, 1 PC input, 8 analog audio inputs, 2 Mic inputs and 1 Mic 1+2 mix input. View the status of the inputs and adjust their settings via the input buttons.

To view and adjust input settings:

1. In the Navigation pane, click **Switching**. The Switching page appears ([Figure 14](#)).

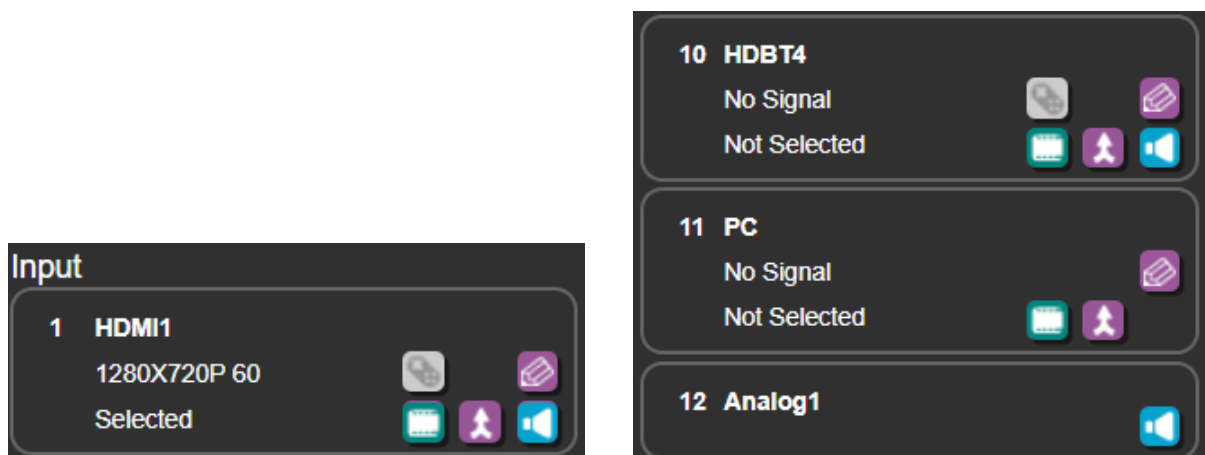







Figure 18: Switching Page – Input Button

2. View the following:
 - The name (in this example, the name is HDMI1 for the video input).
 - The resolution (in this example, the resolution is 1280x720P@60Hz).
 - Video input status (Selected or Not Selected).
3. Perform the following actions:
 - Click  to access the Step-in remote control setup window (see [Using VP-554X with a “Step-in” Device](#) on page 37).
 - Click  to open the video input Edit settings window (see [Defining Video Input Settings](#) on page 35).
 - Click  after selecting an output to switch the video input to the selected output.
 - Click  after selecting an output to switch the audio and the video inputs to the selected output.
 - Click  after selecting an output to switch the audio only to the selected output.

Input settings are viewed and adjusted.

Defining Video Input Settings

Define the HDMI and HDBT input settings.

To define the video output settings:

1. In the Navigation pane, click **Switching**. The Switching page appears ([Figure 14](#)).
2. Click  on the input button to open the input settings window.

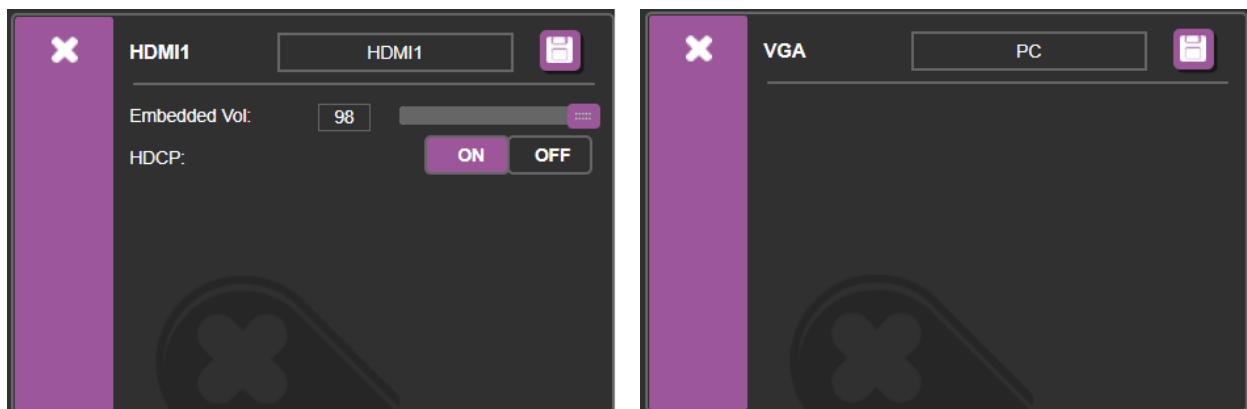





Figure 19: Input Settings

3. Perform the following actions:
 - Change the output label name (up to 16 characters) and click .
 - Set the volume of the embedded audio signal.
 - Set HDCP ON or OFF.

HDMI/HDBT input settings are defined.



Adjusting and Muting the Speaker and Monitor Audio

To Mute Audio:

1. In the Navigation pane, click **Switching**.
The Switching page appears ([Figure 14](#)).
2. Slide a speaker (SPK) and/or Monitor volume slider or type a number in the field above the slider and press Enter.
3. Click the speaker (SPK) and/or Monitor icon  located under the volume sliders.
The Audio Mute icon  displays an x and the volume of the output selected is muted.
Speaker and Monitor Audio is adjusted.

Switching an Input to an Output

To switch an input to an output:

1. In the Navigation pane, click **Switching**.
The Switching page appears ([Figure 14](#)).
2. Click an Output button to which the input is to be routed ([Figure 15](#)).
The Output button's color changes from black to purple.
3. Click any of the following buttons on the selected input button:
 -  to switch the video signal only to the selected output.
 -  to switch the video and audio signals to the selected output.
 -  to switch the audio signal only to the selected output.

The input signal is switched to the selected output.

Using VP-554X with a “Step-in” Device

Remotely manage a Step-In device (for example, Kramer DIP-31) that is connected to VP-554X. In this example, Kramer DIP-31 is connected to the HDMI IN 2.

To control another device remotely:

- 1. Connect the Kramer DIP-31 to an HDMI input (for example HDMI IN 2).
- 2. In the Navigation pane click **Data Routing**. The Data Routing page appears.

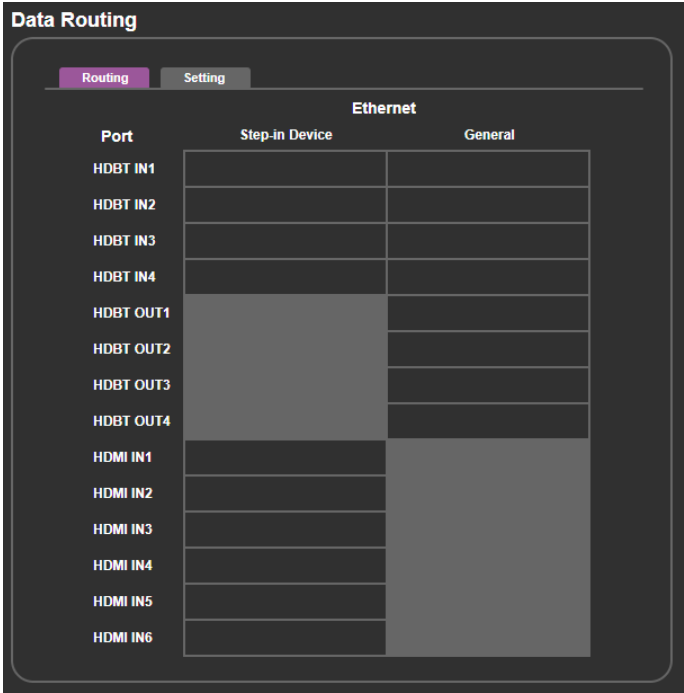

Figure 20: Data Routing Page – Enabling Step-in

- 3. Check HDMI IN2 under Step-in Device.

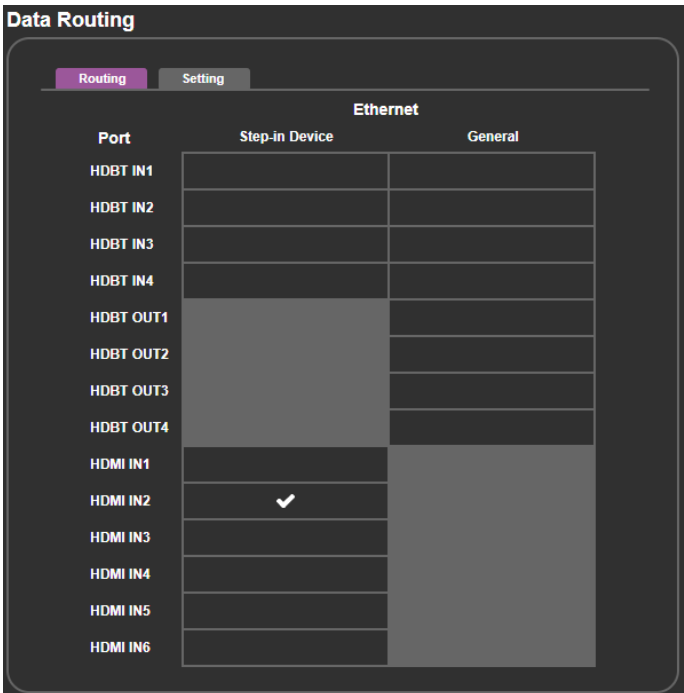



Figure 21: Data Routing Page – Step-in Enabled on HDMI IN2

- In the Navigation pane, click **Switching**. The Switching page appears ([Figure 14](#)).
- Click  on the HDMI IN2 input button. Step-in switching window appears.

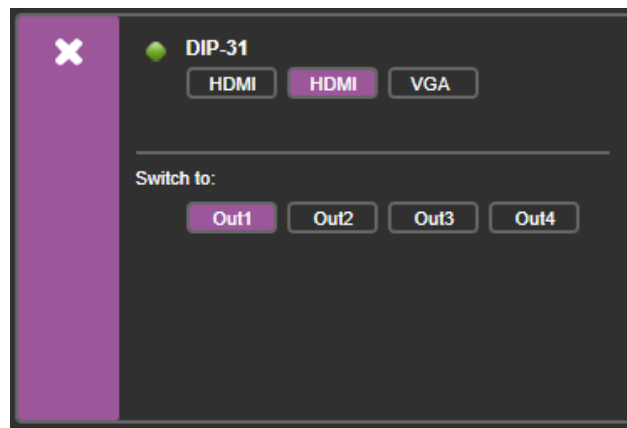

Figure 22: Step-in Switching Window

- Click an Out button and then a **DIP-31** input button. The selected input is switched to the selected output.

The connected remote device is controlled.

Adjusting the Output Image

Define the HDMI/HDBT output settings and adjust their parameters.

To adjust the image for each output:

1. In the Navigation pane, click **Scaler**. The Output 1 tab in the Scaler page appears.

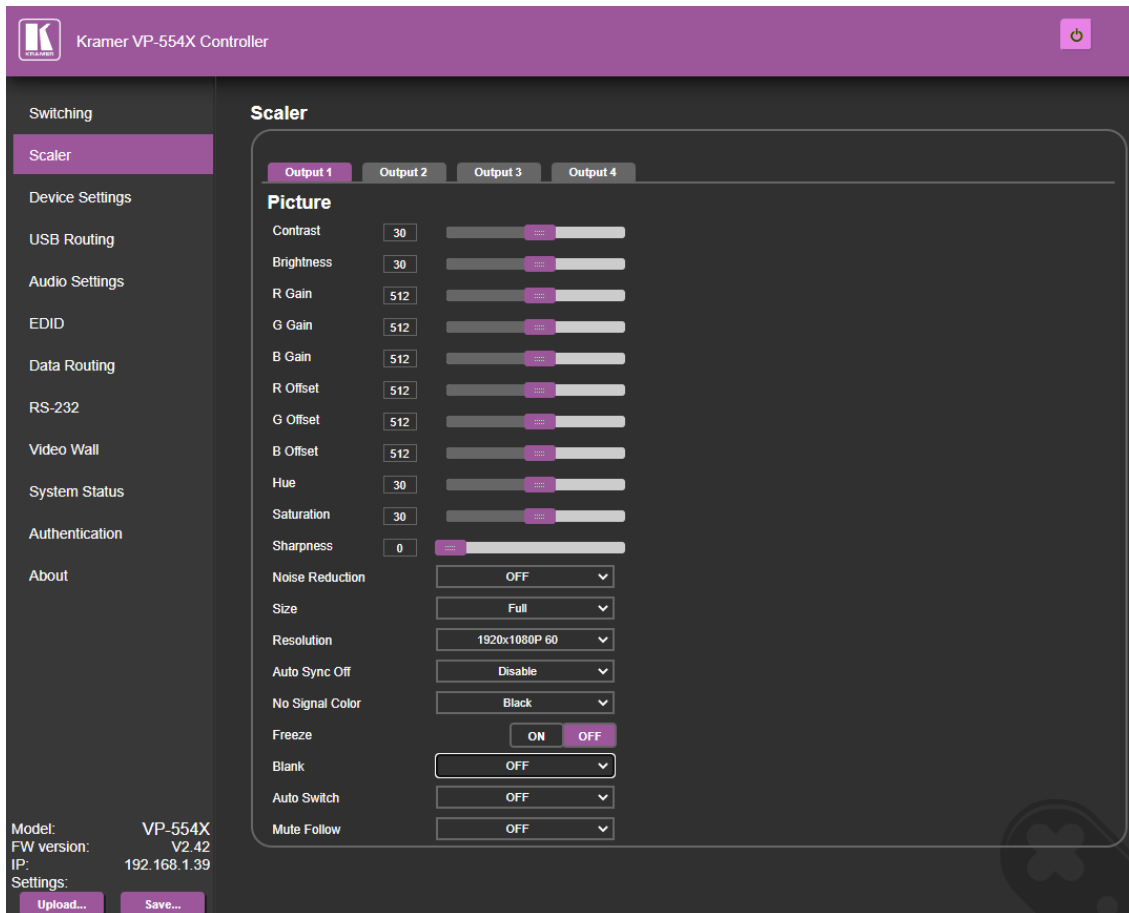

Figure 23: The Scaler Page

2. Select the desired Output.
3. Use the sliders or enter a value to adjust the following parameters:
 - Set the contrast and brightness.
 - Set the RGB gain and offset.
 - Set the hue and saturation.
4. Define the noise reduction level (OFF, Low, middle, High or Auto).
5. Set the image size (Over Scan, Full, Best Fit, Pan Scan, Letter Box, Under 2, Under 1 or Follow In).
6. Select the output resolution from the drop-down list (see [Setting Output Resolution](#) on page 15).
7. Define Auto Sync Off setup (Disable, Fast, Slow or Immediate).
8. Select the color of the output image when no signal is present (Black, White, Blue, Red or Green).

9. Click **ON** to freeze the image.
10. Set the Blank state (OFF, Blank (5V low) or Blank).
11. Define auto switching (OFF (Manual), Auto Scan or Last Connected).
12. Define the mute follow state:
 - Audio is muted upon video Freeze state.
 - Audio is muted upon video Blank state
 - Audio is muted both when image is in the Blank or Freeze state.
 - Mute feature us OFF.

Output image is defined.

Changing Device Settings and Upgrading Firmware

The Device Settings web page shows the device details, such as name, model, MAC address and firmware version and enables performing the following functions:

- [Changing Ethernet Settings](#) on page 41.
- [Performing a Factory Reset](#) on page 42.
- [Performing a Firmware Upgrade](#) on page 42.

Changing Ethernet Settings

To change the Ethernet settings:

1. In the Navigation pane, click **Device Settings**. The Device Settings page appears.

Device Settings

Name: VP-554X
Model: VP-554X
Serial Number: 12345678901234
MAC Address: 00-1D-56-04-79-C2
Firmware Version: V2.42
Firmware Update: Choose File No file chosen Upgrade

DHCP On

DHCP IP Address: 192.168.1.39
Static IP Address: 192.168.1.39
GateWay: 192.168.1.254
Subnet: 255.255.0.0
UDP Port: 50000
TCP Port: 5000 Set Changes

LOCK MODE: ALL
ECHO: ON

Soft Factory Reset

Figure 24: Device Settings Page

2. Uncheck the DHCP check box to change any of the parameters (IP Address, Netmask and/or Gateway). Parameters can be edited.
3. Edit IP Address, Netmask and/or Gateway Parameters and click **Save Changes**.
Ethernet Changes saved.

4. Define the UDP and TCP ports.



- After changing the IP address, reload the web page with the new IP address.
- After changing the subnet mask turn the **VP-554X** power off and then on again.
- If DHCP is checked, you need to reload the web page with the new IP address.

Performing a Firmware Upgrade

To perform firmware upgrade:

1. In the Navigation pane, click **Device Settings**. The Device Settings page appears ([Figure 24](#)).
 2. Click **Choose File**. A browse window appears.
 3. Select the new firmware file, click **Upgrade** and follow the instructions on-screen.
- The new firmware reloads.

Performing a Factory Reset

To reset the device to its factory default values:

1. In the Navigation pane, click **Device Settings**.
The Device Settings page appears ([Figure 24](#)).
2. Click **Soft Factory Reset**.

The following window appears:

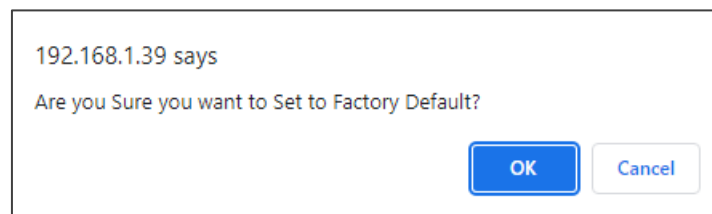

Figure 25: Device Settings Page – Factory Reset

3. Click **OK** to start factory reset and follow the instructions on-screen.
- The device resets to its default parameters.

Routing the USB Switcher

Control the USB switcher via the USB Routing page either by switching one of the four USB inputs to the USB output or by tying each USB input to one of the video inputs so that when a video input is switched to output 1, the USB input that is tied to it switches to the USB output at the same time.

This section enables performing the following actions:

- [Tying a USB Input to a Video Input](#) on page [43](#).
- [Routing the USB Switcher](#) on page [43](#).

Tying a USB Input to a Video Input

You can tie a USB input to any of the available video inputs. By default, USB 1 is tied to HDMI 1, USB 2 is tied to HDMI 2 and so on.

To tie a USB input to a video input:

1. In the Navigation pane, click **USB Routing**. The USB Routing page appears ([Figure 27](#)).
2. Click a USB to HDMI input cross-point in the table to move the USB icon to a different video input. For example, to move USB 2 to VGA, click the USB 2 and VGA cross point. The USB icon appears under VGA.

	HDMI 1	HDMI 2	HDMI 3	HDMI 4	HDMI 5	HDMI 6	HDBT 1	HDBT 2	HDBT 3	HDBT 4	VGA
USB 1	🖱										
USB 2											🖱
USB 3			🖱								
USB 4				🖱							

Figure 26: Tying USB 2 to the VGA Output

Routing the USB Switcher

To switch a USB input to the USB output:

1. In the Navigation pane, click **USB Routing**. The USB Routing page appears ([Figure 27](#)).

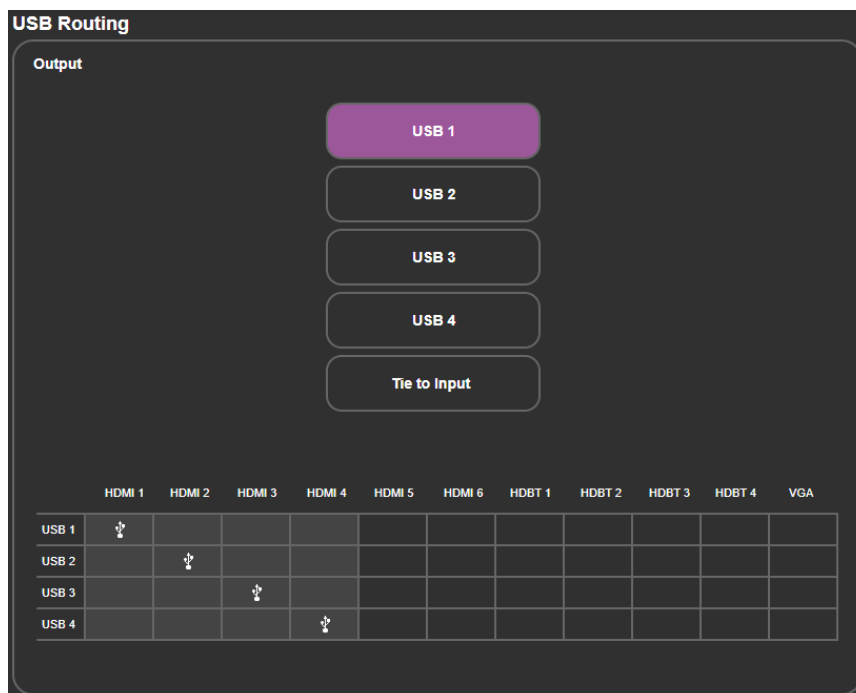

Figure 27: The USB Routing Page

2. Switch a USB input (1 to 4) to the USB out using one of the following ways:
 - Click a USB button (from 1 to 4). The USB input is routed to the USB output.
 - Check that USB inputs are tied properly to the video inputs and click **Tie to Input**.

The USB inputs are switched to the USB output.

Defining Audio Parameters

VP-554X enables switching and adjusting following audio parameters:

Switching the Audio Inputs to the Outputs

To route the audio inputs to the video outputs:

1. In the Navigation pane, click **Audio Settings**. The Audio Settings page appears.

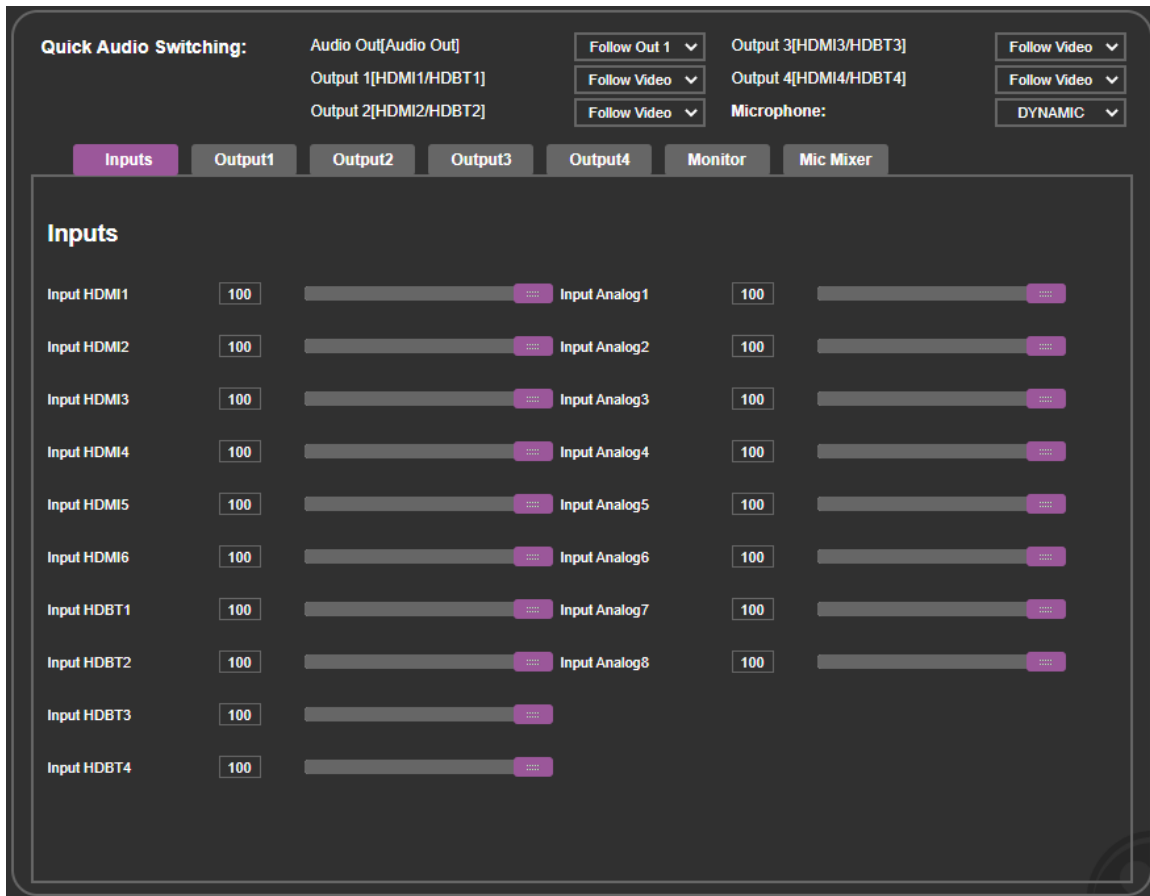

Figure 28: Audio Settings page

2. Next to Quick Audio Switching:
 - Set the monitor and speaker (Audio Out) source from the drop-down list (Follow Out 1 to 4; Mic 1 to 2 or mic 1+2).
 - Set the Output (HDMI/HDBT 1 to 4) source from the drop-down list (HDMI 1 to 6, HDBT 1 to 4, Analog 1 to 8, Mic 1 to 2, mic 1+2 or Follow Video).

Audio inputs are routed to the outputs.

Defining Microphone Operation Mode

1. In the Navigation pane, click **Audio Settings**. The Audio Settings page appears ([Figure 28](#)).
2. Next to Microphone open the drop-down box to set the operation mode (DYNAMIC, CONDENSER).

Microphone operation mode is defined.

Adjusting Audio Input Volume

VP-554X includes 6 HDMI inputs, 4 HDBT inputs and 8 analog inputs.

To adjust the input volume:

1. In the Navigation pane, click **Audio Settings**. The Inputs tab in the Audio Settings page appears ([Figure 28](#)).
2. For each input (HDMI, HDBT and Analog), enter the desired volume or use the slider to set the volume.

Input volume is adjusted.

Setting Audio Output Parameters

Each of the 4 outputs includes an embedded output (HDMI) and an analog output.



To set an output parameter:

1. In the Navigation pane, click **Audio Settings**. The Inputs tab in the Audio Settings page appears ([Figure 28](#)).
2. Select an Output tab (for example, **Output 1**).



Figure 29: Audio Settings Page – Setting the Audio Outputs

3. Perform any of the following actions:

- Adjust the EQUALIZER settings via the sliders.
- Set the Mixer (Output 1 + Mic) level.
- Set the HDMI (embedded audio) volume and hard-stop levels.
- Click  under HDMI Vol to mute the HDMI audio signal.
- Set the LINE (analog audio output) volume and hard-stop levels.
- Click  under LINE Vol to mute the analog audio signal.
- Next to Set Delay, open the drop-down box to set the audio delay time.
- Next to Audio Bypass, select ON to enable Audio Bypass mode (see [Setting Audio Parameters](#) on page 18).
- Next to HDMI Audio Selection, select the audio input type to be switched to the output (Automatic, Embedded or Analog), see [Setting Audio Parameters](#) on page 18.
- Prepare audio Mapping for each audio input to be switched (see [Setting Audio Parameters](#) on page 18).

Audio Out parameters are defined.

Setting Monitor and Speakers Output Parameters

VP-554X audio outputs include the MONITOR (line out) 5-pin terminal block connector and the SPEAKER output.

To set an output parameter:

1. In the Navigation pane, click **Audio Settings**. The Inputs tab in the Audio Settings page appears ([Figure 28](#)).
2. Select the **Monitor** tab.



Figure 30: Audio Settings Page – Setting the Monitor and Speaker Outputs

3. Perform any of the following actions:

- Adjust the EQUALIZER settings via the sliders.
- Set the Mixer (Audio Output + Mic) level.



Audio output includes the Monitor and Speakers outputs.

- Set the SPEAKER volume and hard-stop levels.
- Click  under SPEAKER Vol to mute the HDMI audio signal.
- Set the LINE (monitor output) volume and hard-stop levels.

- Click  under LINE Vol to mute the analog audio signal.
- Next to Set Delay, open the drop-down box to set the audio delay time.
- Next to HDMI Audio Selection, select the audio input type to be switched to the output (Automatic, Embedded or Analog), see [Setting Audio Parameters](#) on page 18.

Monitor and speaker parameters are defined.

Setting Microphone Mixer Parameters

The microphone mixer feature enables mixing an audio output with the input from the microphones.

To set microphone mixer parameters:

1. In the Navigation pane, click **Audio Settings**. The Inputs tab in the Audio Settings page appears ([Figure 28](#)).
2. Select the **Mic Mixer** tab.

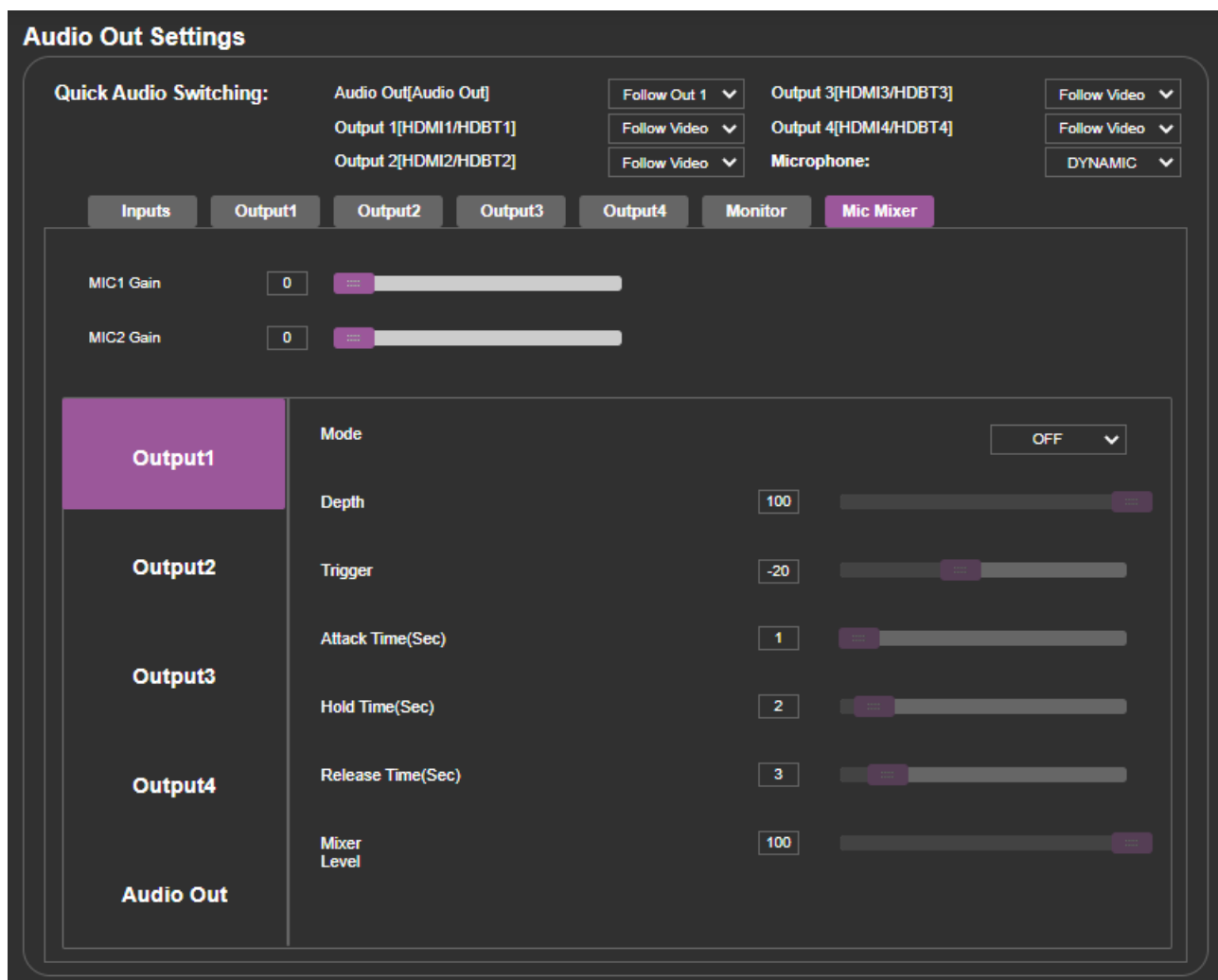

Audio Out Settings

Quick Audio Switching:

Audio Out[Audio Out]	Follow Out 1	Output 3[HDMI3/HDBT3]	Follow Video
Output 1[HDMI1/HDBT1]	Follow Video	Output 4[HDMI4/HDBT4]	Follow Video
Output 2[HDMI2/HDBT2]	Follow Video	Microphone:	DYNAMIC

Inputs | Output1 | Output2 | Output3 | Output4 | Monitor | **Mic Mixer**

MIC1 Gain: 0

MIC2 Gain: 0

Output	Mode	Depth	Trigger	Attack Time(Sec)	Hold Time(Sec)	Release Time(Sec)	Mixer Level
Output1	OFF	100	-20	1	2	3	100
Output2							
Output3							
Output4							
Audio Out							

Figure 31: Audio Settings Page – Setting the Microphone Outputs

3. Next to MIC Gain (1 and 2), enter the gain value or use the sliders to set the value.
4. Select an audio output for setting the microphone mix.
5. Set the microphone operation mode to Mixer, Talk Over or Off for each output.

- Perform any of the following actions as described in [Setting Audio Parameters](#) on page 18.

Microphone mixer parameters are defined.

Managing EDID

The EDID Management page lets you read the EDID from:

- Any of the outputs.
- The default EDID.
- A file in your PC (File BROWSE).

The selected EDID can be copied to the selected input/s.

To copy an EDID from the default, output or user EDID:

- In the Navigation pane, click **Device Settings**. The EDID page appears.

The screenshot shows the EDID Management interface with the following sections:

- Read from:**
 - Default:** VGA Default, 1080P (2CH), 1080P (MCH), 4k3G (2CH), 4k3G (MCH), 4k6G (2CH), 4k6G (MCH)
 - Outputs:** HDMI OUT1, HDBT OUT1, HDMI OUT2, HDBT OUT2, HDMI OUT3, HDBT OUT3, HDMI OUT4, HDBT OUT4
 - User:** HDMI EDID, VGA EDID, Browse...
- Copy to:**
 - Inputs: HDMI 1, HDMI 2, HDMI 3, HDMI 4, HDMI 5, HDMI 6, HDBT 1, HDBT 2, HDBT 3, HDBT 4, PC
- Copy:** A central button with a dropdown menu showing NONE, to, NONE.

Figure 32: EDID Page – Selecting an EDID Source

2. Select an EDID source to read from the:

- Default list.
- Outputs list, including the 4 HDMI and 4 HDBT outputs.
- User list.



When reading from an output, make sure that that output is connected to an acceptor.

- User list, including the user HDMI EDID and VGA EDID (see [Uploading a User EDID](#) on page 51).

3. Select one or more inputs (from the right) to which the EDID is copied.



When a VGA EDID is selected as the source, only the VGA input is available. When an HDMI/HDBT EDID is selected as the source, only the HDMI/HDBT inputs are selected.

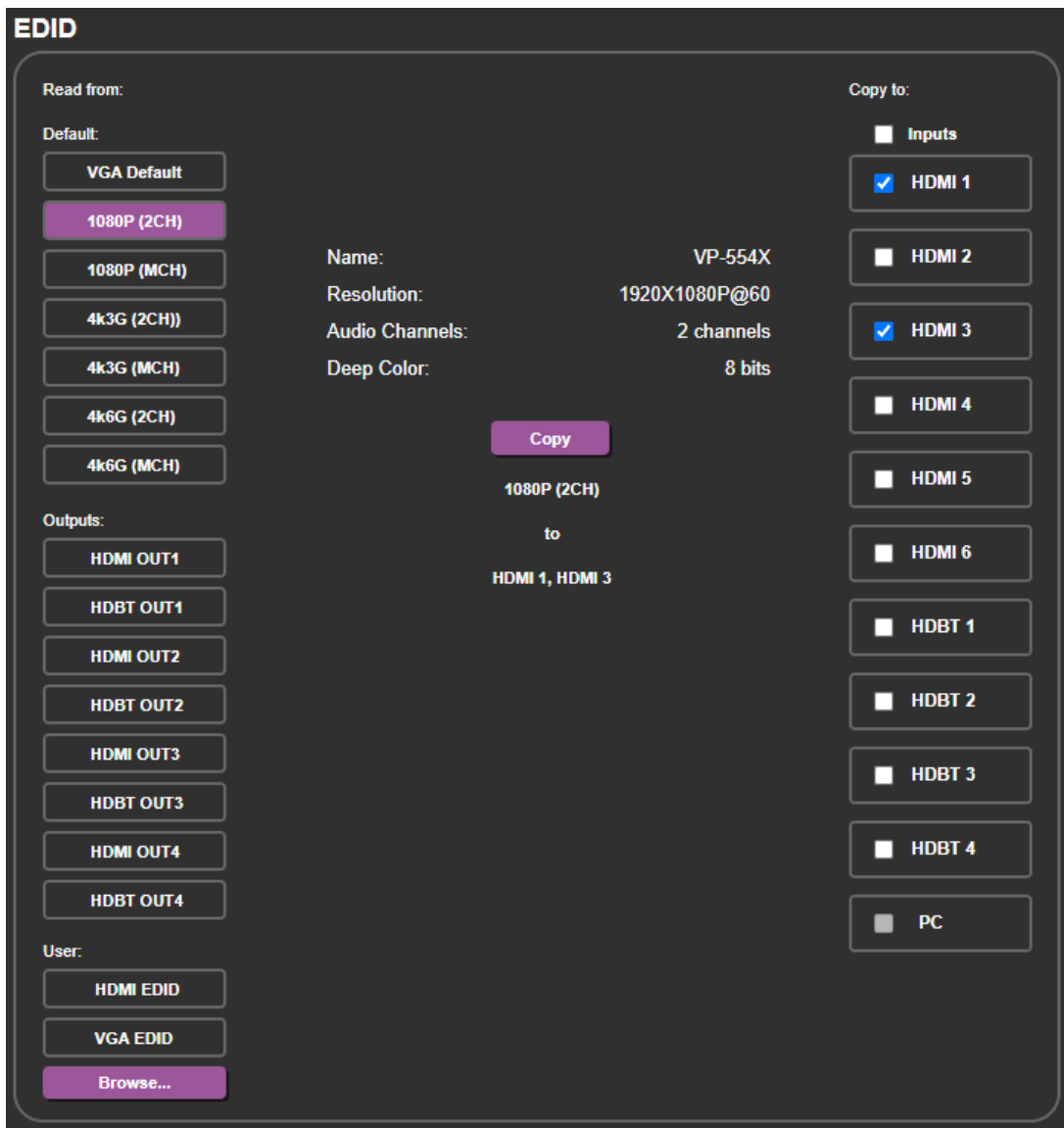

Figure 33: EDID Page – Reading an Input EDID

4. Click **COPY**.

The selected EDID is copied to the selected inputs.

Uploading a User EDID

You can upload a user EDID from your PC.

To upload a user EDID:

1. In the Navigation pane, click **EDID**. The EDID page appears ([Figure 32](#)).
2. Under User, select **HDMI EDID** or **VGA EDID**, as desired.
3. Click **Browse** and select the EDID.
4. Click **Open**.

The selected EDID is uploaded to the relevant User EDID.

Setting Ethernet Data Routing

RS-232 data sent via the Ethernet can be routed over the HDBT ports to a Step-In device or to any transmitter/receiver that is connected to an HDBT port. If an HDBT port is not selected, that port will not route the Ethernet RS-232 data.

To route data via the Ethernet:

1. In the Navigation pane, click **Data Routing**. The Data Routing page appears.

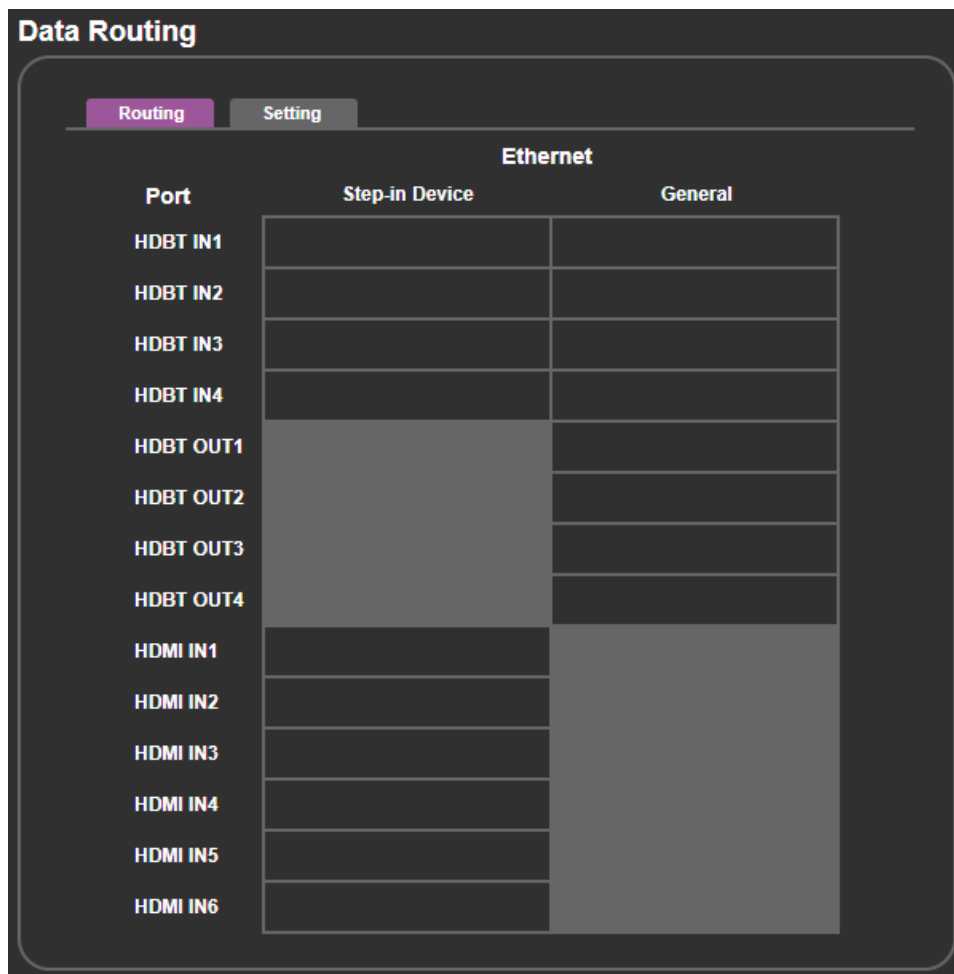

Figure 34: Data Routing Page

2. For each HDBT port, set the data parameters (see [Setting the HDBT Port Data Routing Parameters](#) on page 52).
3. Check:
 - An HDBT/HDMI input under Step-In Device, to pass RS-232 data from a controller that is connected via the connected Step-in device to the HDBT/HDMI input to which it is connected.
 - An HDBT port under General, to pass data from a controller that is connected via the Ethernet port to one of the HDBT inputs or outputs.



If an input or output are not checked, RS-232 data via the Ethernet is not passed.

Data is transferred depending on your selection.

Setting the HDBT Port Data Routing Parameters

To set the HDBT port parameters:

1. In the Navigation pane, click **Data Routing**. The Data Routing page appears.
2. Select the Setting tab. The Setting tab appears.

Figure 35: Data Routing Page

3. For each HDBT port, set the:
 - **Baud Rate:** 4800, 9600, 19200, 38400, 57600 or 115200.
 - **Data Bits:** 5, 6, 7 or 8.

- **Parity:** NONE, ODD or EVEN.
- **Stop Bits:** 1 or 2.
- **Flow Control:** OFF or ON.
- **Protocol:** TCP or UDP.
- **TCP KA (keep alive):** OFF, 1min, 5min, 10min, 15min or 30min.
- **TCP Port:** enter the port number (5100, by default).
- **UDP Port:** enter the port number (51000, by default).
- **Data Channel:** select 0 or 4 (0 by default).



By default, the data channel is set to 0 for Step-in and data routing.

Note that if the Data Channel for an HDBT port is set to 0, in some cases, RS-232 data may not pass from the connected device to the HDBT port. To allow data to be sent, you need to set Data Channel to 4.

For example, when connecting the Kramer **TP-580Txr** to an HDBT port on the **VP-554X**, you need to set the Data Channel to 4 to pass RS-232 data through that HDBT port.

Setting up for RS-232 External Device Control

You can set **VP-554X** to automatically send RS-232 commands to a device (for example, to turn off a projector when no video signal is detected on an **VP-554X** input which is routed to one of the 4 outputs) via the RS-232 EXT. CONTROL port (19) on the **VP-554X** rear panel.

For example, a display is connected to HDMI OUT 1 and to the EXT CONTROL RS-232 port, and IN 2 is routed to OUT 1. If an active signal is connected to IN 2, the 5V ON trigger is applied and the display that is connected to HDMI OUT 1 turns on.

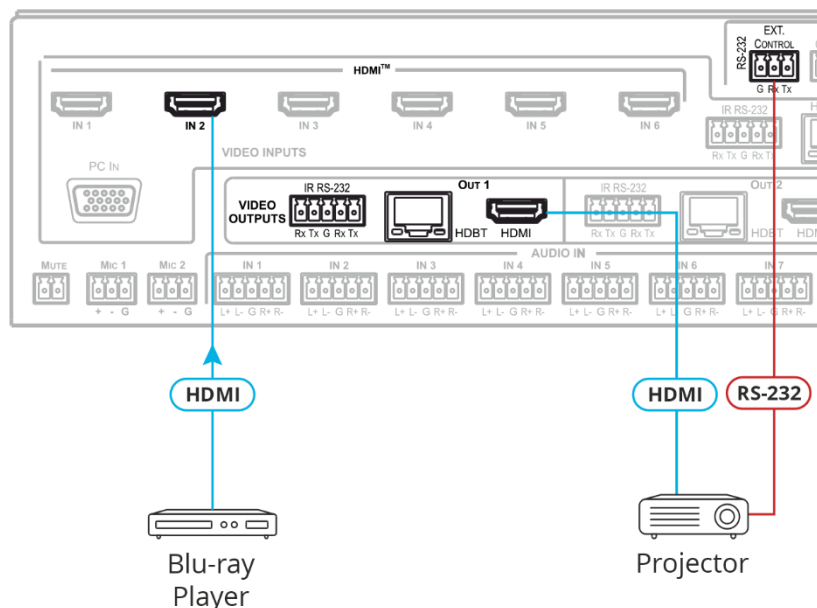

Figure 36: External RS-232 Control to HDMI Output

To use the EXT CONTROL for the HDBT OUT put, simply connect the EXT CONTROL port to the RS-232 port next to OUT 1

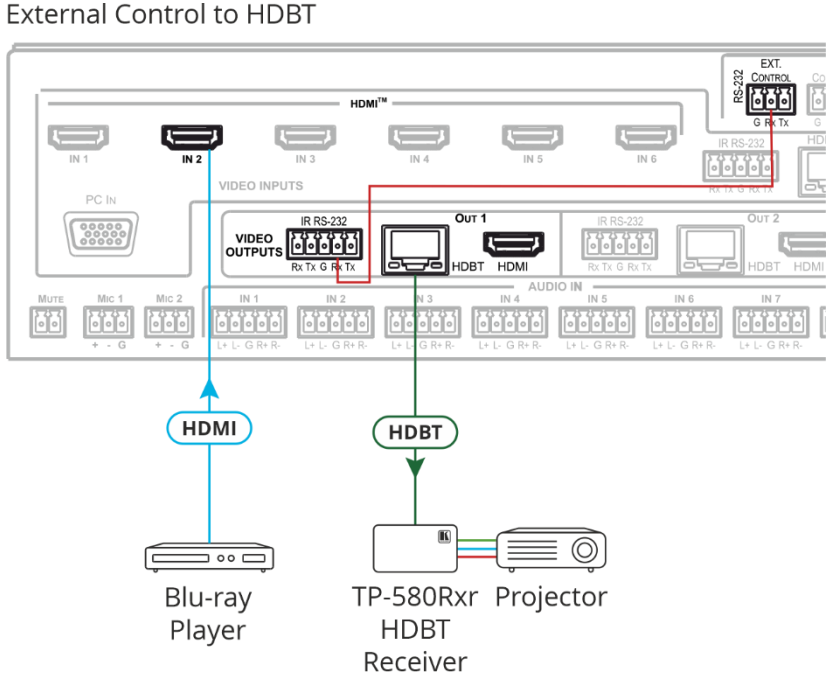

Figure 37: External RS-232 Control to HDBT Output

To configure and send RS-232 commands to an external device:

- 1. In the Navigation pane, click **RS-232**. The RS-232 page appears.

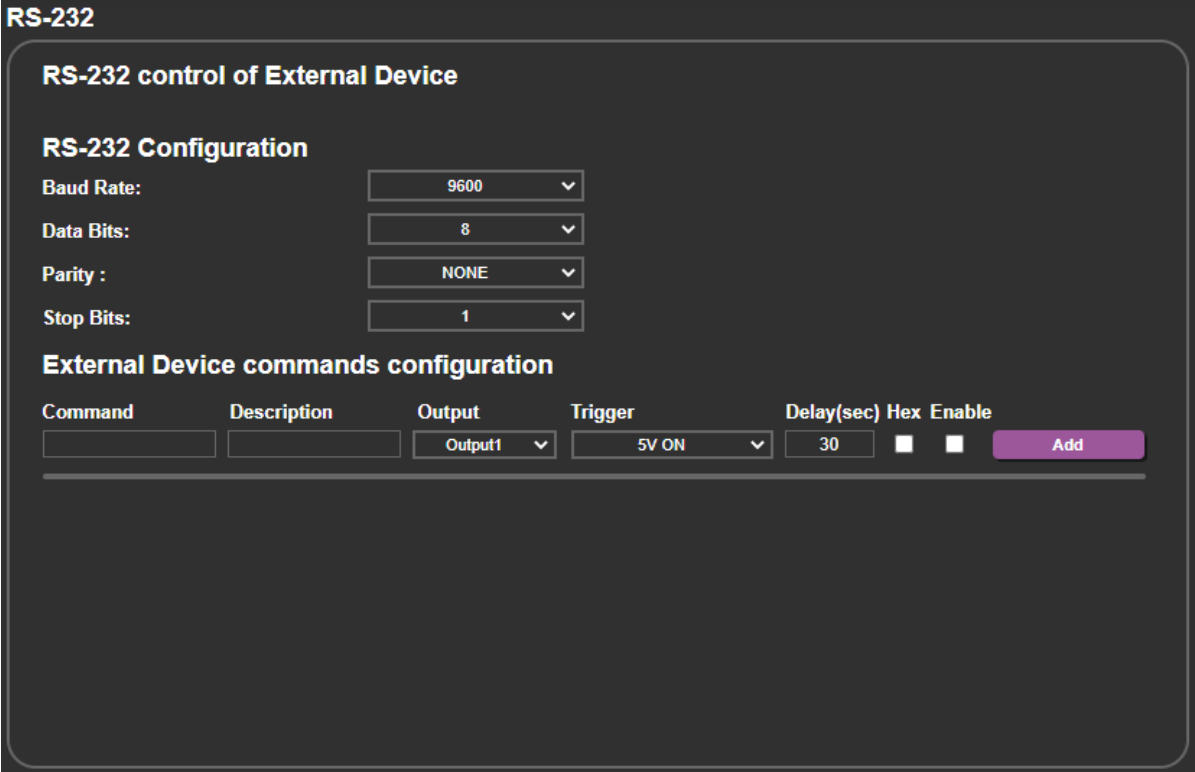
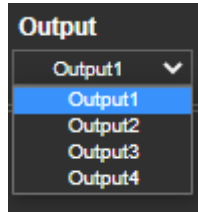

Figure 38: RS-232 Page – Controlling an External Device

- 2. Under RS-232 Configuration, set the external device RS-232 port parameters to enable communication with the acceptor (Baud rate, data bits, parity and stop bits).

3. Configure the commands as follows:

- Enter a device command (for example, turn projector off).
- Enter the command description.
- Select the output to which the command is to be sent (**Output1** to **Output4**).



- Select a trigger from the drop-down box to carry out the command (**5V On**, **5V Off**, **Sync/Clock** or **No Sync/No Clock**).

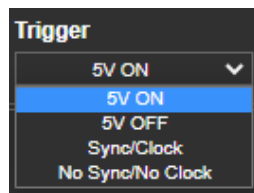

- Enter a delay time, if required.
- Check **Hex** to view the Hex format, if required.
- Check **Enable** to enable the command.

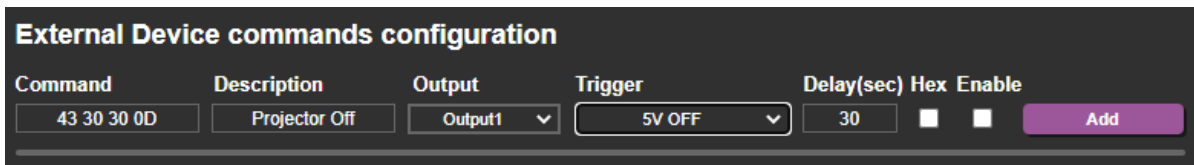

Figure 39: RS-232 – Creating a Command

4. Click **Add**.

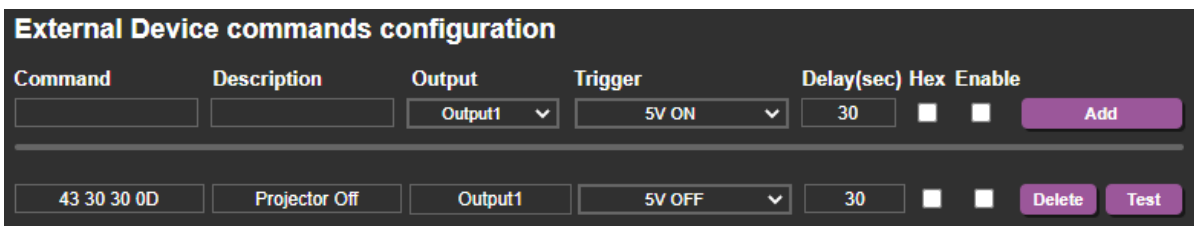

Figure 40: RS-232 Page – Command Added

5. Optionally, perform the following for the command:

- Click **Delete** to delete the command.
- Click **Test** to test the command.
- Change any of the command configurations.
- Enable or disable the command.

6. Add as many commands as needed.

RS-232 commands are configured and can be sent to an external device that is connected to the selected output.

Configuring a Video Wall

You can configure VP-554X as a video wall driver. In this mode, the 4 output ports zoom up a selected output to create a 2X2 videowall.

To configure a video wall:

1. In the Navigation pane, click **Video Wall**. The Video Wall page appears.

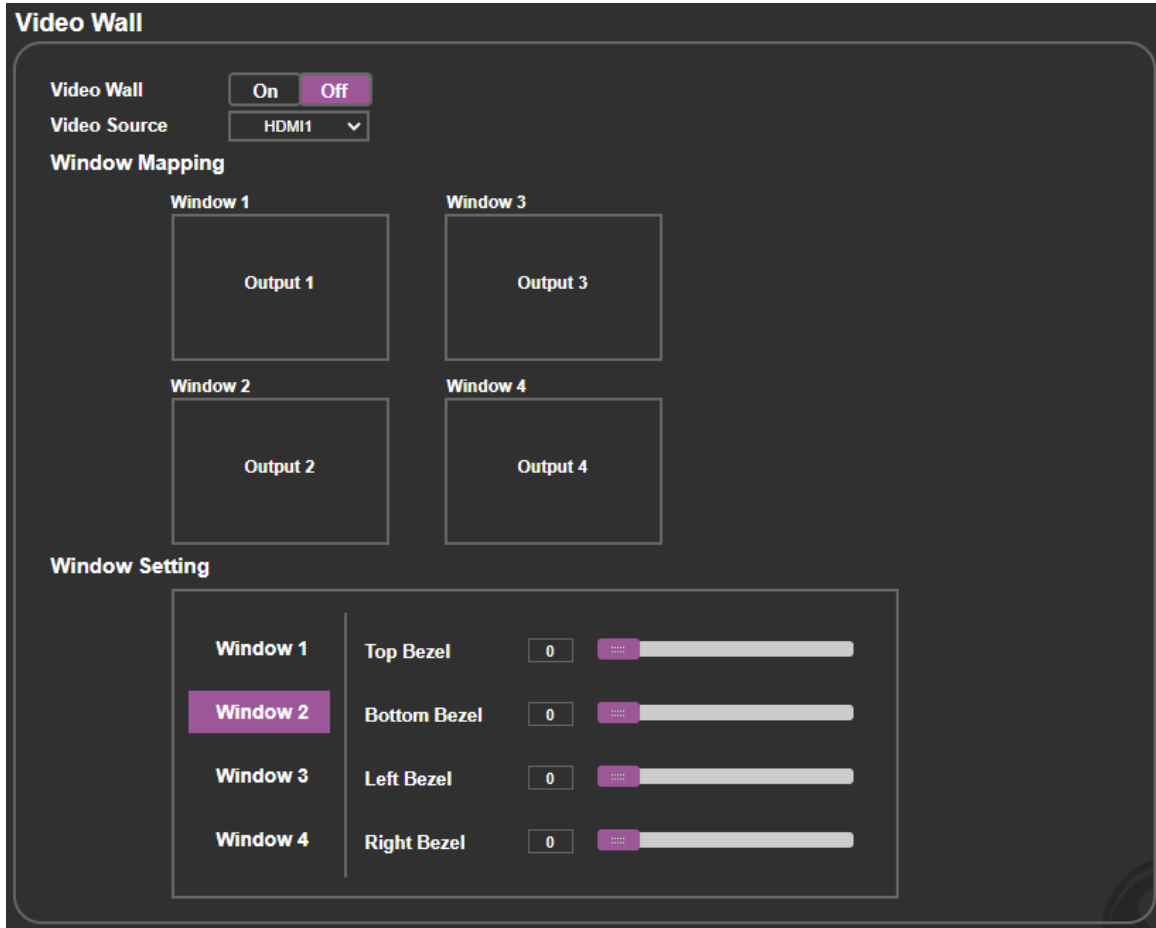

Figure 41: Video Wall Page

2. Click **On** to enable the video wall or click **Off** (default) to disable.
3. Select the Video Source from the drop-down list (HDMI, HDBT or PC inputs).

4. Set the order of the outputs in the following way (windows switch places):

- Click a window. The window border turns purple.
- Click the window to where you want to move this output.

For example, in the example shown in [Figure 41](#), Output 3 is assigned to Window 3 and Output 2 is assigned Window 2. To switch the outputs in those windows, click window 3 and then Window 2. The outputs switch.

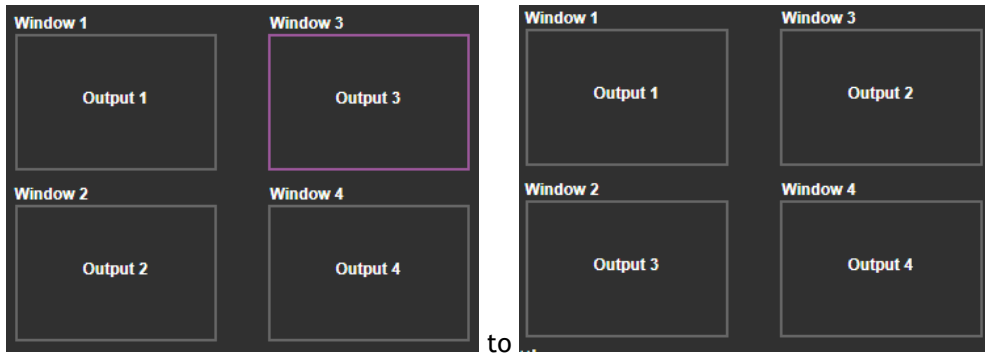

Figure 42: Switching Window Outputs

5. Set the Bezel for each window.

Video wall is configured.

Viewing System Diagnostics

System Status shows the device hardware status. If some hardware failure occurs or any of the parameters exceed their limits, the problem is indicated in the System Status page.

To view the system status:

1. In the Navigation pane, click **System Status**. The System Status page appears.

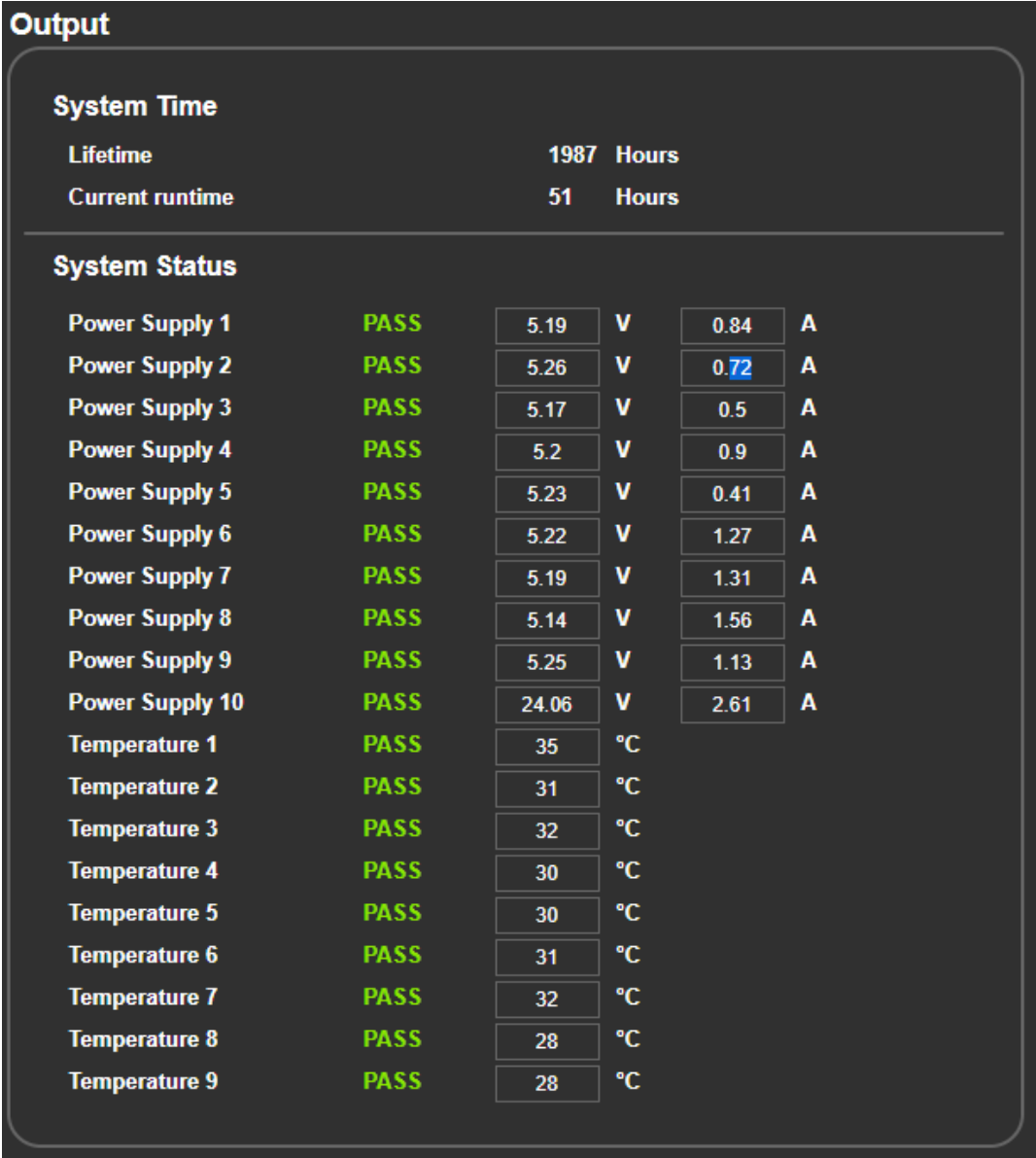

Figure 43: Advanced Page – System Status

2. In the System Status area, view the system lifetime and current runtime (in hours), power supply and temperature indicators.

System status is observed.

Setting Webpage Access

By default, the webpages do not require access permission (user name and password are both: **admin**).

Perform the following actions:

- Set the inactivity logout time (in minutes) and then enable/disable it.
- [Changing the Password](#) on page [59](#).
- [Enabling Authentication](#) on page [60](#).
- [Disabling Authentication](#) on page [61](#).

Changing the Password

To change the password:

1. In the Navigation pane, click **Authentication**. The Authentication page appears.

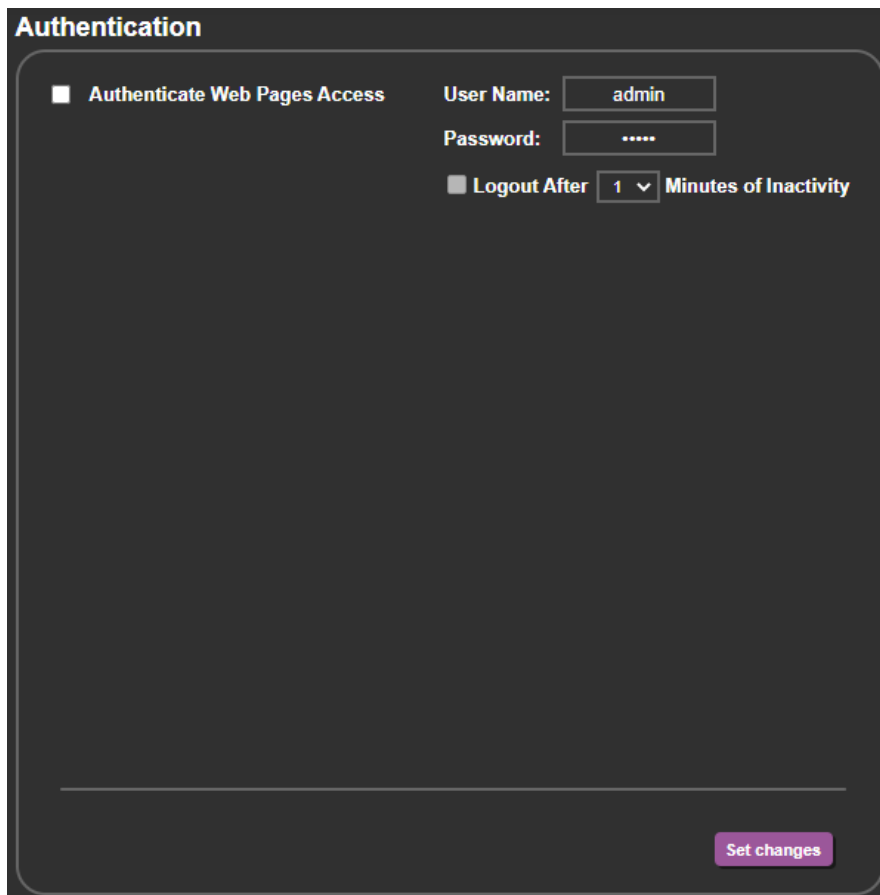

Figure 44: Authentication Page

2. Enter the new password.

3. Click **Set changes**.

The following message appears:

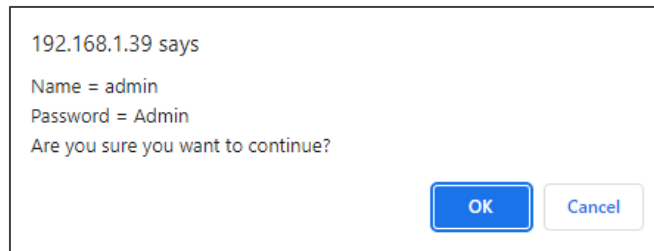

Figure 45: Authentication Page – Changing the Name/Password

4. Click **OK**.

Password has changed.

Enabling Authentication

To enable Authentication:

1. In the Navigation pane, click **Authentication**. The Authentication page appears (see [Figure 44](#)).
2. Check Authenticate Web pages Access.

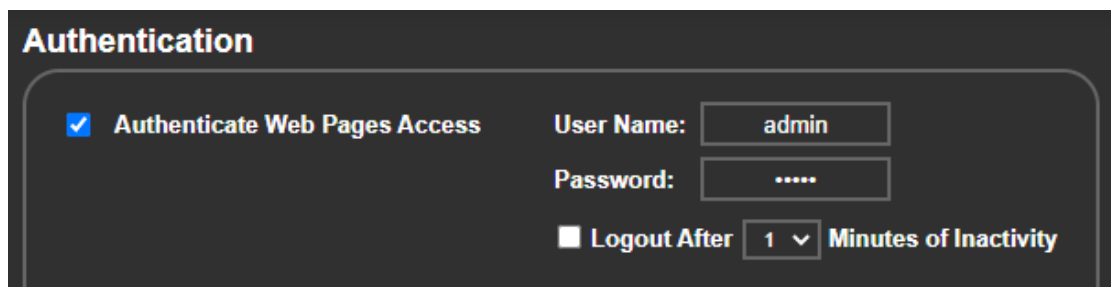

Figure 46: Authentication Page – Password Authentication

3. Click **Set changes**. The following message appears.

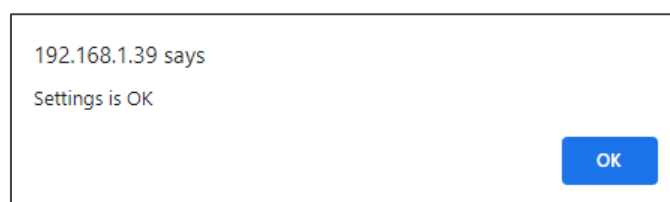

Figure 47: Message

4. Click **OK**.

Authentication is enabled.

Disabling Authentication

To disable security:

1. In the Navigation pane, click **Authentication**. The Authentication page appears.
2. Uncheck **Authenticate Web Pages access**.
3. Click **Set changes**.

The following message appears:



Figure 48: Authentication Page – Security Disable Confirmation

4. Click **OK**.

Authentication is not required.

Setting Timeout

Use the **Timeout Settings** web page to set the time delay before shutdown if no input signal is detected for each output.

To set the timeout:

1. In the Navigation pane, click **Advanced Setting**.

The Advanced Setting page appears.



Figure 49: Advanced Setting page

2. Set the delay time 0-9999 seconds (where 0 is no timeout) and click **SET**.

Timeout is set.

Viewing About Page

The VP-554X About Us page lets you view the web page version and Kramer Electronics Ltd details.



Figure 50: About Page

Technical Specifications

Inputs	6 HDMI	On female HDMI connectors
	1 PC	On a 15-pin HD connector
	4 HDBT	On RJ-45 female connectors
	8 Stereo Analog Balanced Audio	On 5-pin terminal block connectors
	2 Unbalanced Mono Audio	On 3-pin terminal block connectors
Outputs	4 HDMI	On female HDMI connectors
	4 HDBT (mirrored with each HDMI output)	On RJ-45 female connectors
	5 Balanced Stereo Audio	On 5-pin terminal block connectors
	1 Stereo Balanced Audio	On a 4-pin large terminal block
Line Input	Impedance	16.6k Ω
	Maximum level	+14.7dBu (4.2Vrms)
	Sensitivity	Full power @ +8.7dBu (2.1Vrms) for OUT =1.9Vrms
Mic Input	Impedance	47k Ω
	Sensitivity	Full power @ -37dBu (11mVrms) for OUT =1.9Vrms
	Phantom Power	48Vdc on/off per input
Line Output	Impedance	500 Ω
	Frequency Response	20Hz - 20kHz @ +/-1dB
	S/N Ratio:	>75dB, 20Hz - 20kHz (unweighted), >81dB, 20Hz - 20kHz (A-weighted)
	Audio THD + Noise:	<0.014%, 20Hz - 20kHz (unweighted), <0.0092%, 20Hz-20kHz (A-weighted)
	Crosstalk	<-93 dB, 20Hz to 20kHz
Amplifier	Output Power	2 x 20W into 4 Ω
	Amplifier Class	D
	Maximum Voltage Gain	26dB BTL
	Dynamic Range	103 dB A-Weighted
	Frequency Response	20Hz - 20kHz @ +/-1dB
	S/N Ratio	>68 dB, 20Hz - 20kHz (unweighted),
	Audio THD + Noise	<0.037%, 20Hz - 20kHz (unweighted),
	Crosstalk	<-77 dB, 20Hz to 20kHz
Ports	4 IR (for HDBT Outputs) 4 IR (for HDBT Inputs)	On terminal block connectors for IR link extension
	4 RS-232 (for HDBT Outputs) 4 RS-232 (for HDBT Inputs)	On terminal block connectors for serial link extension
	5 USB	4 USB Hosts on USB-B connectors 1 USB Client on a USB-A connector
	1 USB	On a USB-A connector for firmware upgrading
	2 RS-232	On 3-pin terminal block connectors
	4 100BaseT Ethernet	On RJ-45 female connectors for device control and LAN extension
Video	Max Resolution	HDMI: 4K60 4:4:4
		HDBT: 4K60 4:2:0
		PC (VGA):1080p
Compliance	Up to HDMI 2.0 and HDCP 2.2	
Extended Ethernet	Max Transmission Bandwidth	100Mbps

Extended RS-232	Baud Rate	300 to 115200
Control RS-232	Baud Rate	115200
Power	Max, Power Consumption	190VA
Environmental Conditions	Operating Temperature	0° to +40°C (32° to 104°F)
	Storage Temperature	-40° to +70°C (-40° to 158°F)
	Humidity	10% to 90%, RHL non-condensing
Regulatory Compliance	Safety	CE, FCC
	Environmental	RoHs, WEEE
Enclosure	Size	19" 2U
	Type	Aluminum
	Cooling	Fan Ventilation
General	Net Dimensions (W, D, H)	43.7cm x 23.6cm x 8.8cm (17.2" x 9.3" x 3.5")
	Shipping Dimensions (W, D, H)	52.6cm x 47.5cm x 18.4cm (20.7" x 18.7" x 7.2")
	Net Weight	5kg (11lbs)
	Shipping Weight	6.3kg (13.9lbs) approx.
Accessories	Included	Power adapter cord
	Optional	For optimum range and performance use the recommended USB, Ethernet, serial and IR Kramer cables available at www.kramerav.com/product/VP-554X
Specifications are subject to change without notice at www.kramerav.com		

Default Communication Parameters

RS-232	
Baud Rate:	115,200
Data Bits:	8
Stop Bits:	1
Parity:	None
Command Format:	ASCII
Example (Set audio out2 HDMI level to 50):	#AUD-LVL_1,3,-50<CR>
Ethernet	
To reset the IP settings to the factory reset values go to: Menu->Setup -> Factory Reset-> press Enter to confirm	
IP Address:	192.168.1.39
Subnet mask:	255.255.255.0
Default gateway:	192.168.1.254
TCP Port #:	80
Maximum TCP Ports:	1
Default username:	admin
Default password:	admin
Full Factory Reset	
OSD	Go to: Menu-> Setup -> Factory Reset -> press Enter to confirm
Front panel buttons	Press the Reset to XGA/720p Button while plugging the power to reset the machine

Default EDID

Monitor

Model name..... VP-554X
 Manufacturer..... KMR
 Plug and Play ID..... KMR0554
 Serial number..... 1
 Manufacture date..... 2020, ISO week 20
 Filter driver..... None

 EDID revision..... 1.3
 Input signal type..... Digital
 Color bit depth..... Undefined
 Display type..... RGB color
 Screen size..... 310 x 170 mm (13.9 in)
 Power management..... Not supported
 Extension blocs..... 1 (CEA/CTA-EXT)

 DDC/CI..... Not supported

Color characteristics

Default color space..... Non-sRGB
 Display gamma..... 2.20
 Red chromaticity..... Rx 0.594 - Ry 0.349
 Green chromaticity..... Gx 0.339 - Gy 0.521
 Blue chromaticity..... Bx 0.158 - By 0.162
 White point (default).... Wx 0.323 - Wy 0.340
 Additional descriptors... None

Timing characteristics

Horizontal scan range.... 15-136kHz
 Vertical scan range..... 23-61Hz
 Video bandwidth..... 600MHz
 CVT standard..... Not supported
 GTF standard..... Not supported
 Additional descriptors... None
 Preferred timing..... Yes
 Native/preferred timing.. 3840x2160p at 60Hz (16:9)
 Modeline..... "3840x2160" 594.000 3840 4016 4104 4400 2160 2168 2178 2250 +hsync +vsync
 Detailed timing #1..... 1920x1200p at 60Hz (16:10)

Modeline..... "1920x1200" 154.000 1920 1968 2000 2080 1200 1203 1209 1235 +hsync -vsync

Standard timings supported

720 x 400p at 70Hz - IBM VGA
 640 x 480p at 60Hz - IBM VGA
 640 x 480p at 75Hz - VESA
 800 x 600p at 60Hz - VESA
 800 x 600p at 75Hz - VESA
 1024 x 768p at 60Hz - VESA
 1024 x 768p at 75Hz - VESA
 1280 x 1024p at 75Hz - VESA
 1280 x 720p at 60Hz - VESA STD
 1280 x 1024p at 60Hz - VESA STD
 1600 x 900p at 60Hz - VESA STD
 1600 x 1200p at 60Hz - VESA STD
 1920 x 1080p at 60Hz - VESA STD
 1152 x 864p at 75Hz - VESA STD
 1920 x 1200p at 60Hz - VESA STD
 1280 x 800p at 60Hz - VESA STD

EIA/CEA/CTA-861 Information

Revision number..... 3
 IT underscan..... Supported
 Basic audio..... Supported
 YCbCr 4:4:4..... Supported
 YCbCr 4:2:2..... Supported
 Native formats..... 0
 Detailed timing #1..... 1920x1080p at 60Hz (16:9)
 Modeline..... "1920x1080" 148.500 1920 2008 2052 2200 1080 1084 1089 1125 +hsync +vsync
 Detailed timing #2..... 2560x1440p at 60Hz (16:9)
 Modeline..... "2560x1440" 241.500 2560 2608 2640 2720 1440 1443 1448 1481 +hsync -vsync

CE video identifiers (VICs) - timing/formats supported

1920 x 1080p at 60Hz - HDTV (16:9, 1:1)
 1920 x 1080i at 60Hz - HDTV (16:9, 1:1)
 1920 x 1080p at 24Hz - HDTV (16:9, 1:1)
 1920 x 1080p at 30Hz - HDTV (16:9, 1:1)
 1280 x 720p at 60Hz - HDTV (16:9, 1:1)
 720 x 480p at 60Hz - EDTV (16:9, 32:27)
 720 x 576p at 50Hz - EDTV (16:9, 64:45)
 1280 x 720p at 50Hz - HDTV (16:9, 1:1)
 1920 x 1080i at 50Hz - HDTV (16:9, 1:1)
 1920 x 1080i at 50Hz - HDTV (16:9, 1:1)
 1920 x 1080i at 50Hz - HDTV (16:9, 1:1)
 1920 x 1080i at 50Hz - HDTV (16:9, 1:1)
 1920 x 1080i at 50Hz - HDTV (16:9, 1:1)
 1920 x 1080i at 50Hz - HDTV (16:9, 1:1)
 1920 x 1080i at 50Hz - HDTV (16:9, 1:1)
 1920 x 1080i at 50Hz - HDTV (16:9, 1:1)
 1920 x 1080p at 50Hz - HDTV (16:9, 1:1)
 NB: NTSC refresh rate = (Hz*1000)/1001

CE audio data (formats supported)

LPCM 8-channel, 16/20/24 bit depths at 32/44/48 kHz

CE speaker allocation data

Channel configuration.... 7.1
 Front left/right..... Yes
 Front LFE..... Yes
 Front center..... Yes
 Rear left/right..... Yes
 Rear center..... No
 Front left/right center.. No
 Rear left/right center... Yes
 Rear LFE..... No

CE vendor specific data (VSDB)

IEEE registration number. 0x000C03
 CEC physical address..... 1.0.0.0
 Supports AI (ACP, ISRC).. Yes
 Supports 48bpp..... No
 Supports 36bpp..... Yes
 Supports 30bpp..... Yes
 Supports YCbCr 4:4:4..... Yes
 Supports dual-link DVI.. No
 Maximum TMDS clock..... 300MHz
 Audio/video latency (p).. n/a
 Audio/video latency (i).. n/a
 HDMI video capabilities.. Yes
 EDID screen size..... No additional info
 3D formats supported..... Not supported
 Data payload..... 030C001000B83C2F006001030400000000000000000000

CE vendor specific data (VSDB)
 IEEE registration number. 0xC45DD8
 CEC physical address..... 0.1.7.8
 Supports AI (ACP, ISRC).. Yes
 Supports 48bpp..... No
 Supports 36bpp..... No
 Supports 30bpp..... No
 Supports YCbCr 4:4:4..... No
 Supports dual-link DVI... No
 Maximum TMDS clock..... 15MHz

YCbCr 4:2:0 capability map data
 Data payload..... 0F0012

Report information
 Date generated..... 6/28/2022
 Software revision..... 2.91.0.1043
 Data source..... Real-time 0x0031
 Operating system..... 10.0.19044.2

Raw data
 00,FF,FF,FF,FF,FF,FF,00,2D,B2,54,05,01,00,00,00,14,1E,01,03,80,1F,11,78,0A,1E,AC,98,59,56,85,28,
 29,52,57,A5,4B,00,81,C0,81,80,A9,C0,A9,40,D1,C0,71,4F,D1,00,81,00,08,E8,00,30,F2,70,5A,80,B0,58,
 8A,00,A0,5A,00,00,00,1E,28,3C,80,A0,70,B0,23,40,30,20,36,00,A0,64,00,00,00,1A,00,00,00,FC,00,56,
 50,2D,35,35,34,58,0A,20,20,20,20,00,00,00,FD,00,17,3D,0F,88,3C,00,0A,20,20,20,20,01,9F,
 02,03,41,F0,50,10,05,20,22,04,03,12,13,14,61,5D,5F,66,62,64,1F,23,0F,07,07,83,4F,00,00,77,03,0C,
 00,10,00,B8,3C,2F,00,60,01,03,04,00,00,00,00,00,00,00,00,00,67,D8,5D,C4,01,78,80,03,E3,0F,00,
 12,02,3A,80,18,71,38,2D,40,58,2C,45,00,A0,5A,00,00,00,1E,56,5E,00,A0,A0,A0,29,50,30,20,35,00,A0,
 5A,00,00,00,1A,00,77

Protocol 3000

Kramer devices can be operated using Kramer Protocol 3000 commands sent via serial or Ethernet ports.

Understanding Protocol 3000

Protocol 3000 commands are a sequence of ASCII letters, structured according to the following.

- **Command format:**

Prefix	Command Name	Constant (Space)	Parameter(s)	Suffix
#	Command	_	Parameter	<CR>

- **Feedback format:**

Prefix	Device ID	Constant	Command Name	Parameter(s)	Suffix
~	nn	@	Command	Parameter	<CR><LF>

- **Command parameters** – Multiple parameters must be separated by a comma (,). In addition, multiple parameters can be grouped as a single parameter using brackets ([and]).
- **Command chain separator character** – Multiple commands can be chained in the same string. Each command is delimited by a pipe character (|).
- **Parameters attributes** – Parameters may contain multiple attributes. Attributes are indicated with pointy brackets (<...>) and must be separated by a period (.).

The command framing varies according to how you interface with VP-554X. The following figure displays how the # command is framed using terminal communication software (such as Hercules):

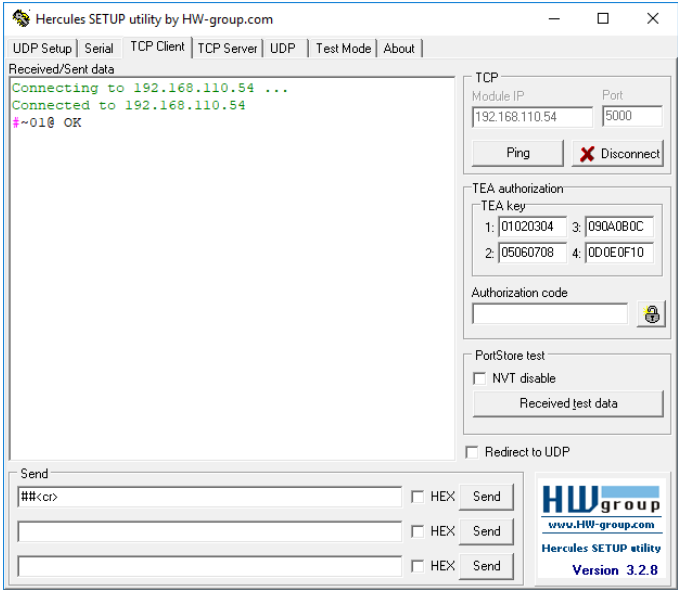

Protocol 3000 Commands

Function	Description	Syntax	Parameters/Attributes	Example
#	Protocol handshaking.  Validates the Protocol 3000 connection and gets the machine number. Step-in master products use this command to identify the availability of a device.	COMMAND #<CR> FEEDBACK ~nn@_ok<CR><LF>		#<CR>
AUD-LVL	Set volume level.	COMMAND #AUD-LVL, <u>io_mode</u> , <u>io_index</u> , <u>vol_level</u> <CR> FEEDBACK ~nn@AUD-LVL, <u>io_mode</u> , <u>io_index</u> , <u>vol_level</u> <CR><LF>	<u>io_mode</u> – Input/Output 0 – Input 1 – Output <u>io_index</u> – Number that indicates the specific input or output port: For Inputs (0) 1 – HDMI1 2 – HDMI2 3 – HDMI3 4 – HDMI4 5 – HDMI5 6 – HDMI6 7 – HDBT1 8 – HDBT2 9 – HDBT3 10 – HDBT4 11 – AUDIO IN1 12 – AUDIO IN2 13 – AUDIO IN3 14 – AUDIO IN4 15 – AUDIO IN5 16 – AUDIO IN6 17 – AUDIO IN7 18 – AUDIO IN8 For Outputs (1) 1 – Output1 HDMI 2 – Output1 LINE 3 – Output2 HDMI 4 – Output2 LINE 5 – Output3 HDMI 6 – Output3 LINE 7 – Output4 HDMI 8 – Output4 LINE 9 – Audio Out Speaker 10 – Audio Out Line <u>vol_level</u> – Volume level 0 to 100 ++ (increase current value by 1dB); -- (decrease current value by 1dB)	Set AUDIO OUT2 HDMI level to -50: #AUD-LVL, <u>1</u> , <u>3</u> , <u>-50</u> <CR>
AUD-LVL	Set volume level.	COMMAND #AUD-LVL, <u>io_mode</u> , <u>io_index</u> , <u>vol_level</u> <CR> FEEDBACK ~nn@AUD-LVL, <u>io_mode</u> , <u>io_index</u> , <u>vol_level</u> <CR><LF>	<u>io_mode</u> – Input/Output 0 – Input 1 – Output <u>io_index</u> – Number that indicates the specific input or output port: For Inputs (0) 1 – HDMI1 2 – HDMI2 3 – HDMI3 4 – HDMI4 5 – HDMI5 6 – HDMI6 7 – HDBT1 8 – HDBT2 9 – HDBT3 10 – HDBT4 11 – AUDIO IN1 12 – AUDIO IN2 13 – AUDIO IN3 14 – AUDIO IN4 15 – AUDIO IN5 16 – AUDIO IN6 17 – AUDIO IN7 18 – AUDIO IN8 For Outputs (1) 1 – Output1 HDMI 2 – Output1 LINE 3 – Output2 HDMI 4 – Output2 LINE 5 – Output3 HDMI 6 – Output3 LINE 7 – Output4 HDMI 8 – Output4 LINE 9 – Audio Out Speaker 10 – Audio Out Line <u>vol_level</u> – Volume level 0 to 100 ++ (increase current value by 1dB); -- (decrease current value by 1dB)	Set AUDIO OUT2 HDMI level to -50: #AUD-LVL, <u>1</u> , <u>3</u> , <u>-50</u> <CR>

Function	Description	Syntax	Parameters/Attributes	Example
AUD-LVL?	Get volume level.	COMMAND #AUD-LVL?_io_mode,io_index<CR> FEEDBACK ~nn@AUD-LVL_io_mode,io_index,vol_level<CR><LF>	io_mode – Input/Output 0 – Input 1 – Output io_index – Number that indicates the specific input or output port: For Inputs (0) 1 – HDMI1 2 – HDMI2 3 – HDMI3 4 – HDMI4 5 – HDMI5 6 – HDMI6 7 – HDBT1 8 – HDBT2 9 – HDBT3 10 – HDBT4 11 – AUDIO IN1 12 – AUDIO IN2 13 – AUDIO IN3 14 – AUDIO IN4 15 – AUDIO IN5 16 – AUDIO IN6 17 – AUDIO IN7 18 – AUDIO IN8 For Outputs (1) 1 – Output1 HDMI 2 – Output1 LINE 3 – Output2 HDMI 4 – Output2 LINE 5 – Output3 HDMI 6 – Output3 LINE 7 – Output4 HDMI 8 – Output4 LINE 9 – Audio Out Speaker 10 – Audio Out Line vol_level – Volume level 0 to 100	Get AUDIO OUT1 HDMI level #AUD-LVL?_1,1<CR>
BUILD-DATE?	Get device build date.	COMMAND #BUILD-DATE?_date,time<CR> FEEDBACK ~nn@BUILD-DATE_date,time<CR><LF>	date – Format: YYYY/MM/DD where YYYY = Year MM = Month DD = Day time – Format: hh:mm:ss where hh = hours mm = minutes ss = seconds	Get the device build date: #BUILD-DATE?<CR>
CPEDID	Copy EDID data from the output to the input EEPROM. ⓘ Destination bitmap size depends on device properties (for 64 inputs it is a 64-bit word). Example: bitmap 0x0013 means inputs 1,2 and 5 are loaded with the new EDID. In certain products Safe_mode is an optional parameter. See the HELP command for its availability.	COMMAND #CPEDID_edid_io,src_id,edid_io,dest_bitmap<CR> or #CPEDID_edid_io,src_id,edid_io,dest_bitmap,safe_mode<CR> FEEDBACK ~nn@CPEDID_edid_io,src_id,edid_io,dest_bitmap<CR><LF> ~nn@CPEDID_edid_io,src_id,edid_io,dest_bitmap,safe_mode<CR><LF>	edid_io – EDID source type (usually output) 1 – Output src_id – Number of chosen source stage 1 – HDMI1 2 – HDBT1 3 – HDMI2 4 – HDBT2 5 – HDMI3 6 – HDBT3 7 – HDMI4 8 – HDBT4 edid_io – EDID destination type (usually input) 0 – Input dest_bitmap – Bitmap representing destination IDs. Format: XXXX...X, where X is hex digit. The binary form of every hex digit represents corresponding destinations. When several inputs are selected (for example, HDMI1, HDMI6 and HDBT1), the parameter should be 0x61 (the sum of 0x01, 0x20 and 0x40). 0x01 – HDMI1 0x02 – HDMI2 0x04 – HDMI3 0x08 – HDMI4 0x10 – HDMI5 0x20 – HDMI6 0x40 – HDBT1 0x80 – HDBT2 0x100 – HDBT3 0x200 – HDBT4 safe_mode – Safe mode 0 – device accepts the EDID as is without trying to adjust 1 – device tries to adjust the EDID (default value if no parameter is sent)	Copy the EDID data from the Output HDMI1 (EDID source) to the HDMI1 Input: #CPEDID_1,1,0,0x01<CR>

Function	Description	Syntax	Parameters/Attributes	Example
DISPLAY?	Get output HPD status.	COMMAND #DISPLAY?_out_index<CR> FEEDBACK ~nn@DISPLAY_out_index,status<CR><LF>	out_index – Number that indicates the specific output: 1-N (N= the total number of outputs) 1 – HDMI1 2 – HDBT1 3 – HDMI2 4 – HDBT2 5 – HDMI3 6 – HDBT3 7 – HDMI4 8 – HDBT4 status – HPD status according to signal validation 0 – Signal or sink is not valid 1 – Signal or sink is valid 2 – Sink and EDID is valid	Get the output HPD status of Output 1: #DISPLAY?_1<CR>
ECHO	Set Echoing ON/OFF function. ⓘ Sending commands via RS-232 port while echoing is disabled will result in no status change on UDP/TCP port	COMMAND #ECHO_echo_state<CR> FEEDBACK ~nn@ECHO_echo_state<CR><LF>	echo_state – Enable/Disable link 0 – Off 1 – On	Set Echoing function to ON: #ECHO_1<CR>
ECHO?	Get Echo state (ON/OFF). ⓘ Sending commands via RS-232 port while echoing is disabled will result in no status change on UDP/TCP port	COMMAND #ECHO?<CR> FEEDBACK ~nn@AUD-CH-LINK_echo_state<CR><LF>	echo_state – Enable/Disable link 0 – Off 1 – On	Get Echoing function state: #ECHO?<CR>
EQ-LVL	Set equalization level.	COMMAND #EQ-LVL_io_index,eq_type,eq_level<CR> FEEDBACK ~nn@EQ-LVL_io_index,eq_type,eq_level<CR><LF>	io_index – Number that indicates the specific input or output port: 1-N (N= the total number of input or output ports) 1 – Output1 2 – Output2 3 – Output3 4 – Output4 5 – Audio Out eq_type – Equalizer Types 120 200 500 1200 3000 7500 12000 eq_level – Equalizer level 0 (-10dB) to 20 (0dB) to 40 (10dB)	Set 120 EQ level value for Output 1 to 12: #EQ-LVL_1,120,12<CR>
EQ-LVL?	Get equalization level.	COMMAND #EQ-LVL?_io_index,eq_type<CR> FEEDBACK ~nn@EQ-LVL_io_index,eq_type,eq_level<CR><LF>	io_index – Number that indicates the specific input or output port: 1-N (N= the total number of input or output ports) 1 – Output1 2 – Output2 3 – Output3 4 – Output4 5 – Audio Out eq_type – Equalizer Types 120 200 500 1200 3000 7500 12000 eq_level – Equalizer level 0 (-10dB) to 20 (0dB) to 40 (10dB)	Get 200 EQ level for speaker output 1: #EQ-LVL?_1,200<CR>
ETH-PORT	Set Ethernet port protocol. ⓘ If the port number you enter is already in use, an error is returned. The port number must be within the following range: 0-(2^16-1).	COMMAND #ETH-PORT_port_type,port_id<CR> FEEDBACK ~nn@ETH-PORT_port_type,port_id<CR><LF>	port_type – TCP/UDP port_id – TCP/UDP port number: UDP – 50000 to 50999 TCP – 5000 to 5099	Set the Ethernet port protocol for TCP to port 5001: #ETH-PORT_tcp,5001<CR>
ETH-PORT?	Get Ethernet port protocol.	COMMAND #ETH-PORT?_port_type<CR> FEEDBACK ~nn@ETH-PORT_port_type,port_id<CR><LF>	port_type – TCP/UDP port_id – TCP/UDP port number: UDP – 50000 to 50999 TCP – 5000 to 5099	Get the Ethernet port protocol for UDP: #ETH-PORT?_udp<CR>

Function	Description	Syntax	Parameters/Attributes	Example
FACTORY	<p>Reset device to factory default configuration.</p> <p>i This command deletes all user data from the device. The deletion can take some time.</p> <p>Your device may require powering off and powering on for the changes to take effect.</p>	<p>COMMAND</p> <pre>#FACTORY<CR></pre> <p>FEEDBACK</p> <pre>~nn@FACTORY_ok<CR><LF></pre>		<p>Reset the device to factory default configuration:</p> <pre>#FACTORY<CR></pre>
GEDID	<p>Get EDID support on certain input/output.</p> <p>i For old devices that do not support this command, ~nn@ERR 002<CR><LF> is received.</p>	<p>COMMAND</p> <pre>#GEDID_io_mode,in_index<CR></pre> <p>FEEDBACK</p> <pre>~nn@GEDID_io_mode,in_index,size<CR><LF></pre>	<p>io_mode – Input/Output</p> <p>0 – Input</p> <p>1 – Output</p> <p>in_index – Number that indicates the specific input:</p> <p>1-N (N= the total number of inputs)</p> <p>For Inputs (0)</p> <p>1 – HDMI1</p> <p>2 – HDMI2</p> <p>3 – HDMI3</p> <p>4 – HDMI4</p> <p>5 – HDMI5</p> <p>6 – HDMI6</p> <p>7 – HDBT1</p> <p>8 – HDBT2</p> <p>9 – HDBT3</p> <p>10 – HDBT4</p> <p>11 – PC</p> <p>For Outputs (1)</p> <p>1 – HDMI1</p> <p>2 – HDBT1</p> <p>3 – HDMI2</p> <p>4 – HDBT2</p> <p>5 – HDMI3</p> <p>6 – HDBT3</p> <p>7 – HDMI4</p> <p>8 – HDBT4</p> <p>size – Size of data to be sent from device, 0 (no EDID support), 128, 256</p>	<p>Get EDID support information for input 1:</p> <pre>#GEDID_0,1<CR></pre>
HDCP-MOD	<p>Set HDCP mode.</p> <p>i Set HDCP working mode on the device input:</p> <p>HDCP supported - HDCP_ON [default].</p> <p>HDCP not supported - HDCP OFF.</p> <p>HDCP support changes following detected sink - MIRROR OUTPUT.</p> <p>When you define 3 as the mode, the HDCP status is defined according to the connected output in the following priority: OUT 1, OUT 2. If the connected display on OUT 2 supports HDCP, but OUT 1 does not, then HDCP is defined as not supported. If OUT 1 is not connected, then HDCP is defined by OUT 2.</p>	<p>COMMAND</p> <pre>#HDCP-MOD_io_mode,in_index,mode<CR></pre> <p>FEEDBACK</p> <pre>~nn@HDCP-MOD_io_mode,in_index,mode<CR><LF></pre>	<p>io_mode – Input/Output</p> <p>0 – Input</p> <p>1 – Output</p> <p>in_index – Number that indicates the specific input:</p> <p>For Inputs (0)</p> <p>1 – HDMI1</p> <p>2 – HDMI2</p> <p>3 – HDMI3</p> <p>4 – HDMI4</p> <p>5 – HDMI5</p> <p>6 – HDMI6</p> <p>7 – HDBT1</p> <p>8 – HDBT2</p> <p>9 – HDBT3</p> <p>10 – HDBT4</p> <p>For Outputs (1)</p> <p>1 – Output1</p> <p>2 – Output2</p> <p>3 – Output3</p> <p>4 – Output4</p> <p>mode – HDCP mode:</p> <p>For Inputs (0)</p> <p>0 – Off</p> <p>1 – On</p> <p>For Outputs (1)</p> <p>2 – Follow In</p> <p>3 – Follow Out</p>	<p>Set the input HDCP-MODE of IN 1 to Off:</p> <pre>#HDCP-MOD_0,1,0<CR></pre>

Function	Description	Syntax	Parameters/Attributes	Example
HDCP-MOD?	<p>Get HDCP mode.</p> <p>ⓘ Set HDCP working mode on the device input:</p> <p>HDCP supported - HDCP_ON [default].</p> <p>HDCP not supported - HDCP OFF.</p> <p>HDCP support changes following detected sink - MIRROR OUTPUT.</p>	<p>COMMAND</p> <p>#HDCP-MOD?_io_mode,in_index<CR></p> <p>FEEDBACK</p> <p>~nn@HDCP-MOD_io_mode,in_index,mode<CR><LF></p>	<p>io_mode – Input/Output</p> <p>0– Input</p> <p>1– Output</p> <p>in_index – Number that indicates the specific input:</p> <p>For Inputs (0)</p> <p>1– HDMI1</p> <p>2– HDMI2</p> <p>3– HDMI3</p> <p>4– HDMI4</p> <p>5– HDMI5</p> <p>6– HDMI6</p> <p>7– HDBT1</p> <p>8– HDBT2</p> <p>9– HDBT3</p> <p>10 – HDBT4</p> <p>For Outputs (1)</p> <p>1– Output1</p> <p>2– Output2</p> <p>3– Output3</p> <p>4– Output4</p> <p>mode – HDCP mode:</p> <p>For Inputs (0)</p> <p>0– Off</p> <p>1– On</p> <p>For Outputs (1)</p> <p>2– Follow In</p> <p>3– Follow Out</p>	<p>Get the input HDCP-MODE of IN 1 HDMI:</p> <p>#HDCP-MOD?_0,1<CR></p>
HDCP-STAT?	<p>Get HDCP signal status.</p> <p>ⓘ io_mode =1 – get the HDCP signal status of the sink device connected to the specified output.</p> <p>io_mode =0 – get the HDCP signal status of the source device connected to the specified input.</p>	<p>COMMAND</p> <p>#HDCP-STAT?_io_mode,in_index<CR></p> <p>FEEDBACK</p> <p>~nn@HDCP-STAT_io_mode,in_index,status<CR><LF></p>	<p>io_mode – Input/Output</p> <p>0– Input</p> <p>1– Output</p> <p>io_index – Number that indicates the specific number of inputs or outputs (based on io_mode):</p> <p>For Inputs (0)</p> <p>1– HDMI1</p> <p>2– HDMI2</p> <p>3– HDMI3</p> <p>4– HDMI4</p> <p>5– HDMI5</p> <p>6– HDMI6</p> <p>7– HDBT1</p> <p>8– HDBT2</p> <p>9– HDBT3</p> <p>10 – HDBT4</p> <p>For Outputs (1)</p> <p>1– Output1</p> <p>2– Output2</p> <p>3– Output3</p> <p>4– Output4</p> <p>status – Signal encryption status - valid values On/Off</p> <p>0–Off</p> <p>1–On</p>	<p>Get the output HDCP-STATUS of IN 1:</p> <p>#HDCP-STAT?_0,1,1<CR></p>
HELP	<p>Get command list or help for specific command.</p>	<p>COMMAND</p> <p>#HELP<CR></p> <p>#HELP_cmd_name<CR></p> <p>FEEDBACK</p> <p>1. Multi-line:</p> <p>~nn@Device_cmd_name,_cmd_name.<CR><LF></p> <p>To get help for command use: HELP (COMMAND_NAME)<CR><LF></p> <p>~nn@HELP_cmd_name:<CR><LF></p> <p>description<CR><LF></p> <p>USAGE:usage<CR><LF></p>	<p>cmd_name – Name of a specific command</p>	<p>Get the command list:</p> <p>#HELP<CR></p> <p>To get help for AV-SW-TIMEOUT:</p> <p>HELP_av-sw-timeout<CR></p>
IMAGE-PROP	<p>Set the image size.</p> <p>ⓘ Sets the image properties of the selected scaler.</p>	<p>COMMAND</p> <p>#IMAGE-PROP_scaler_id,video_mode<CR></p> <p>FEEDBACK</p> <p>~nn@IMAGE-PROP_scaler_id,video_mode<CR><LF></p>	<p>scaler_id – output number –</p> <p>1– Output1</p> <p>2– Output2</p> <p>3– Output3</p> <p>4– Output4</p> <p>video_mode – Status</p> <p>0– Over Scan</p> <p>1– Full</p> <p>2– Best Fit</p> <p>3– Pan Scan</p> <p>4– Letter Box</p> <p>5– Under 2</p> <p>6– Under 1</p> <p>7– Follow In</p>	<p>Set the image size to Full on Output 1:</p> <p>#IMAGE-PROP_1,1<CR></p>

Function	Description	Syntax	Parameters/Attributes	Example
IMAGE-PROP?	Get the image size. ① Gets the image properties of the selected scaler.	COMMAND #IMAGE-PROP?_u<CR> FEEDBACK ~nn@IMAGE-PROP_u,scaler_id,video_mode...<CR><LF>	scaler_id – output number – 1 – Output1 2 – Output2 3 – Output3 4 – Output4 video_mode – Status 0 – Over Scan 1 – Full 2 – Best Fit 3 – Pan Scan 4 – Letter Box 5 – Under 2 6 – Under 1 7 – Follow In	Get the image size for output 1: #IMAGE-PROP?_1<CR>
INFO-PRST?	LEGACY COMMAND. Get maximum preset count. ① In most units, video and audio presets with the same number are stored and recalled together by commands #PRST-STO and #PRST-RCL.	COMMAND #INFO-PRST?_u<CR> FEEDBACK ~nn@INFO-PRST_vid,video_preset_count,audio_preset_count<CR><LF>	video_preset_count – Maximum number of video presets in the unit audio_preset_count – Maximum number of audio presets in the unit	Get number of video and audio presets: #INFO-PRST?_u<CR>
LOCK-FP	Lock the front panel. ① In NT-52N, this command includes the PortNumber (1-2) parameter.	COMMAND #LOCK-FP_u,lock/unlock<CR> FEEDBACK ~nn@LOCK-FP_u,lock/unlock<CR><LF>	lock/unlock – On/Off 0 – Off unlocks front panel buttons or keyboard 1 – On locks front panel buttons or keyboard	Unlock front panel: #LOCK-FP_u,0<CR>
LOCK-FP?	Get the front panel lock state. ① In NT-52N, this command includes the PortNumber (1-2) parameter.	COMMAND #LOCK-FP?_u<CR> FEEDBACK ~nn@LOCK-FP_u,lock/unlock<CR><LF>	lock/unlock – On/Off 0 – Off unlocks front panel buttons or keyboard 1 – On locks front panel buttons or keyboard	Get the front panel lock state: #LOCK-FP?_u<CR>
MIC-GAIN	Set the microphone gain. ① Sets the microphone input audio gain.	COMMAND #MIC-GAIN_mic_id,level<CR> FEEDBACK ~nn@MIC-GAIN_mic_id,level<CR><LF>	mic_id – Input number, 1 – Mic1 2 – Mic2 level – Level – 0 to 100	Set the microphone 1 gain to 50: #MIC-GAIN_u,1,50<CR>
MIC-GAIN?	Get the microphone gain. ① Gets the microphone input audio gain.	COMMAND #MIC-GAIN?_u,mic_id<CR> FEEDBACK ~nn@MIC-GAIN_mic_id,level<CR><LF>	mic_id – Input number, 1 – Mic1 2 – Mic2 level – Level – 0 to 100	Get the microphone 1 gain: #MIC-GAIN?_u,1<CR>
MIC-DELAY	Set the microphone delay time.	COMMAND #MIC-DELAY_mic_id,delay<CR> FEEDBACK ~nn@MIC-DELAY_mic_id,delay<CR><LF>	mic_id – Input number, 1 – Mic1 2 – Mic2 delay – Level – 0 to 85ms	Set the microphone 1 delay to 21ms: #MIC-DELAY_u,1,21<CR>
MIC-DELAY?	Get the microphone delay time.	COMMAND #MIC-DELAY?_u,mic_id<CR> FEEDBACK ~nn@MIC-DELAY_mic_id,delay<CR><LF>	mic_id – Input number, 1 – Mic1 2 – Mic2 delay – 0 to 85ms	Get the microphone 1 delay: #MIC-DELAY?_u,1<CR>
MIX-TLK	Set mic talkover parameters.	COMMAND #MIX-TLK_out_index,mic_index,value<CR> FEEDBACK ~nn@MIX-TLK_out_index,mic_index,value<CR><LF>	out_index – Number that indicates the specific output: 1 – Output1 2 – Output2 3 – Output3 4 – Output4 5 – Audio Out mic_index – Parameter setting 0 – Depth 1 – Trigger 2 – Attack time 3 – Hold time 4 – Release time value – MIC_INDEX value (in corresponding to MIC_INDEX units) For Depth:0-100 For Trigger:0-100(-60-40dB) For Attack time:0-200(0-20.0) For Hold time:0-200(0-20.0) For Release time:0-200(0-20.0)	Set mic depth on output 1 to 20: #MIX-TLK_u,1,0,20<CR>

Function	Description	Syntax	Parameters/Attributes	Example
MIX-TLK?	Get mic talkover parameters.	COMMAND #MIX-TLK?_out_index,mic_index<CR> FEEDBACK ~nn@MIX-TLK_out_index,mic_index,value<CR><LF>	out_index – Number that indicates the specific output: 1 – Output1 2 – Output2 3 – Output3 4 – Output4 5 – Audio Out mic_index – Parameter setting 0 – Depth 1 – Trigger 2 – Attack time 3 – Hold time 4 – Release time value – MIC_INDEX value (in corresponding to MIC_INDEX units) For Depth:0–100 For Trigger:0–100(–60–40dB) For Attack time:0–200(0–20.0) For Hold time:0–200(0–20.0) For Release time:0–200(0–20.0)	Get mic trigger value on output 1: #MIX-TLK?_1,1<CR>
MIX	Set audio MIX.	COMMAND #MIX_out_index,mix_mode<CR> FEEDBACK ~nn@MIX_out_index,mix_mode<CR><LF>	out_index – Number that indicates the specific output: 1 – Output1 2 – Output2 3 – Output3 4 – Output4 5 – Audio Out mix_mode – On/Off 0 – Off 1 – Mixer 2 – Talkover	Set audio MIX on Output 1 to Mixer: #MIX_1,1<CR>
MIX?	Get audio MIX.	COMMAND #MIX?_<CR> FEEDBACK ~nn@MIX_out_index,mix_mode<CR><LF>	out_index – Number that indicates the specific output: 1 – Output1 2 – Output2 3 – Output3 4 – Output4 5 – Audio Out mix_mode – On/Off 0 – Off 1 – Mixer 2 – Talkover	Get audio MIX mode on Output 1: #MIX?_1_<CR>
MIX-LVL	Set mixing level of selected output. <i>i</i> Sets the mixing level between the audio of the selected video In and the selected AUX audio channel.	COMMAND #MIX-LVL_out_index,level<CR> FEEDBACK ~nn@MIX-LVL_out_index,level<CR><LF>	out_index – Number that indicates the specific output: 1 – Output1 2 – Output2 3 – Output3 4 – Output4 5 – Audio Out level – 0 to 100	Set mixing level of Output 1 to 45: #MIX-LVL_1,45<CR>
MIX-LVL?	Get mixing level of selected output. <i>i</i> Gets the mixing level between the audio of the selected video In and the selected AUX audio channel.	COMMAND #MIX-LVL?_out_index<CR> FEEDBACK ~nn@MIX-LVL_out_index,level<CR><LF>	out_index – Number that indicates the specific output: 1 – Output1 2 – Output2 3 – Output3 4 – Output4 5 – Audio Out level – 0 to 100	Get mixing level of Output 1: #MIX-LVL?_1<CR>
MODEL?	Get device model. <i>i</i> This command identifies equipment connected to VP-554X and notifies of identity changes to the connected equipment. The Matrix saves this data in memory to answer REMOTE-INFO requests.	COMMAND #MODEL?_<CR> FEEDBACK ~nn@MODEL_model_name<CR><LF>	model_name – String of up to 19 printable ASCII chars	Get the device model: #MODEL?_<CR>
MUTE	Set audio mute.	COMMAND #MUTE_out_index,mute_mode<CR> FEEDBACK ~nn@MUTE_out_index,mute_mode<CR><LF>	out_index – Number that indicates the specific output: 1 – Output1 HDMI 2 – Output1 LINE 3 – Output2 HDMI 4 – Output2 LINE 5 – Output3 HDMI 6 – Output3 LINE 7 – Output4 HDMI 8 – Output4 LINE 9 – Audio Out Speaker 10 – Audio Out Line mute_mode – On/Off 0 – Off 1 – On	Set Output 1 HDMI to mute: #MUTE_1,1<CR>

Function	Description	Syntax	Parameters/Attributes	Example
MUTE?	Get audio mute.	COMMAND #MUTE?_out_index<CR> FEEDBACK ~nn@MUTE_out_index,mute_mode<CR><LF>	out_index – Number that indicates the specific output: 1 – Output1 HDMI 2 – Output1 LINE 3 – Output2 HDMI 4 – Output2 LINE 5 – Output3 HDMI 6 – Output3 LINE 7 – Output4 HDMI 8 – Output4 LINE 9 – Audio Out Speaker 10 – Audio Out Line mute_mode – On/Off 0 – Off 1 – On	Get mute status of output 1 #MUTE_1?<CR>
NAME	Set machine (DNS) name. ⓘ The machine name is not the same as the model name. The machine name is used to identify a specific machine or a network in use (with DNS feature on).	COMMAND #NAME_machine_name<CR> FEEDBACK ~nn@NAME_machine_name<CR><LF>	machine_name – String of up to 15 alpha-numeric chars (can include hyphen, not at the beginning or end)	Set the DNS name of the device to room-442: #NAME_room-442<CR>
NAME?	Get machine (DNS) name. ⓘ The machine name is not the same as the model name. The machine name is used to identify a specific machine or a network in use (with DNS feature on).	COMMAND #NAME?_<CR> FEEDBACK ~nn@NAME_machine_name<CR><LF>	machine_name – String of up to 15 alpha-numeric chars (can include hyphen, not at the beginning or end)	Get the DNS name of the device: #NAME?_<CR>
NAME-RST	Reset machine (DNS) name to factory default. ⓘ Factory default of machine (DNS) name is "KRAMER_" + 4 last digits of device serial number.	COMMAND #NAME-RST<CR> FEEDBACK ~nn@NAME-RST_ok<CR><LF>		Reset the machine name (S/N last digits are 0102): #NAME-RST_kramer_0102<CR>
NET-DHCP	Set DHCP mode. Connecting Ethernet to devices with DHCP may take more time in some networks. To connect with a randomly assigned IP by DHCP, specify the device DNS name (if available) using the NAME command. You can also get an assigned IP by direct connection to USB or RS-232 protocol port, if available. For proper settings consult your network administrator.	COMMAND #NET-DHCP_dhcp_state<CR> FEEDBACK ~nn@NET-DHCP_dhcp_state<CR><LF>	dhcp_state – 0 – Off 1 – ON	Enable DHCP mode for port 1, if available: #NET-DHCP_1,1<CR>
NET-DHCP?	Get DHCP mode. port.	COMMAND #NET-DHCP?_netw_id<CR> FEEDBACK ~nn@NET-DHCP_netw_id,dhcp_mode<CR><LF>	dhcp_state – 0 – Off 1 – ON	Get DHCP mode: #NET-DHCP?_<CR>
NET-GATE	Set gateway IP. ⓘ A network gateway connects the device via another network and maybe over the Internet. Be careful of security issues. For proper settings consult your network administrator.	COMMAND #NET-GATE_ip_address<CR> FEEDBACK ~nn@NET-GATE_ip_address<CR><LF>	ip_address – Format: xxx.xxx.xxx.xxx	Set the gateway IP address to 192.168.0.1: #NET-GATE_192.168.000.001<CR>
NET-GATE?	Get gateway IP. ⓘ A network gateway connects the device via another network and maybe over the Internet. Be aware of security problems.	COMMAND #NET-GATE?_<CR> FEEDBACK ~nn@NET-GATE_ip_address<CR><LF>	ip_address – Format: xxx.xxx.xxx.xxx	Get the gateway IP address: #NET-GATE?_<CR>
NET-IP	Set IP address. ⓘ For proper settings consult your network administrator.	COMMAND #NET-IP_ip_address<CR> FEEDBACK ~nn@NET-IP_ip_address<CR><LF>	ip_address – Format: xxx.xxx.xxx.xxx	Set the IP address to 192.168.1.39: #NET-IP_192.168.001.039<CR>





Function	Description	Syntax	Parameters/Attributes	Example
NET-IP?	Get IP address.	COMMAND #NET-IP?_<CR> FEEDBACK ~nn@NET-IP_<ip_address><CR><LF>	ip_address – Format: xxx.xxx.xxx.xxx	Get the IP address: #NET-IP?_<CR>
NET-MAC?	Get MAC address. ⓘ For backward compatibility, the id parameter can be omitted. In this case, the Network ID, by default, is 0, which is the Ethernet control port.	COMMAND #NET-MAC?_<id><CR> FEEDBACK ~nn@NET-MAC_<id>,<mac_address><CR><LF>	id – Network ID—the device network interface (if there are more than one). Counting is 0 based, meaning the control port is '0', additional ports are 1,2,3.... mac_address – Unique MAC address. Format: XX-XX-XX-XX-XX-XX where X is hex digit	#NET-MAC?_<id><CR>
NET-MASK	Set subnet mask. ⓘ For proper settings consult your network administrator.	COMMAND #NET-MASK_<net_mask><CR> FEEDBACK ~nn@NET-MASK_<net_mask><CR><LF>	net_mask – Format: xxx.xxx.xxx.xxx	Set the subnet mask to 255.255.0.0: #NET-MASK_255.255.000.000<CR>
NET-MASK?	Get subnet mask.	COMMAND #NET-MASK?_<CR> FEEDBACK ~nn@NET-MASK_<net_mask><CR><LF>	net_mask – Format: xxx.xxx.xxx.xxx	Get the subnet mask: #NET-MASK?<CR>
PROG-ACTION	Set Step-In button action bitmap. ⓘ Programs matrix action as a response for external event (programmable button pressed).	COMMAND #PROG-ACTION_<io_mode>,<in_index>,<button_id>,<bitmap_actions_id><CR> FEEDBACK ~nn@PROG-ACTION_<io_mode>,<in_index>,<button_id>,<bitmap_actions_id><CR><LF>	io_mode – 0 – Input in_index – Number that indicates the specific input: 1 – HDMI1 2 – HDMI2 3 – HDMI3 4 – HDMI4 5 – HDMI5 6 – HDMI6 7 – HDBT1 8 – HDBT2 9 – HDBT3 10 – HDBT4 button_id – 1 bitmap_actions_id – Bitmap representing actions to perform after receiving button_id . format: XXXX...X, where X is a hex digit. 0x01 – Output1 0x02 – Output2 0x04 – Output3 0x08 – Output4	Set step-in button actions on input 3: #PROG-ACTION_0,3,1,0x04<CR>
PROG-ACTION?	Get step-in button action bitmap. ⓘ If different outputs are chosen, for out1+out3, then 0x05 should be as arameter. (0x01+0x04=0x05)	COMMAND #PROG-ACTION?_<io_mode>,<in_index>,<button_id><CR> FEEDBACK ~nn@PROG-ACTION_<io_mode>,<in_index>,<button_id>,<bitmap_actions_id><CR><LF>	io_mode – 0 – Input in_index – Number that indicates the specific input: 1 – HDMI1 2 – HDMI2 3 – HDMI3 4 – HDMI4 5 – HDMI5 6 – HDMI6 7 – HDBT1 8 – HDBT2 9 – HDBT3 10 – HDBT4 button_id – 1 bitmap_actions_id – Bitmap representing actions to perform after receiving button_id . format: XXXX...X, where X is a hex digit. 0x01 – Output1 0x02 – Output2 0x04 – Output3 0x08 – Output4	Get step-in button action bitmap: #PROG-ACTION?_0,3,1<CR>
PROT-VER?	Get device protocol version.	COMMAND #PROT-VER?_<CR> FEEDBACK ~nn@PROT-VER_3000:<version><CR><LF>	version – XX.XX where X is a decimal digit	Get the device protocol version: #PROT-VER?_<CR>
PRST-LST?	Get saved preset list. ⓘ In most units, video and audio presets with the same number are stored and recalled together by commands #PRST-STO and #PRST-RCL.	COMMAND #PRST-LST?_<CR> FEEDBACK ~nn@PRST-LST_<preset>,<preset>,...<CR><LF>	preset – Preset number – 1	Show preset list: #PRST-LST?<CR>
PRST-RCL	Recall saved preset list. ⓘ In most units, video and audio presets with the same number are stored and recalled together by commands #PRST-STO and #PRST-RCL.	COMMAND #PRST-RCL_<preset><CR> FEEDBACK ~nn@PRST-RCL_<preset><CR><LF>	preset – 1	Recall preset: #PRST-RCL_<i>i</i><CR>

Function	Description	Syntax	Parameters/Attributes	Example
PRST-STO	Store current connections, volumes and modes in preset. ⓘ In most units, video and audio presets with the same number are stored and recalled together by commands #PRST-STO and #PRST-RCL.	COMMAND #PRST-STO_preset<CR> FEEDBACK ~nn@PRST-STO_preset<CR><LF>	preset - 1	Store preset: #PRST-STO_1<CR>
RESET	Reset device. ⓘ To avoid locking the port due to a USB bug in Windows, disconnect USB connections immediately after running this command. If the port was locked, disconnect and reconnect the cable to reopen the port.	COMMAND #RESET<CR> FEEDBACK ~nn@RESET_ok<CR><LF>		Reset the device: #RESET<CR>
ROUTE	Set layer routing. ⓘ This command replaces all other routing commands.	COMMAND #ROUTE_layer_type,out_index,in_index<CR> FEEDBACK ~nn@ROUTE_layer_type,out_index<CR><LF>	layer_type Layer Enumeration out_index - Acceptor id in_index - Source id (see ROUTE Command on page 83).	Route video IN 2 HDBT to video OUT 8 HDBT: #ROUTE_1,8,2<CR>
ROUTE?	Get layer routing. ⓘ This command replaces all other routing commands.	COMMAND #ROUTE?_layer_type,out_index<CR> FEEDBACK ~nn@ROUTE_layer_type,out_index,in_index<CR><LF>	layer_type Layer Enumeration out_index - Acceptor id in_index - Source id (see ROUTE Command on page 83).	Get the layer routing: #ROUTE?_layer,dest<CR>
SCLR-AS	Set auto-sync features. ⓘ Sets the auto sync features for the selected scaler.	COMMAND #SCLR-AS_scaler_index, sync_speed<CR> FEEDBACK ~nn@SCLR-AS_scaler_index, sync_speed<CR><LF>	scaler_index - Scaler Number: 1 - Output1 2 - Output2 3 - Output3 4 - Output4 5 - Audio Out sync_speed - 0 - off 1 - fast (10s) 2 - slow (1Min) 3 - Immediate	Set auto-sync on output 1 to Fast: #SCLR-AS_1,1<CR>
SCLR-AS?	Get auto-sync features. ⓘ Gets the auto sync features for the selected scaler.	COMMAND #SCLR-AS?_scaler_index<CR> FEEDBACK ~nn@SCLR-AS_scaler_index, sync_speed<CR><LF>	scaler_index - Scaler Number: 1 - Output1 2 - Output2 3 - Output3 4 - Output4 5 - Audio Out sync_speed - 0 - off 1 - fast (10s) 2 - slow (1Min) 3 - Immediate	Get auto-sync on output 1: #SCLR-AS?_1<CR>
SCLR-AUDIO-DELAY	Set the scaler audio delay. ⓘ Sets the audio delay for the selected audio output.	COMMAND #SCLR-AUDIO-DELAY_scaler_index, delay<CR> FEEDBACK ~nn@SCLR-AUDIO-DELAY_scaler_index, delay<CR><LF>	scaler_index - Scaler Number: 1 - Output1 2 - Output2 3 - Output3 4 - Output4 5 - Audio Out delay - 0 - Off 1 - 10ms 2 - 20ms 3 - 30ms 4 - 40ms 5 - 50ms	Set the scaler audio delay on Output 1 to 10s: #SCLR-AUDIO-DELAY_1,1<CR>
SCLR-AUDIO-DELAY?	Get the scaler audio delay. ⓘ Gets the audio delay for the selected audio output.	COMMAND #SCLR-AUDIO-DELAY?_scaler_index<CR> FEEDBACK ~nn@SCLR-AUDIO-DELAY_scaler_index, delay<CR><LF>	scaler_index - Scaler Number: 1 - Output1 2 - Output2 3 - Output3 4 - Output4 5 - Audio Out delay - 0 - Off 1 - 10ms 2 - 20ms 3 - 30ms 4 - 40ms 5 - 50ms	Get the scaler audio delay for Output 1: #SCLR-AUDIO-DELAY?_1<CR>
SCLR-PCAUTO	Set PC auto sync of scaler. ⓘ Trigger the Auto Adjust feature of PC input.	COMMAND #SCLR-PCAUTO_scaler_index, auto_scan<CR> FEEDBACK ~nn@SCLR-PCAUTO_scaler_index, auto_scan<CR><LF>	scaler_index - Scaler Number: 1 - Output1 2 - Output2 3 - Output3 4 - Output4 auto_scan - 0 - Off 1 - On 3 - Immediate	Set PC auto sync of scaler on output 1 to On: #SCLR-PCAUTO_1,1<CR>

Function	Description	Syntax	Parameters/Attributes	Example
SHOW-OSD	Set the OSD of selected channel.	COMMAND #SHOW-OSD_<out_index>,<switch><CR> FEEDBACK ~nn@SHOW-OSD_<out_index>,<switch><CR><LF>	out_index – Number that indicates the specific output: 1 – Output1 2 – Output2 3 – Output3 4 – Output4 switch – On/Off 0 – Off 1 – On 3 – 5s 4 – 10s	Set the OSD of Output 1: #SHOW-OSD_1,1<CR>
SHOW-OSD?	Get the OSD of selected channel.	COMMAND #SHOW-OSD?_<out_index><CR> FEEDBACK ~nn@SHOW-OSD_<out_index>,<switch><CR><LF>	out_index – Number that indicates the specific output: 1 – Output1 2 – Output2 3 – Output3 4 – Output4 switch – On/Off 0 – Off 1 – On 3 – 5s 4 – 10s	Get the OSD of output 1: #SHOW-OSD?_1<CR>
SIGNAL?	Get input signal status.	COMMAND #SIGNAL?_<in_index><CR> FEEDBACK ~nn@SIGNAL_<in_index>,<status><CR><LF>	in_index – Number that indicates the specific input: 1 – HDMI1 2 – HDMI2 3 – HDMI3 4 – HDMI4 5 – HDMI5 6 – HDMI6 7 – HDBT1 8 – HDBT2 9 – HDBT3 10 – HDBT4 status – Signal status according to signal validation: 0 – Not Valid 1 – Valid 0 – Valid and EDID is OK	Get the input signal lock status of Input 1: #SIGNAL?_1<CR>
SN?	Get device serial number.	COMMAND #SN?_<CR> FEEDBACK ~nn@SN_<serial_num><CR><LF>	serial_num – 14 decimal digits, factory assigned	Get the device serial number: #SN?_<CR>
STANDBY	Set standby mode.	COMMAND #STANDBY_<value><CR> FEEDBACK ~nn@STANDBY_<value><CR><LF>	value – On/Off 0 – Off 1 – On	Set standby mode: #STANDBY_1<CR>
STANDBY?	Get standby mode status.	COMMAND #STANDBY?_<CR> FEEDBACK ~nn@STANDBY_<value><CR><LF>	value – On/Off 0 – Off 1 – On	Get standby mode status: #STANDBY?_<CR>
TLK	Set audio talkover mode status.	COMMAND #TLK_<io_index>,<talkover_mode><CR> FEEDBACK ~nn@TLK_<io_index>,<talkover_mode><CR><LF>	io_index – Number that indicates the specific input or output port: out_index – Number that indicates the specific output: 1 – Output1 2 – Output2 3 – Output3 4 – Output4 5 – Audio Out talkover_mode – Talkover mode 0 – Off 1 – Mixer 2 – Talkover	Set audio talkover mode on Output 1 to Mixer: #TLK_1,1<CR>
TLK?	Get audio talkover mode status.	COMMAND #TLK?_<io_index><CR> FEEDBACK ~nn@TLK_<io_index>,<talkover_mode><CR><LF>	io_index – Number that indicates the specific input or output port: out_index – Number that indicates the specific output: 1 – Output1 2 – Output2 3 – Output3 4 – Output4 5 – Audio Out talkover_mode – Talkover mode 0 – Off 1 – Mixer 2 – Talkover	Get audio talkover mode status for Output 1: #TLK?_1<CR>
VERSION?	Get firmware version number.	COMMAND #VERSION?<CR> FEEDBACK ~nn@VERSION_<firmware_version><CR><LF>	firmware_version – XX.XX.XXXX where the digit groups are: major.minor.build version	Get the device firmware version number: #VERSION?<CR>

Function	Description	Syntax	Parameters/Attributes	Example
VFRZ	Set freeze on selected output.	COMMAND #VFRZ _u ,out_index,freeze_flag<CR> FEEDBACK ~nn@VFRZ _u ,out_index,freeze_flag<CR><LF>	out_index – Number that indicates the specific output: 1 – Output1 2 – Output2 3 – Output3 4 – Output4 freeze_flag – On/Off 0 – Off 1 – On	Set freeze on Output 1: #VFRZ _u ,1,<CR>
VFRZ?	Get output freeze status.	COMMAND #VFRZ? _u ,out_index<CR> FEEDBACK ~nn@VFRZ _u ,out_index,freeze_flag<CR><LF>	out_index – Number that indicates the specific output: 1 – Output1 2 – Output2 3 – Output3 4 – Output4 freeze_flag – On/Off 0 – Off 1 – On	Get Output 1 freeze status: #VFRZ? _u ,1,<CR>
VID-RES	Set output resolution. <i>i</i> “Set” command with is_native=ON sets native resolution on selected output (resolution index sent = 0). Device sends as answer actual VIC ID of native resolution. To use “custom resolutions” (entries 100-105 In View Modes), define them using the DEF-RES command.	COMMAND #VID-RES _u ,io_mode,io_index,is_native,resolution<CR> FEEDBACK ~nn@VID-RES _u ,io_mode,io_index,is_native,resolution<CR><LF> >	io_mode – Output 1 – Output io_index – Number that indicates the specific input or output port: 1 – Output1 2 – Output2 3 – Output3 4 – Output4 is_native – Native resolution flag 0 – Off resolution – Resolution index 0= Native 1=640x480@60Hz 2=800x600@60Hz 3=1024x768@60Hz 4=1280x768@60Hz 5=1280x800@60Hz 6=1280x1024@60Hz 7=1360x768@60Hz 8=1400x1050@60Hz 9=1440x900@60Hz 10=1600x1200@60Hz 11=1680x1050@60Hz 12=1920x1200@60Hz RB 13=2560x1600@60Hz RB 14=1920x1080@60Hz 15=1280x720@60Hz 16=2048x1080@50Hz 17=2048x1080@60Hz 18=2560x1440@60Hz RB 19=3440x1440@30Hz RB 20=3440x1440@60Hz RB 21=720x480p@60Hz 22=1280x720p@60Hz 23=1920x1080p@60Hz 24=720x576p@50Hz 25=1280x720p@50Hz 26=1920x1080p@50Hz 27=1920x1080p@24Hz 28=1920x1080p@25Hz 29=1920x1080p@30Hz 30=2560x1080p@50Hz 31=2560x1080p@60Hz 32=3840x2160p@24Hz 33=3840x2160p@25Hz 34=3840x2160p@30Hz 35=3840x2160p@50Hz 36=3840x2160p@60Hz	Set output 1 resolution to Native: #VID-RES _u ,1,0,0,<CR>

Function	Description	Syntax	Parameters/Attributes	Example
VID-RES?	Get output resolution. ① "Get" command with is_native=ON returns native resolution VIC, with is_native=OFF returns current resolution. To use "custom resolutions" (entries 100-105 In View Modes), define them using the DEF-RES command.	COMMAND #VID-RES?_io_mode,io_index,is_native<CR> FEEDBACK ~nn@VID-RES?_io_mode,io_index,is_native,resolution<CR><LF>	io_mode – Output 1 – Output io_index – Number that indicates the specific input or output port: 1 – Output1 2 – Output2 3 – Output3 4 – Output4 is_native – Native resolution flag 0 – Off resolution – Resolution index 0 = Native 1 = 640x480@60Hz 2 = 800x600@60Hz 3 = 1024x768@60Hz 4 = 1280x768@60Hz 5 = 1280x800@60Hz 6 = 1280x1024@60Hz 7 = 1360x768@60Hz 8 = 1400x1050@60Hz 9 = 1440x900@60Hz 10 = 1600x1200@60Hz 11 = 1680x1050@60Hz 12 = 1920x1200@60Hz RB 13 = 2560x1600@60Hz RB 14 = 1920x1080@60Hz 15 = 1280x720@60Hz 16 = 2048x1080@50Hz 17 = 2048x1080@60Hz 18 = 2560x1440@60Hz RB 19 = 3440x1440@30Hz RB 20 = 3440x1440@60Hz RB 21 = 720x480p@60Hz 22 = 1280x720p@60Hz 23 = 1920x1080p@60Hz 24 = 720x576p@50Hz 25 = 1280x720p@50Hz 26 = 1920x1080p@50Hz 27 = 1920x1080p@24Hz 28 = 1920x1080p@25Hz 29 = 1920x1080p@30Hz 30 = 2560x1080p@50Hz 31 = 2560x1080p@60Hz 32 = 3840x2160p@24Hz 33 = 3840x2160p@25Hz 34 = 3840x2160p@30Hz 35 = 3840x2160p@50Hz 36 = 3840x2160p@60Hz	Get output 1 resolution: #VID-RES?_1,1,0<CR>
VMUTE	Set enable/disable video on output.	COMMAND #VMUTE_level<CR> FEEDBACK ~nn@VMUTE_out_index,flag<CR><LF>	out_index – Number that indicates the specific output: 1 – Output1 2 – Output2 3 – Output3 4 – Output4 flag – Video Mute 0 – Mute On, 5V Off 1 – Mute Off, 5V On 2 – Mute On, 5V On	Disable the video output on Output 2: #VMUTE_2,0<CR>
VMUTE?	Get video on output status.	COMMAND #VMUTE?_out_index<CR> FEEDBACK ~nn@VMUTE_out_index,flag<CR><LF>	out_index – Number that indicates the specific output: 1 – Output1 2 – Output2 3 – Output3 4 – Output4 flag – Video Mute 0 – Mute On, 5V Off 1 – Mute Off, 5V On 2 – Mute On, 5V On	Get video status on Output 2: #VMUTE?_2<CR>
VOLUME	Increase/decrease volume output level	COMMAND #VOLUME_level<CR> FEEDBACK ~nn@VOLUME_level<CR><LF>	level – + – Increase by 1 step - – Decrease by 1 step	Increase the volume: #VOLUME_+<CR>
X-AUD-LVL	Set audio level of a specific signal. ① This is an Extended Protocol 3000 command.	COMMAND #X-AUD-LVL_direction_type.<port_format>.<port_index>.<signal_type>.<index>,audio_level<CR> FEEDBACK ~nn@X-AUD-LVL_direction_type.<port_format>.<port_index>.<signal_type>.<index>,audio_level<CR><LF>	The following attributes comprise the signal ID: ▪ <direction_type> – Direction of the port: o OUT – Output ▪ <port_format> – Type of signal on the port: o HDMI o ANALOG_AUDIO o AMPLIFIED_AUDIO ▪ <port_index> – The port number as printed on the front or rear panel: 1 to 4 o 1 to 4 for HDMI/Analog Audio Outputs o 5 for Monitor Out (Line Out) o 1 for Speaker Output ▪ <signal_type> – Signal ID attribute: o AUDIO ▪ <index> – Indicates a specific channel number when there are multiple channels of the same type: 1 audio_level – Audio level 0 to 100	Set the audio level of MONITOR OUT to 10: #X-AUD-LVL_OUT.ANALOG_AUDIO.5.AUDIO.1,10<CR>

Function	Description	Syntax	Parameters/Attributes	Example
X-AUD-LVL?	<p>Get audio level of a specific signal.</p> <p> This is an Extended Protocol 3000 command.</p>	<p>COMMAND</p> <pre>#X-AUD-LVL?,<direction_type>.<port_format>.<port_index>.<signal_type>.<index><CR></pre> <p>FEEDBACK</p> <pre>~nn@X-AUD-LVL,<direction_type>.<port_format>.<port_index>.<signal_type>.<index>,<audio_level><CR><LF></pre>	<p>The following attributes comprise the signal ID:</p> <ul style="list-style-type: none"> ▪ <direction_type> – Direction of the port: <ul style="list-style-type: none"> ○ OUT – Output ▪ <port_format> – Type of signal on the port: <ul style="list-style-type: none"> ○ HDMI ○ ANALOG_AUDIO ○ AMPLIFIED_AUDIO ▪ <port_index> – The port number as printed on the front or rear panel: 1 to 4 <ul style="list-style-type: none"> ○ 1 to 4 for HDMI/Analog Audio Outputs ○ 5 for Monitor Out (Line Out) ○ 1 for Speaker Output ▪ <signal_type> – Signal ID attribute: <ul style="list-style-type: none"> ○ AUDIO ▪ <index> – Indicates a specific channel number when there are multiple channels of the same type: 1 <p>audio_level – Audio level 0 to 100</p>	<p>Get the audio level of HDMI 1 output:</p> <pre>#X-AUD-LVL?_OUT.HDMI.1.AUDIO.1<CR></pre>
X-MUTE	<p>Set mute ON/OFF on a specific signal.</p> <p> This command is designed to Mute a Signal. This means that it could be applicable on any type of signal. Could be audio, video and maybe IR, USB or data if this capability is supported by the product.</p> <p>This is an Extended Protocol 3000 command.</p>	<p>COMMAND</p> <pre>#X-MUTE,<direction_type>.<port_format>.<port_index>.<signal_type>.<index>,<state><CR></pre> <p>FEEDBACK</p> <pre>~nn@X-MUTE,<direction_type>.<port_format>.<port_index>.<signal_type>.<index>,<state><CR><LF></pre>	<p>The following attributes comprise the signal ID:</p> <ul style="list-style-type: none"> ▪ <direction_type> – Direction of the port: <ul style="list-style-type: none"> ○ OUT – Output ▪ <port_format> – Type of signal on the port: <ul style="list-style-type: none"> ○ HDMI ▪ <port_index> – The port number as printed on the front or rear panel: <ul style="list-style-type: none"> ○ 1 to 4 ▪ <signal_type> – Signal ID attribute: <ul style="list-style-type: none"> ○ VIDEO ▪ <index> – Indicates a specific channel number when there are multiple channels of the same type: 1 <p>state – OFF/ON (not case sensitive)</p>	<p>Mute the video on HDMI OUT 4:</p> <pre>#X-MUTE_OUT.HDMI.4.VIDEO.1,ON<CR></pre>
X-MUTE?	<p>Get mute ON/OFF state on a specific signal.</p> <p> This command is designed to Mute a Signal. This means that it could be applicable on any type of signal. Could be audio, video and maybe IR, USB or data if this capability is supported by the product.</p> <p>This is an Extended Protocol 3000 command.</p>	<p>COMMAND</p> <pre>#X-MUTE?,<direction_type>.<port_format>.<port_index>.<signal_type>.<index><CR></pre> <p>FEEDBACK</p> <pre>~nn@X-MUTE,<direction_type>.<port_format>.<port_index>.<signal_type>.<index>,<state><CR><LF></pre>	<p>The following attributes comprise the signal ID:</p> <ul style="list-style-type: none"> ▪ <direction_type> – Direction of the port: <ul style="list-style-type: none"> ○ OUT – Output ▪ <port_format> – Type of signal on the port: <ul style="list-style-type: none"> ○ HDMI ▪ <port_index> – The port number as printed on the front or rear panel: <ul style="list-style-type: none"> ○ 1 to 4 ▪ <signal_type> – Signal ID attribute: <ul style="list-style-type: none"> ○ VIDEO ▪ <index> – Indicates a specific channel number when there are multiple channels of the same type: 1 <p>state – OFF/ON (not case sensitive)</p>	<p>Get the mute ON/OFF state on HDMI OUT 4:</p> <pre>#X-MUTE?_OUT.HDMI.4.VIDEO.1<CR></pre>
X-ROUTE	<p>Send routing command to matrix.</p> <p> It is recommended to use the command #SIGNALS-LIST to get the list of all signal IDs available in the system and which can be used in this command.</p> <p>Video 1 is the default port in this command and is implied even if not written:</p> <pre>#X-ROUTE_out.sdi.5,in.sdi.1<CR></pre> <p>is interpreted as:</p> <pre>#X-ROUTE_out.sdi.5.video.1,in.sdi.1.video.1<CR></pre> <p>This is an Extended Protocol 3000 command.</p>	<p>COMMAND</p> <pre>#X-ROUTE,<direction_type1>.<port_type1>.<port_index1>.<signal_type1>.<index1>,<direction_type2>.<port_type2>.<port_index2>.<signal_type2>.<index2><CR></pre> <p>FEEDBACK</p> <pre>~nn@X-ROUTE,<direction_type1>.<port_type1>.<port_index1>.<signal_type1>.<index1>,<direction_type2>.<port_type2>.<port_index2>.<signal_type2>.<index2><CR><LF></pre>	<p>The following attributes comprise the signal ID:</p> <ul style="list-style-type: none"> ▪ <direction_type> – Direction of the port: <ul style="list-style-type: none"> ○ IN – Input ○ OUT – Output ▪ <port_format> – Type of signal on the port: <ul style="list-style-type: none"> ○ HDMI ○ HDBT ○ ANALOG_AUDIO ▪ <port_index> – The port number as printed on the front or rear panel ▪ <signal_type> – Signal ID attribute: <ul style="list-style-type: none"> ○ VIDEO ○ AUDIO ▪ <index> – Indicates a specific channel number when there are multiple channels of the same type 	<p>Route HDMI IN 2 to HDMI OUT 3:</p> <pre>#X-ROUTE_out.hdmi.3.video.1,in.hdmi.2.video.1<CR></pre>

Function	Description	Syntax	Parameters/Attributes	Example
X-ROUTE?	<p>Get routing status.</p> <p>! It is recommended to use the command #SIGNALS-LIST to get the list of all signal IDs available in the system and which can be used in this command.</p> <p>VIDEO.1 are the default <signal_type> and <index> in this command and are implied even if not written:</p> <p>#X-ROUTE_out.sdi.5.in.sdi.1<CR></p> <p>is interpreted as:</p> <p>#X-ROUTE_out.sdi.5.video.1,in.sdi.1.video.1<CR></p> <p>This is an Extended Protocol 3000 command.</p>	<p>COMMAND</p> <pre>#X-ROUTE?,<direction_type>.<port_type>.<port_index1>.<signal_type>.<index1><CR></pre> <p>FEEDBACK</p> <pre>~nn@X-ROUTE,<direction_type>.<port_type>.<port_index1>.<signal_type>.<index1>,<direction_type2>.<port_type2>.<port_index2>.<signal_type2>.<index2><CR><LF></pre>	<p>The following attributes comprise the signal ID:</p> <ul style="list-style-type: none"> <direction_type> – <ul style="list-style-type: none"> IN – Input OUT – Output <port_format> – Type of signal on the port: <ul style="list-style-type: none"> HDMI HDBT ANALOG_AUDIO <port_index> – The port number as printed on the front or rear panel <signal_type> – Signal ID attribute: <ul style="list-style-type: none"> VIDEO AUDIO <index> – Indicates a specific channel number when there are multiple channels of the same type 	<p>Get the routing status:</p> <pre>#X-ROUTE?_out.hdmi.5.video.1<CR></pre>
X-SIGNAL?	<p>Get input signal status.</p> <p>! This is an Extended Protocol 3000 command.</p>	<p>COMMAND</p> <pre>#X-SIGNAL?,<direction_type>.<port_format>.<port_index>.<signal_type>.<index><CR></pre> <p>FEEDBACK</p> <pre>~nn@X-SIGNAL,<direction_type>.<port_format>.<port_index>.<signal_type>.<index>,<status><CR><LF></pre>	<p>The following attributes comprise the signal ID:</p> <ul style="list-style-type: none"> <direction_type> – <ul style="list-style-type: none"> IN – Input <port_format> – Type of signal on the port: <ul style="list-style-type: none"> HDMI HDBT <port_index> – The port number as printed on the front or rear panel <signal_type> – Signal ID attribute: <ul style="list-style-type: none"> VIDEO <index> – Indicates a specific channel number when there are multiple channels of the same type <p>status – Input Signal Status</p> <ul style="list-style-type: none"> 0 – No signal 1 – There is a signal 	<pre>#X-SIGNAL_in.hdmi.1.video.1<CR></pre> <pre>~01@X-SIGNAL_in.hdmi.1.video.1,1<CR><LF></pre>

ROUTE Command

layer_type		out_index		in_index		Description
Value	Definition	Value	Definition	Value	Definition	
1	video	1-4	1:Output1 2:Output2 3:Output3 4:Output4	1-11	1:HDMI1 2:HDMI2 3:HDMI3 4:HDMI4 5:HDMI5 6:HDMI6 7:HDBT1 8:HDBT2 9:HDBT3 10:HDBT4 11:PC	Set video source
1	video	0-5	0:no change(VP-554X video source unchange) 1:Output1 2:Output2 3:Output3 4:Output4 5:all(Output1-4)	(7-10):(1-4)	7:1 HDBT1 : step in device input 1 8:2 HDBT2 : step in device input 2 . .	only for step in devices with HDBT out Set VP-554X video source+ step in video source
1	video	0-5	0:no change(VP-554X video source unchange) 1:Output1 2:Output2 3:Output3 4:Output4 5:all(Output1-4)	(1-6):(1-4)	1:1 HDMI1 : step in device input 1 2:2 HDMI 2 : step in device input 2 5:4 HDMI 5: step in device input 4.	only for step in device with HDMI out Set VP-554X video source+ step in source

layer_type		out_index		in_index		Description
Value	Definition	Value	Definition	Value	Definition	
2	audio	1~4	1:Output1 2:Output2 3:Output3 4:Output4	1~21	1:HDMI1 2:HDMI2 3:HDMI3 4:HDMI4 5:HDMI5 6:HDMI6 7:HDBT1 8:HDBT2 9:HDBT3 10:HDBT4 11:ANALOG1 12:ANALOG2 13:ANALOG3 14:ANALOG4 15:ANALOG5 16:ANALOG6 17:ANALOG7 18:ANALOG8 19:MIC1 20:MIC2 21:FOLLOW VIDEO	Set audio source
2	audio	5	Audio Out	1~6	1:MIC1 2:MIC2 3:FOLLOW OUTPUT1 4:FOLLOW OUTPUT2 5:FOLLOW OUTPUT3 6:FOLLOW OUTPUT4	Set audio source
3	usb	1	always 1	1~4	1:USB1 2:USB2 3:USB3 4:USB4	Set USB port
4	serial data	0	0:none(get rid of this function)	7~10/12~15	7:HDBT1 8:HDBT2 9:HDBT3 10:HDBT4 12:HDBT Out1 13:HDBT Out2 14:HDBT Out3 15:HDBT Out4	Disable serial data for ETH Gen.
4	serial data	0	0:none(get rid of this function)	1~10	1:HDMI1 2:HDMI2 3:HDMI3 4:HDMI4 5:HDMI5 6:HDMI6 7:HDBT1 8:HDBT2 9:HDBT3 10:HDBT4	Delete serial data for Step in device
4	serial data	1	1:Eth_Gen	7~10/12~15	7:HDBT1 8:HDBT2 9:HDBT3 10:HDBT4 12:HDBT Out1 13:HDBT Out2 14:HDBT Out3 15:HDBT Out4	Set serial data for ETH Gen.
4	serial data	3	3:Step in devices	1~10	1:HDMI1 2:HDMI2 3:HDMI3 4:HDMI4 5:HDMI5 6:HDMI6 7:HDBT1 8:HDBT2 9:HDBT3 10:HDBT4	Set serial data for step in devices
12	video+audio	1~4	1:Output1 2:Output2 3:Output3 4:Output4	1~10	1:HDMI1 2:HDMI2 3:HDMI3 4:HDMI4 5:HDMI5 6:HDMI6 7:HDBT1 8:HDBT2 9:HDBT3 10:HDBT4	Set video+audio source
12	video+audio	1~4	1:Output1 2:Output2 3:Output3 4:Output4	(1~6): (1~2)	1:1:HDMI1 Embedded 1:2:HDMI1 Analog 2:1:HDMI2 Embedded 2:2:HDMI2 Analog 3:1:HDMI3 Embedded 3:2:HDMI3 Analog 4:1:HDMI4 Embedded 4:2:HDMI4 Analog 5:1:HDMI5 Embedded 5:2:HDMI5 Analog 6:1:HDMI6 Embedded 6:2:HDMI6 Analog	Set video+audio source + audio setting (embedded or Analog)

layer_type		out_index		in_index		Description
Value	Definition	Value	Definition	Value	Definition	
13	video+usb	1	Output1	1~11	1:HDMI1 2:HDMI2 3:HDMI3 4:HDMI4 5:HDMI5 6:HDMI6 7:HDBT1 8:HDBT2 9:HDBT3 10:HDBT4 11:PC	Set video source + USB setting is " Tie to input.
123	video+audio+usb	1	Output1	1~10	1:HDMI1 2:HDMI2 3:HDMI3 4:HDMI4 5:HDMI5 6:HDMI6 7:HDBT1 8:HDBT2 9:HDBT3 10:HDBT4	Set video+audio source + USB setting is "tie to input"
123	video+audio+usb	1	Output1	(1~6):(1~2)	1:1:HDMI1 Embedded 1:2:HDMI1 Analog 2:1:HDMI2 Embedded 2:2:HDMI2 Analog 3:1:HDMI3 Embedded 3:2:HDMI3 Analog 4:1:HDMI4 Embedded 4:2:HDMI4 Analog 5:1:HDMI5 Embedded 5:2:HDMI5 Analog 6:1:HDMI6 Embedded 6:2:HDMI6 Analog	Set video+audio source + audio setting (Embedded or Analog) + USB port " tie to input " .

Result and Error Codes

Syntax

In case of an error, the device responds with an error message. The error message syntax:

- **~NN@ERR XXX<CR><LF>** – when general error, no specific command
- **~NN@CMD ERR XXX<CR><LF>** – for specific command
- **NN** – machine number of device, default = 01
- **XXX** – error code

Error Codes

Error Name	Error Code	Description
P3K_NO_ERROR	0	No error
ERR_PROTOCOL_SYNTAX	1	Protocol syntax
ERR_COMMAND_NOT_AVAILABLE	2	Command not available
ERR_PARAMETER_OUT_OF_RANGE	3	Parameter out of range
ERR_UNAUTHORIZED_ACCESS	4	Unauthorized access
ERR_INTERNAL_FW_ERROR	5	Internal FW error
ERR_BUSY	6	Protocol busy
ERR_WRONG_CRC	7	Wrong CRC
ERR_TIMEDOUT	8	Timeout
ERR_RESERVED	9	(Reserved)
ERR_FW_NOT_ENOUGH_SPACE	10	Not enough space for data (firmware, FPGA...)
ERR_FS_NOT_ENOUGH_SPACE	11	Not enough space – file system
ERR_FS_FILE_NOT_EXISTS	12	File does not exist
ERR_FS_FILE_CANT_CREATED	13	File can't be created
ERR_FS_FILE_CANT_OPEN	14	File can't open
ERR_FEATURE_NOT_SUPPORTED	15	Feature is not supported
ERR_RESERVED_2	16	(Reserved)
ERR_RESERVED_3	17	(Reserved)
ERR_RESERVED_4	18	(Reserved)
ERR_RESERVED_5	19	(Reserved)
ERR_RESERVED_6	20	(Reserved)
ERR_PACKET_CRC	21	Packet CRC error
ERR_PACKET_MISSED	22	Packet number isn't expected (missing packet)
ERR_PACKET_SIZE	23	Packet size is wrong
ERR_RESERVED_7	24	(Reserved)
ERR_RESERVED_8	25	(Reserved)
ERR_RESERVED_9	26	(Reserved)
ERR_RESERVED_10	27	(Reserved)
ERR_RESERVED_11	28	(Reserved)
ERR_RESERVED_12	29	(Reserved)
ERR_EDID_CORRUPTED	30	EDID corrupted
ERR_NON_LISTED	31	Device specific errors
ERR_SAME_CRC	32	File has the same CRC – not changed
ERR_WRONG_MODE	33	Wrong operation mode
ERR_NOT_CONFIGURED	34	Device/chip was not initialized

The warranty obligations of Kramer Electronics Inc. ("Kramer Electronics") for this product are limited to the terms set forth below:

What is Covered

This limited warranty covers defects in materials and workmanship in this product.

What is Not Covered

This limited warranty does not cover any damage, deterioration or malfunction resulting from any alteration, modification, improper or unreasonable use or maintenance, misuse, abuse, accident, neglect, exposure to excess moisture, fire, improper packing and shipping (such claims must be presented to the carrier), lightning, power surges, or other acts of nature. This limited warranty does not cover any damage, deterioration or malfunction resulting from the installation or removal of this product from any installation, any unauthorized tampering with this product, any repairs attempted by anyone unauthorized by Kramer Electronics to make such repairs, or any other cause which does not relate directly to a defect in materials and/or workmanship of this product. This limited warranty does not cover cartons, equipment enclosures, cables or accessories used in conjunction with this product.

Without limiting any other exclusion herein, Kramer Electronics does not warrant that the product covered hereby, including, without limitation, the technology and/or integrated circuit(s) included in the product, will not become obsolete or that such items are or will remain compatible with any other product or technology with which the product may be used.

How Long this Coverage Lasts

The standard limited warranty for Kramer products is seven (7) years from the date of original purchase, with the following exceptions:

1. All Kramer VIA hardware products are covered by a standard three (3) year warranty for the VIA hardware and a standard three (3) year warranty for firmware and software updates; all Kramer VIA accessories, adapters, tags, and dongles are covered by a standard one (1) year warranty.
2. Kramer fiber optic cables, adapter-size fiber optic extenders, pluggable optical modules, active cables, cable retractors, ring mounted adapters, portable power chargers, Kramer speakers, and Kramer touch panels are covered by a standard one (1) year warranty. Kramer 7-inch touch panels purchased on or after April 1st, 2020 are covered by a standard two (2) year warranty.
3. All Kramer Calibre products, all Kramer Minicom digital signage products, all HighSecLabs products, all streaming, and all wireless products are covered by a standard three (3) year warranty.
4. All Sierra Video MultiViewers are covered by a standard five (5) year warranty.
5. Sierra switchers & control panels are covered by a standard seven (7) year warranty (excluding power supplies and fans that are covered for three (3) years).
6. K-Touch software is covered by a standard one (1) year warranty for software updates.
7. All Kramer passive cables are covered by a lifetime warranty.

Who is Covered

Only the original purchaser of this product is covered under this limited warranty. This limited warranty is not transferable to subsequent purchasers or owners of this product.

What Kramer Electronics Will Do

Kramer Electronics will, at its sole option, provide one of the following three remedies to whatever extent it shall deem necessary to satisfy a proper claim under this limited warranty:

1. Elect to repair or facilitate the repair of any defective parts within a reasonable period of time, free of any charge for the necessary parts and labor to complete the repair and restore this product to its proper operating condition. Kramer Electronics will also pay the shipping costs necessary to return this product once the repair is complete.
2. Replace this product with a direct replacement or with a similar product deemed by Kramer Electronics to perform substantially the same function as the original product. If a direct or similar replacement product is supplied, the original product's end warranty date remains unchanged and is transferred to the replacement product.
3. Issue a refund of the original purchase price less depreciation to be determined based on the age of the product at the time remedy is sought under this limited warranty.

What Kramer Electronics Will Not Do Under This Limited Warranty

If this product is returned to Kramer Electronics or the authorized dealer from which it was purchased or any other party authorized to repair Kramer Electronics products, this product must be insured during shipment, with the insurance and shipping charges prepaid by you. If this product is returned uninsured, you assume all risks of loss or damage during shipment. Kramer Electronics will not be responsible for any costs related to the removal or re-installation of this product from or into any installation. Kramer Electronics will not be responsible for any costs related to any setting up this product, any adjustment of user controls or any programming required for a specific installation of this product.

How to Obtain a Remedy Under This Limited Warranty

To obtain a remedy under this limited warranty, you must contact either the authorized Kramer Electronics reseller from whom you purchased this product or the Kramer Electronics office nearest you. For a list of authorized Kramer Electronics resellers and/or Kramer Electronics authorized service providers, visit our web site at www.kramerav.com or contact the Kramer Electronics office nearest you.

In order to pursue any remedy under this limited warranty, you must possess an original, dated receipt as proof of purchase from an authorized Kramer Electronics reseller. If this product is returned under this limited warranty, a return authorization number, obtained from Kramer Electronics, will be required (RMA number). You may also be directed to an authorized reseller or a person authorized by Kramer Electronics to repair the product.

If it is decided that this product should be returned directly to Kramer Electronics, this product should be properly packed, preferably in the original carton, for shipping. Cartons not bearing a return authorization number will be refused.

Limitation of Liability

THE MAXIMUM LIABILITY OF KRAMER ELECTRONICS UNDER THIS LIMITED WARRANTY SHALL NOT EXCEED THE ACTUAL PURCHASE PRICE PAID FOR THE PRODUCT. TO THE MAXIMUM EXTENT PERMITTED BY LAW, KRAMER ELECTRONICS IS NOT RESPONSIBLE FOR DIRECT, SPECIAL, INCIDENTAL OR CONSEQUENTIAL DAMAGES RESULTING FROM ANY BREACH OF WARRANTY OR CONDITION, OR UNDER ANY OTHER LEGAL THEORY. Some countries, districts or states do not allow the exclusion or limitation of relief, special, incidental, consequential or indirect damages, or the limitation of liability to specified amounts, so the above limitations or exclusions may not apply to you.

Exclusive Remedy

TO THE MAXIMUM EXTENT PERMITTED BY LAW, THIS LIMITED WARRANTY AND THE REMEDIES SET FORTH ABOVE ARE EXCLUSIVE AND IN LIEU OF ALL OTHER WARRANTIES, REMEDIES AND CONDITIONS, WHETHER ORAL OR WRITTEN, EXPRESS OR IMPLIED. TO THE MAXIMUM EXTENT PERMITTED BY LAW, KRAMER ELECTRONICS SPECIFICALLY DISCLAIMS ANY AND ALL IMPLIED WARRANTIES, INCLUDING, WITHOUT LIMITATION, WARRANTIES OF MERCHANTABILITY AND FITNESS FOR A PARTICULAR PURPOSE. IF KRAMER ELECTRONICS CANNOT LAWFULLY DISCLAIM OR EXCLUDE IMPLIED WARRANTIES UNDER APPLICABLE LAW, THEN ALL IMPLIED WARRANTIES COVERING THIS PRODUCT, INCLUDING WARRANTIES OF MERCHANTABILITY AND FITNESS FOR A PARTICULAR PURPOSE, SHALL APPLY TO THIS PRODUCT AS PROVIDED UNDER APPLICABLE LAW. IF ANY PRODUCT TO WHICH THIS LIMITED WARRANTY APPLIES IS A "CONSUMER PRODUCT" UNDER THE MAGNUSON-MOSS WARRANTY ACT (15 U.S.C.A. §2301, ET SEQ.) OR OTHER APPLICABLE LAW, THE FOREGOING DISCLAIMER OF IMPLIED WARRANTIES SHALL NOT APPLY TO YOU, AND ALL IMPLIED WARRANTIES ON THIS PRODUCT, INCLUDING WARRANTIES OF MERCHANTABILITY AND FITNESS FOR THE PARTICULAR PURPOSE, SHALL APPLY AS PROVIDED UNDER APPLICABLE LAW.

Other Conditions

This limited warranty gives you specific legal rights, and you may have other rights which vary from country to country or state to state.

This limited warranty is void if (i) the label bearing the serial number of this product has been removed or defaced, (ii) the product is not distributed by Kramer Electronics or (iii) this product is not purchased from an authorized Kramer Electronics reseller. If you are unsure whether a reseller is an authorized Kramer Electronics reseller, visit our web site at www.kramerav.com or contact a Kramer Electronics office from the list at the end of this document.

Your rights under this limited warranty are not diminished if you do not complete and return the product registration form or complete and submit the online product registration form. Kramer Electronics thanks you for purchasing a Kramer Electronics product. We hope it will give you years of satisfaction.



HDMI™
HIGH-DEFINITION MULTIMEDIA INTERFACE



P/N: 2900-301360



Rev: 1



SAFETY WARNING

Disconnect the unit from the power supply before opening and servicing

For the latest information on our products and a list of Kramer distributors, visit our website where updates to this user manual may be found.

We welcome your questions, comments, and feedback.

The terms HDMI, HDMI High-Definition Multimedia Interface, and the HDMI Logo are trademarks or registered trademarks of HDMI Licensing Administrator, Inc. All brand names, product names, and trademarks are the property of their respective owners.