



ClonerAlliance UHD Pro User Manual



ClonerAlliance UHD Pro User Manual

This documentation describes how to use ClonerAlliance UHD Pro (Model: CA-989UP) device.

Copyright Notice

Copyright © ClonerAlliance Inc. All rights reserved.

Documentation Version 1.0.0

No part of this publication may be reproduced, transmitted, transcribed, stored in a retrieval system, or translated into any language or computer language, in any form or by any means, electronic, mechanical, magnetic, optical, chemical, manual, or otherwise, without the prior written permission of ClonerAlliance Inc.

Trademarks

ClonerAlliance is a registered trademark of ClonerAlliance Inc.

Safety Notices

Before using ClonerAlliance UHD Pro, please ensure that you read and understand the safety precautions below:

1. Do not attempt to open the case of ClonerAlliance UHD Pro or modify it in any way, as this will void the warranty.
2. Keep ClonerAlliance UHD Pro away from water and other liquids, as this may cause the unit to malfunction.
3. ClonerAlliance UHD Pro may become warm during use. This does not indicate malfunction.
4. Do not place heavy objects on ClonerAlliance UHD Pro, as this may cause the unit to overheat and malfunction.
5. If the exterior of ClonerAlliance UHD Pro requires cleaning, wipe it with a soft dry cloth.
6. Do not dispose of the unit via conventional domestic waste.



HDCP

A large red prohibition sign (a circle with a diagonal cross) is overlaid on the right side of the "HDCP" text, indicating that HDCP is not supported or is prohibited.

Warning:

All ClonerAlliance products do NOT support to display or capture HDCP protected content.

According to the DMCA (Digital Millennium Copyright Act, 17 U.S.C. § 1201), it is illegal to bypass the HDCP protection by using HDMI capture devices.

If you violate the above laws, you may face a lawsuit.

CONTENTS

1	Getting Started	1
1.1	Box Contents	1
1.2	Product Diagram.....	2
1.3	Indicator Color Diagram.....	7
1.4	Remote Diagram.....	14
2	OSD Summary	15
2.1	DISPLAY	15
2.2	Settings Menu.....	16
3	Record videos to the USB storage device	25
3.1	Connect.....	25
3.2	Record videos	26
3.3	Take Snapshots	30
3.4	Record live commentary or voice-over	31
4	Playback the Recorded Media files	35
4.1	Playback the Recorded media files on ClonerAlliance UHD Pro directly.....	35
4.2	Playback the Recorded media files on TV	39
4.3	Playback/Edit the Recorded media files on PC	41
5	Schedule Recording	42
5.1	Set the system time.....	42
5.2	Set the schedule	43
6	Software Installation	44
6.1	Install and register ClonerAlliance Helper (Windows Users)	44

6.2	Install and register MP4-Cloner (Windows Users).....	48
6.3	Install VLC player (Windows, Mac, and Linux Users)	51
6.4	Install OBS Studio	52
7	Record and Trim/Combine/Convert videos on PC	54
7.1	Install Software.....	54
7.2	Record/Capture videos on PC.....	54
7.3	Trim video files on PC	60
7.4	Combine video files on PC.....	64
7.5	Convert video files on PC.....	67
8	Preview videos for live streaming	72
8.1	Connection Guide of ClonerAlliance UHD Pro.....	72
8.2	Install ClonerAlliance Helper or OBS Studio	72
8.3	Setting for live stream in ClonerAlliance Helper (Windows)	73
8.4	Setting for preview video in OBS studio	75
9	Frequently Asked Questions	80
10	Product Specifications	86
11	After Sales Warranty	87
12	Contact Us	88
13	Disclaimer	89

1.1 Box Contents

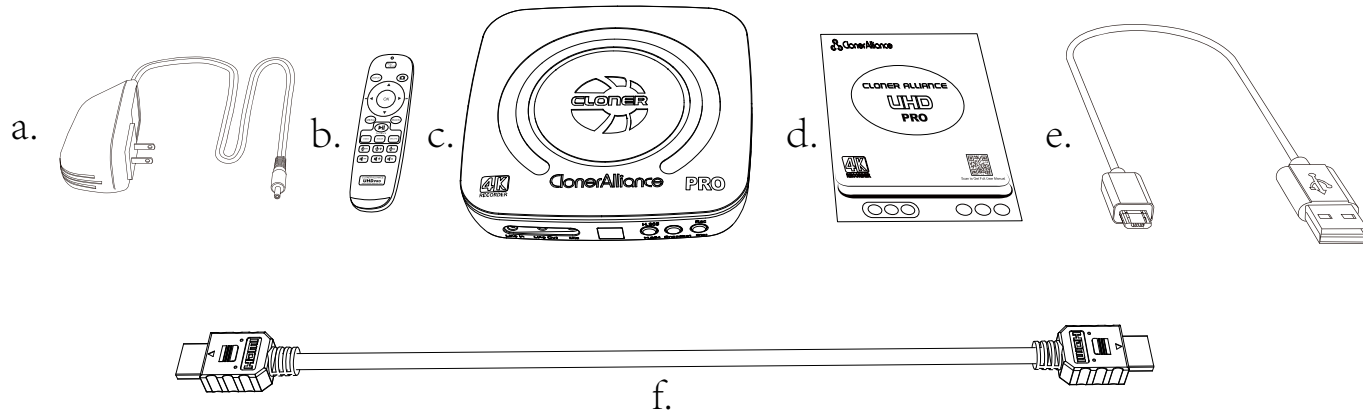

- a. Power Adapter
- b. Remote Control
- c. ClonerAlliance UHD Pro

- d. User Manual
- e. Micro B to USB cable
- f. HDMI cable

1.2 Product Diagram

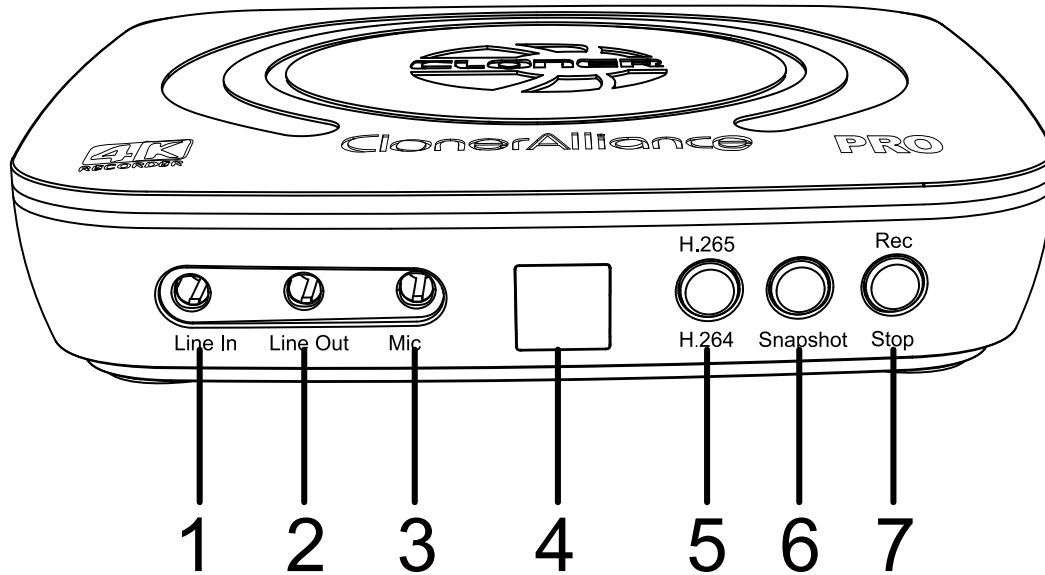

1. Line In: Stereo audio inputs.
2. Line Out: Insert the headphone plug into this jack to output the video sound.
3. Mic: Insert the microphone plug into this jack to input voice.
4. IR Window: Receives the IR signal from the remote control.
5. Switch button of H.264/H.265.
6. Snapshot button.
7. Rec/Stop button.

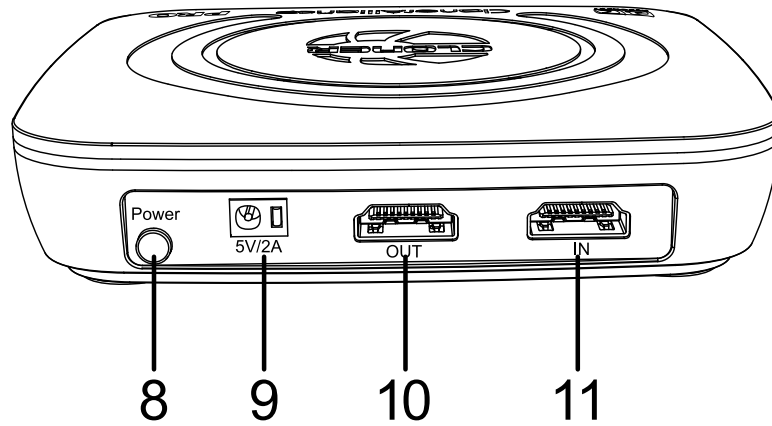

8. Power ON/OFF button.

9. Power socket of 5V/2A.

10. OUT: Connect an HDMI cable between ClonerAlliance UHD Pro and TV.

11. IN: Connect an HDMI cable between the video player and ClonerAlliance UHD Pro.

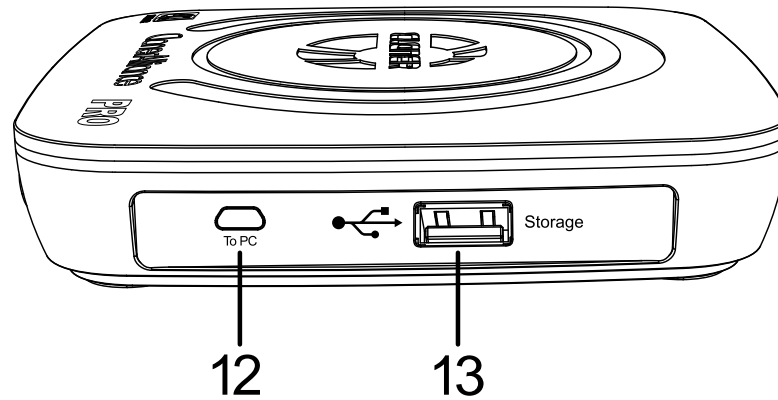

12. To PC: Connect the Micro-USB to USB cable between PC and ClonerAlliance UHD Pro for recording videos to PC.
Tip: This function above must be realized with software. For Windows system, please use ClonerAlliance Helper/OBS etc, For Mac/Linux system, please use OBS.
13. Storage: Insert a USB flash drive or mobile hard disk and record videos to this storage medium.

1.3 Indicator Color Diagram

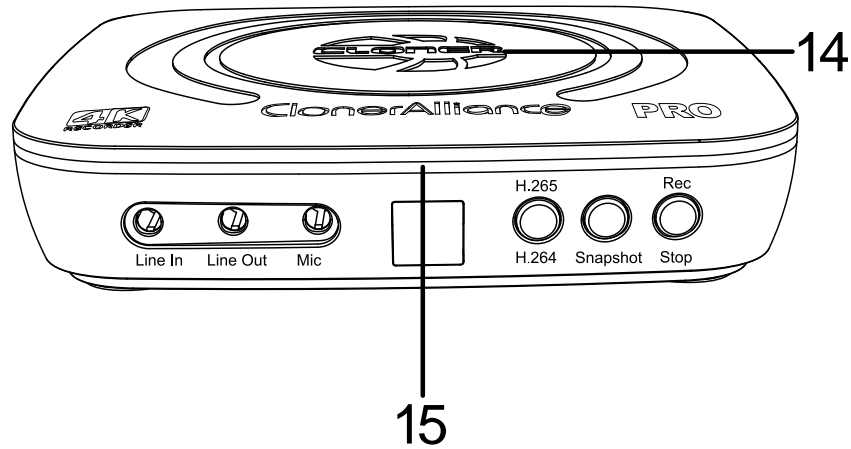

14. Top indicator.

15. Side indicator.

1. Top indicator

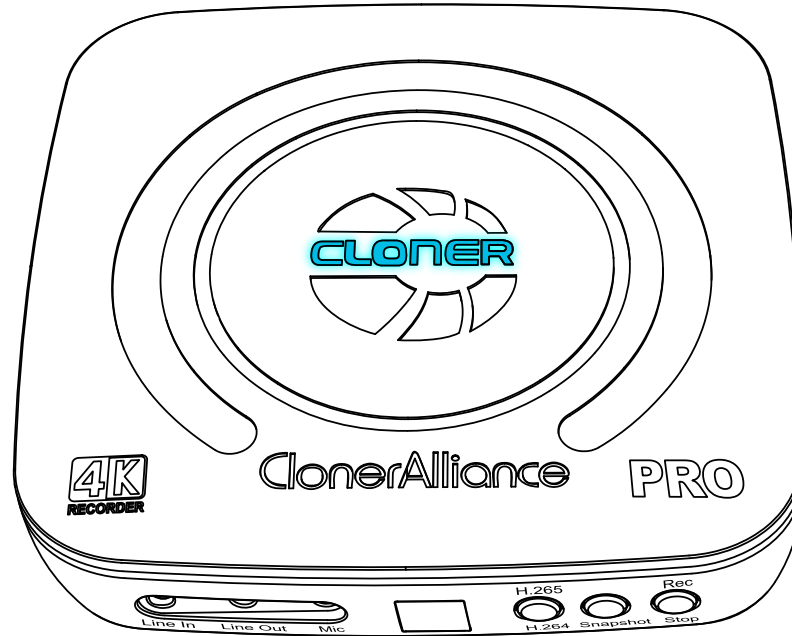

- Color: Stable BLUE
- Status: Output and Recording Resolution is 4K@30Hz

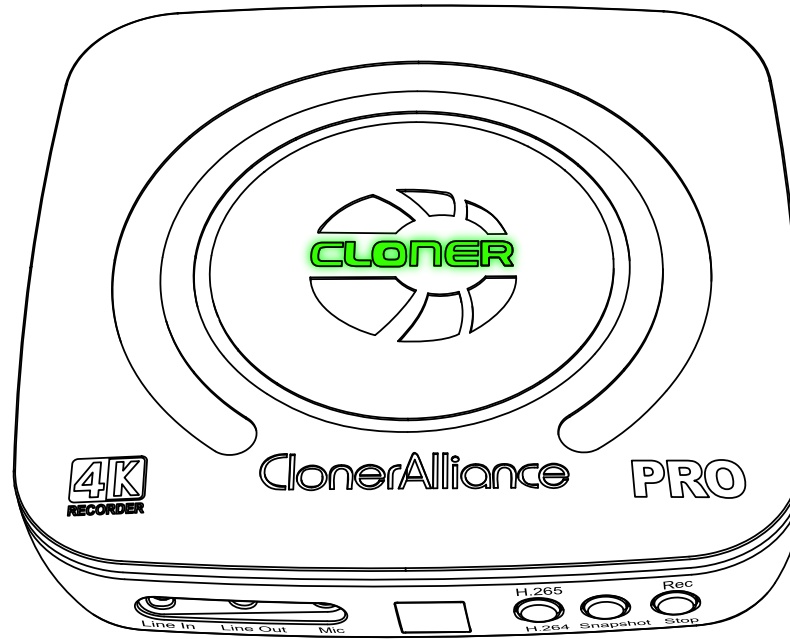

- Color: Stable GREEN
- Status: Output and Recording Resolution is 1080p@60Hz or Below

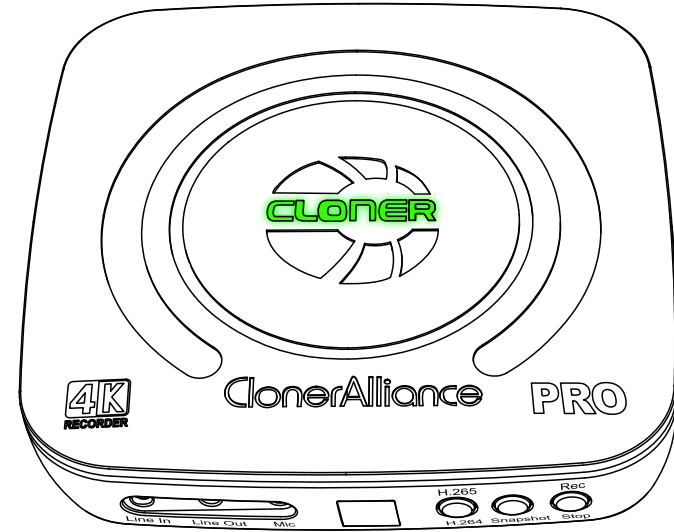
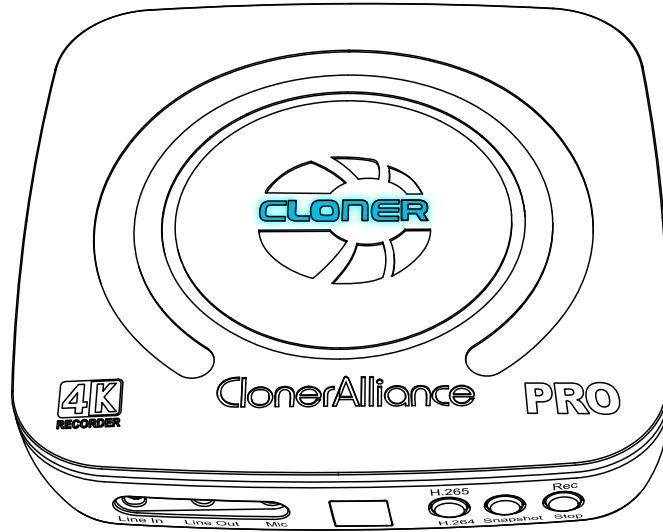

- Color: Blink BLUE&GREEN Alternately
- Status: No Input/Unsupported Input

2. Side Indicator

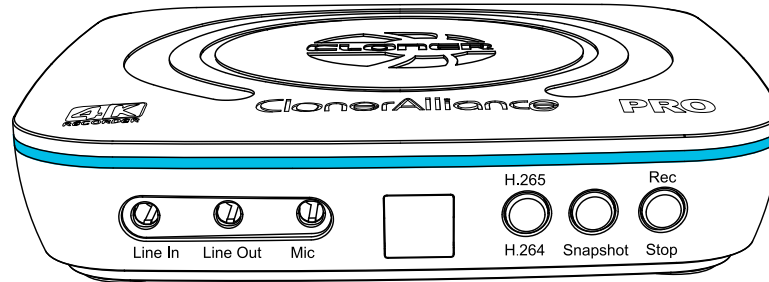

- Color: Stable BLUE
- Status: Encoding Format is H.264

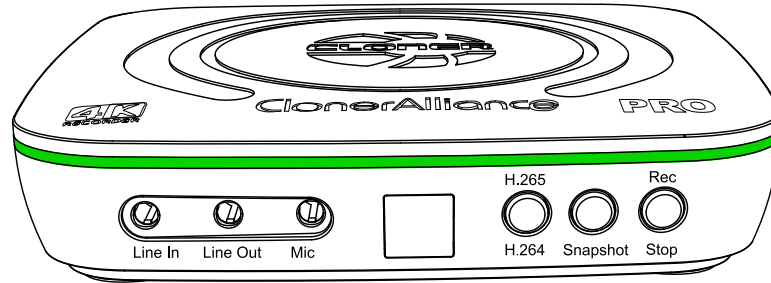



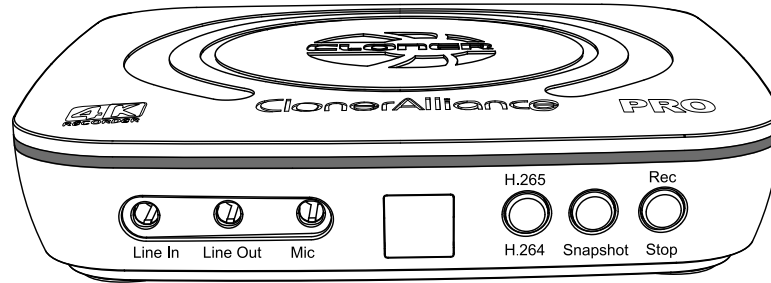





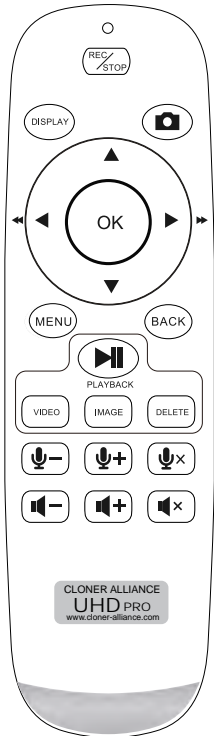









- Color: Stable GREEN
- Status: Encoding Format is H.265



- Color: OFF
- Status: No Storage Device Connected

1.4 Remote Diagram



	REC/STOP.
	DISPLAY.
	Snapshot.
	OK button.
	Up arrow.
	Down arrow.
	Left arrow.
	Right arrow.
	Menu.
	Back button.
	Start or stop playing.
	Video playback.
	Image playback.
	Delete recorded files.
	Volume down for Mic.
	Volume up for Mic.
	Mute or unmute for Mic.
	Volume down.
	Volume up.
	Mute or unmute for audio output.

Tips: The remote control is powered by 2 AAA batteries which are not included and need to be purchased independently.

2.1 DISPLAY

Please press  button on remote to display media information OSD.

- Display OSD



2.2 Settings Menu

Please press  button on remote to display settings menu.

- Show up the Settings Menu



1. Record settings



- **Format**

- H.264 (AVC)
- H.265 (HEVC)

- **Bitrate**

- **Bitrate set to Low**

- * H.264: UHD 16Mbps, FHD 12Mbps, HD 8Mbps, SD 4Mbps
- * H.265: UHD 12Mbps, FHD 8Mbps, HD 6Mbps, SD 4Mbps

- **Bitrate set to High**

- * H.264: UHD 20Mbps, FHD 16Mbps, HD 12Mbps, SD 8Mbps

* H.265: UHD 16Mbps, FHD 12Mbps, HD 8Mbps, SD 4Mbps

The bitrate can be set, the compression bitrate is related to the video compression format and resolution.

- **Always display REC**
 - ON: It will always display “REC” during recording.
 - OFF: “REC” only shows up at the beginning of recording, and will disappear in a few seconds
- **File size**
 - 16GB/3H: Single file max size up to 16GB or 3 hours
 - 2GB/3H: Single file max size up to 2GB or 3 hours
 - 4GB/3H: Single file max size up to 4GB or 3 hours

TIP: Using FAT32 USB storage devices, the single recorded file will be 4GB at most due to the limitation of FAT32 format.

- **Time Watermark**
 - ON: It will display time watermark during recording.
 - OFF: No time watermark displayed on screen.
- **Loop recording**
 - ON: Enable loop recording. Under this setting, when the USB storage device is full, it will keep recording and previous files will be overwritten.
 - OFF: Disable loop recording. Under this setting, when the USB storage device is full, it will stop recording automatically.

2. Schedule settings



- **Schedule**
 - ON: Enable schedule recording.
 - OFF: Disable schedule recording.

- **Schedule mode :**
 - Once
 - Every Day
- **Time ranges** Max task number is up to 3

3. System settings

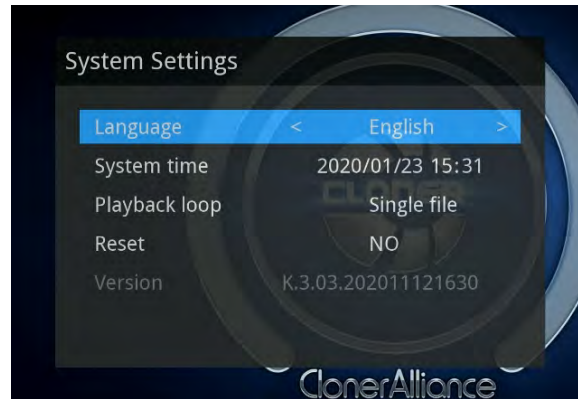

- **Language**
 - English
 - Simplified Chinese.
- **System time**
 - yyyy-mm-dd hh-mm
- **Playback loop**

- Single file: Play a single file in a loop.
- Full list: Play the whole file list in a loop.
- OFF: Disable playback loop function.
- **Reset** Restore Factory Default Settings.
- **Version** Firmware version is only for developers' references.

4. Video playback

After recording, make sure USB flash drive is connected to ClonerAlliance UHD PRO. Press MENU button on remote and select “Video playback” or press VIDEO button on remote to enter “Video playback” interface directly.



Choose the file you want to play back by using the four arrow buttons on the remote control, and press PLAYBACK button on remote to start/pause playback. You also can enter fullscreen by pressing OK button on the remote control.



5. Photo playback

ClonerAlliance UHD PRO supports photo playback, please press MENU button on remote and select “Photo playback” or press IMAGE button on remote to enter “Photo playback” interface directly.



Select the photo you desired by using the four arrow buttons on the remote control. It will display fullscreen by pressing OK button.



RECORD VIDEOS TO THE USB STORAGE DEVICE

3.1 Connect

1. Connect the video player to IN port on ClonerAlliance UHD Pro via an HDMI cable.
2. Connect ClonerAlliance UHD Pro from OUT port to TV via an HDMI cable.
3. Plug the USB storage device into ClonerAlliance UHD Pro.
4. Plug the power adapter into the power socket and plug the other end into the 5V/2A port of ClonerAlliance UHD Pro.
5. Power on ClonerAlliance UHD Pro after all devices and cables are well connected.



Tips:

Please use a premium USB flash drive or mobile hard disk with high speed to avoid unexpected problems such as file loss.

3.2 Record videos

You can select to use the function buttons on ClonerAlliance UHD Pro to record or use the remote of ClonerAlliance UHD Pro to record. Please check out details below.

- Record videos with the buttons on the front panel of ClonerAlliance UHD Pro
 1. Power on all devices, the video image from the video player will be displayed on TV and the LED will illuminate solid blue or solid green. Solid blue indicates the output resolution is 4K30 and solid green indicates the output resolution is 1080p60 or below. If the top LED is blinking blue and green alternately, that indicates there is no input signal detected.
 2. Before recording, you can easily switch to H.264 or H.265 by pressing H.264/H.265 button on the front panel of ClonerAlliance UHD Pro. This option should be done with USB storage device connected to ClonerAlliance UHD Pro.
 3. Press the Rec/Stop button on ClonerAlliance UHD Pro, then the LED will blink blue or green, which indicates ClonerAlliance UHD Pro is in the process of recording.



4. Press the Rec/Stop button again on ClonerAlliance UHD Pro, then the LED will blink blue/green alternately, which indicates the recorded video is being saved.
 5. When the LED turns solid blue or solid green from blinking blue/green alternately, it indicates the video has been saved successfully.
 6. You can playback the recorded files on ClonerAlliance UHD Pro directly or on PC or on a smart TV.
- Record videos with the remote included with ClonerAlliance UHD Pro

1. Power on all devices, the video image from the video player will be displayed on TV and the LED will illuminate solid blue or solid green. Solid blue indicates the output resolution is 4K30 and solid green indicates the output resolution is 1080p60 or below. If the top LED is blinking blue and green alternately, that indicates there is no input signal detected.
2. Before recording, you can easily switch to H.264 or H.265 by pressing H.264/H.265 button on the front panel of ClonerAlliance UHD Pro. This option should be done with USB storage device connected to ClonerAlliance UHD Pro.



3. Press the Rec/Stop button on the Remote of ClonerAlliance UHD Pro, then the LED will blink blue or green, which

indicates the capture box is in the process of recording.

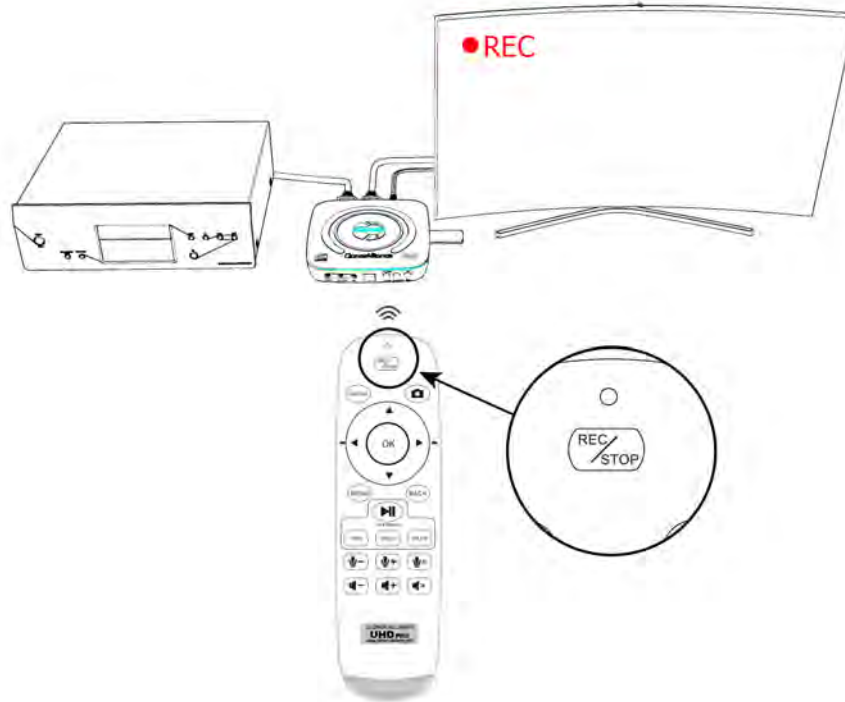

4. During recording process, you can adjust the volume of HDMI IN at any time. If you got Mic connected, you also can adjust the volume of Mic during recording by pressing the volume up/down button on the Remote.

5. Press the Rec/Stop button again on the Remote, then the LED will blink blue/green alternately, which indicates the recorded video is being saved.
6. When the LED turns solid blue or solid green from blinking blue/green alternately, it indicates the video has been saved successfully.
7. You can playback the recorded files on ClonerAlliance UHD Pro directly or on PC or on a smart TV.

Note: DO NOT remove the USB storage drive from ClonerAlliance UHD Pro in the process of recording (Flashing Blue/Green LED indicates it's still in the process of recording.)

3.3 Take Snapshots

1. Using the Remote included with ClonerAlliance UHD Pro to take a snapshot.

Press  on the remote control to take a snapshot.

2. Using the buttons on the front panel of ClonerAlliance UHD Pro.

Press “Snapshot” button on the front panel of ClonerAlliance UHD Pro to take a snapshot.

You can playback the snapshots on ClonerAlliance UHD Pro directly or on PC or on smart TV.

3.4 Record live commentary or voice-over

ClonerAlliance UHD Pro can capture and mix dual audio channels coming from game console and your microphone. Capture your live commentary with the microphone jack, which is built into ClonerAlliance UHD Pro. Plug a microphone and then capture your gameplay with your live voice!

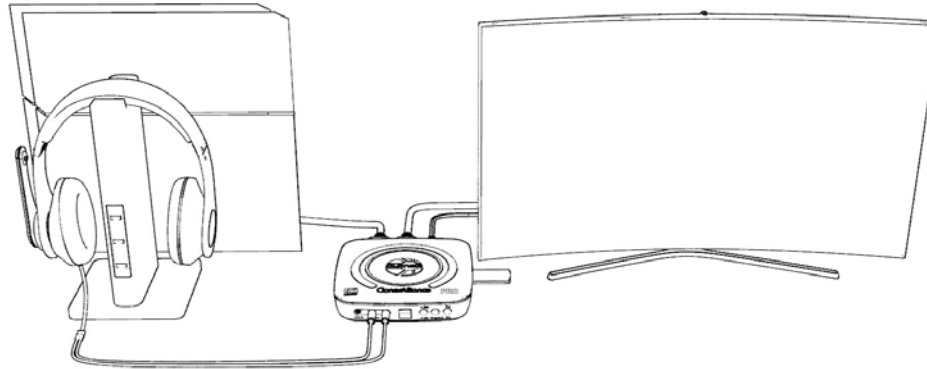

- Connect MIC

It is compatible with most 3.5mm audio standard MICs, you can mix your voice into source video.

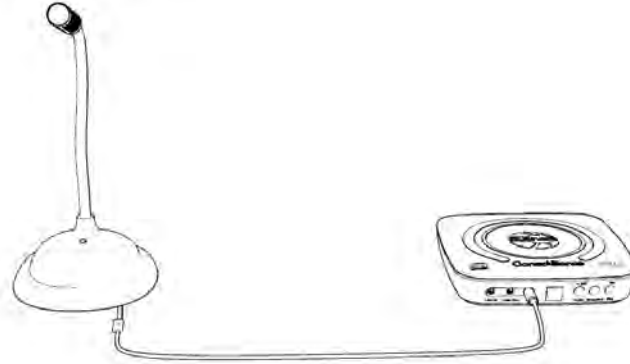

It will be shown in display OSD as “MIC ON”



- Connect Line in

Line in socket is compatible with 3.5mm audio connector, such as audio mix device, mp3 players and cell phones.

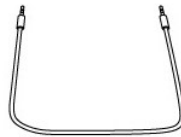

You can easily mix audio via “Line in” by using 3.5mm audio cable connected to audio devices.

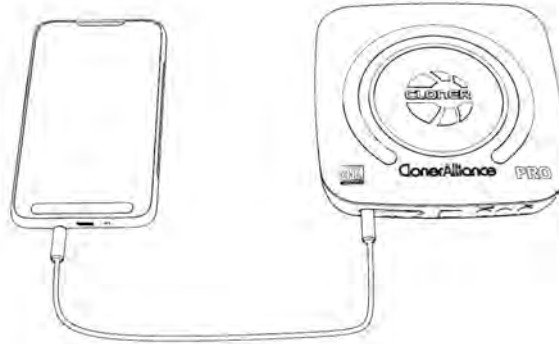

After connected audio device to “Line in” , it will directly mix audio to HDMI embedded audio. It also can be monitored from “Line out” and output devices.

- Adjust Mic volume using the Remote

You can press volume up/down button on the Remote control of ClonerAlliance UHD Pro to adjust the volume of Mic.

The up/down buttons on the Remote control: 

PLAYBACK THE RECORDED MEDIA FILES

4.1 Playback the Recorded media files on ClonerAlliance UHD Pro directly

- Connect

1. Connect the video player to “In” port on ClonerAlliance UHD Pro via an HDMI cable.
2. Connect ClonerAlliance UHD Pro from “Out” port to TV via an HDMI cable.
3. Plug the USB storage device into the “Storage” port of ClonerAlliance UHD Pro.
4. Plug the power adapter into the power socket and plug the other end into the 5V/2A port of ClonerAlliance UHD Pro.



After all devices are connected properly, plug the USB storage device into ClonerAlliance UHD Pro and press the “VIDEO” or “IMAGE” button on the remote control to enter the playback menu interface. You will see the file list.

- Video playback



- Image playback



- Fullscreen playback

Select your desired file by using the four arrow buttons on the remote control. You can preview the files and press “OK” button to fullscreen playback.



- ATTENTION

If you got similar situations as below, Please click [here](#) to reformat your USB external hard drive, the issue can be fixed immediately.

1. When using ClonerAlliance UHD Pro, you cannot use the remote to playback the recorded video after recording. To be more specific, you can use ClonerAlliance UHD Pro to record videos successfully, but you can't playback it with the remote.
2. During the process of recording, ClonerAlliance UHD Pro stops recording abnormally.

- Quick solutions

If you got problems in the process of playback, Please try the steps below:

1. Please make sure that your USB stick/external hard drive works well. You can change another one to confirm it or format it to resolve it.
2. Please adjust resolution to test again.
3. If the methods don't work, refer to the link above to format your USB stick/external hard drive to fix it.

4.2 Playback the Recorded media files on TV

- Connect

1. Plug the USB flash drive to the USB socket of a smart TV which has built-in media file playback function.
2. Power on the smart TV

- Steps

1. After files are successfully saved to USB flash drive, plug the USB flash drive to the USB socket of a smart TV which has built-in media file playback function.



2. Launch USB device on smart TV, then playback the files ClonerAlliance UHD Pro recorded.



4.3 Playback/Edit the Recorded media files on PC

- Connect

1. Plug the USB flash drive to the USB socket of PC.
2. Launch USB flash drive on PC.

- Steps:

1. Playback the recorded video files with VLC media player.

Please download VLC media player software and install it on your PC first.

See details about *Install VLC player (Windows, Mac, and Linux Users)*

2. Edit the recorded video files with MP4-Cloner

Please download MP4-Cloner software and install it on your PC first.

See details about *Install and register MP4-Cloner (Windows Users)*

5.1 Set the system time

Press the MENU button on the remote control. Select System settings in the OSD menu. Set the system time by using the four arrow buttons on the remote control. Then press BACK on the remote to finish the setting.

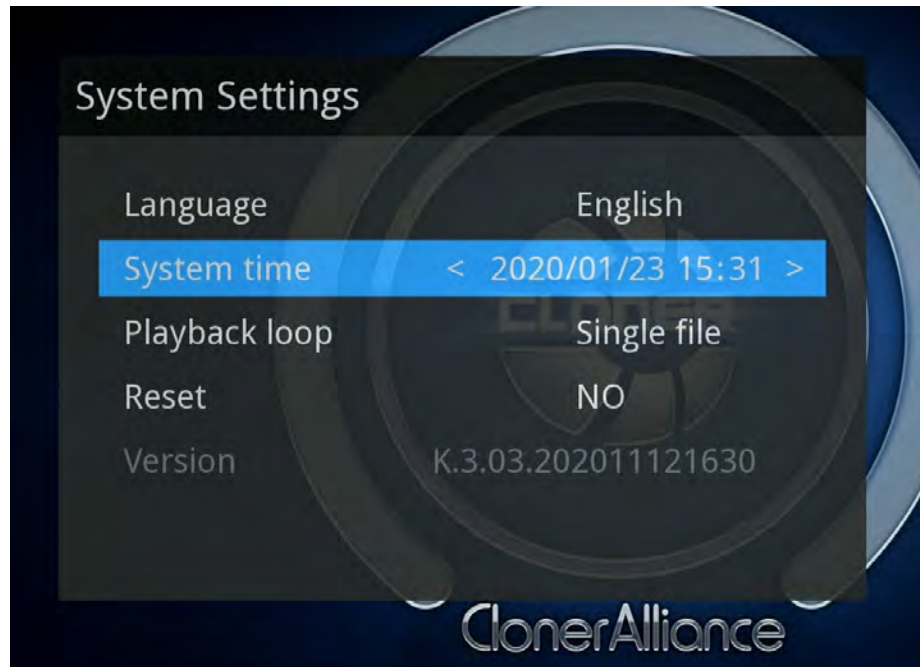

5.2 Set the schedule

Set the schedule mode, start time and finish time by using the four arrow buttons on the remote control. Then press BACK button on remote, it will save the scheduled tasks automatically.

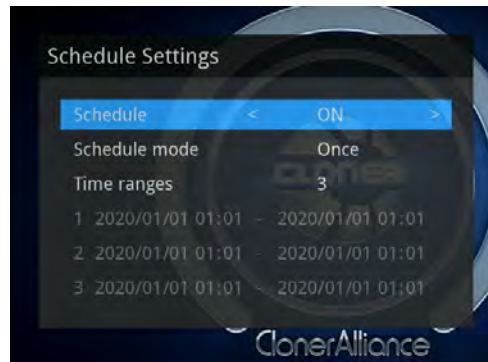

Then ClonerAlliance UHD Pro will start to record videos automatically at the scheduled time.

Note: If you want to record certain TV channel' s video, do select the TV channel first.

SOFTWARE INSTALLATION

6.1 Install and register ClonerAlliance Helper (Windows Users)

1. Install ClonerAlliance Helper

Note: Prior to installing ClonerAlliance Helper, please make sure you are using Windows 7 or later versions and your PC is equipped with USB 2.0 or 3.0 port.

- Download ClonerAlliance Helper software from <https://static.cloner-alliance.com/download/cloneralliance-helper.exe>
- Double click the installation file and the setup wizard window will pop up. Follow the installation wizard to complete the installation process. You do not have to restart your computer after the installation is complete.

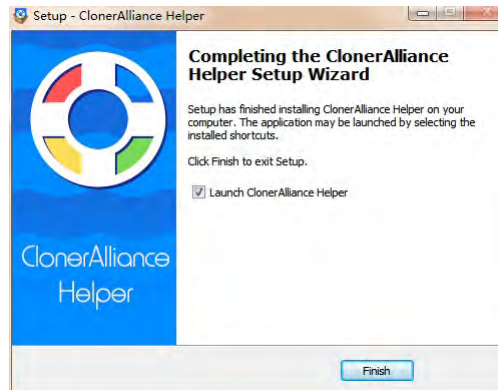

- Connect ClonerAlliance UHD Pro with other devices.

1. Connect the video player to the In port on ClonerAlliance UHD Pro via an HDMI cable.
2. Plug the power adapter into the power socket and plug the other end into the 5V/2A port of ClonerAlliance UHD Pro.
3. Connect the Micro-USB to USB cable between the “To PC” port of ClonerAlliance UHD Pro and the USB port of PC.

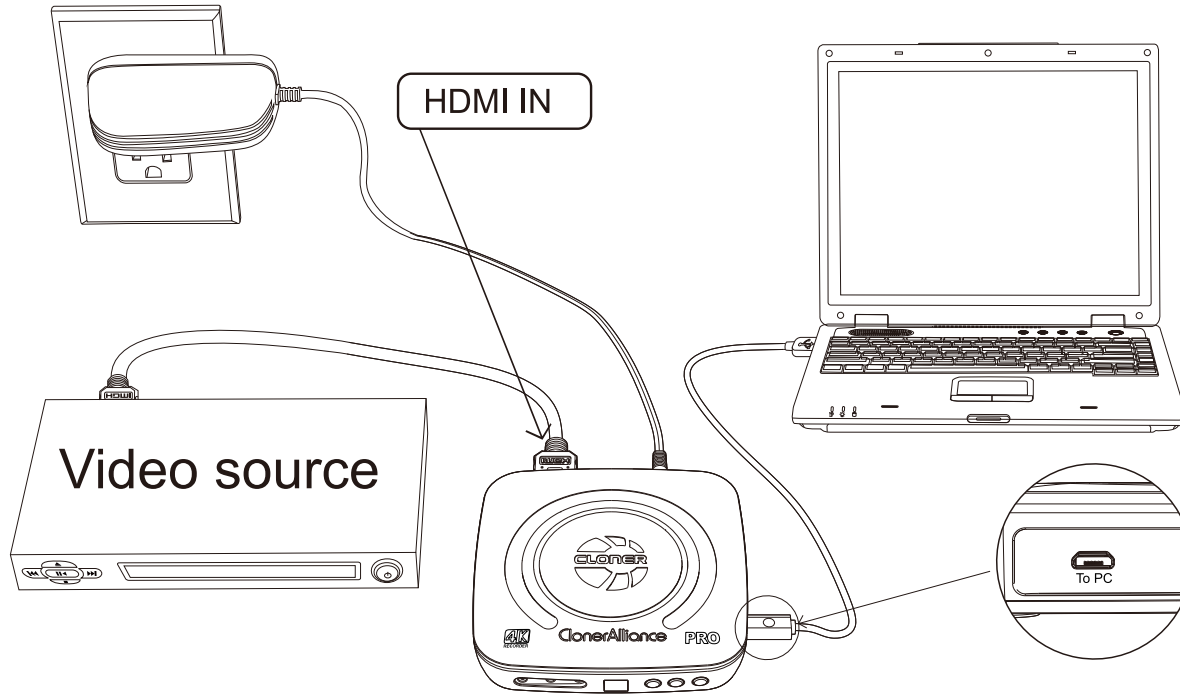

After all devices have been connected properly, please power on all connected devices. The Windows operating system will prompt “Found a new hardware” and install the driver automatically. Please make sure ClonerAlliance UHD PRO is installed successfully and “CA-989UP UAC/UVC” appears in the Device Manager (Right click My Computer – Manage – System Tools – Device Manager). If “CA-989UP UAC/UVC” doesn’t appear in the list, please re-connect ClonerAlliance UHD Pro and try again.

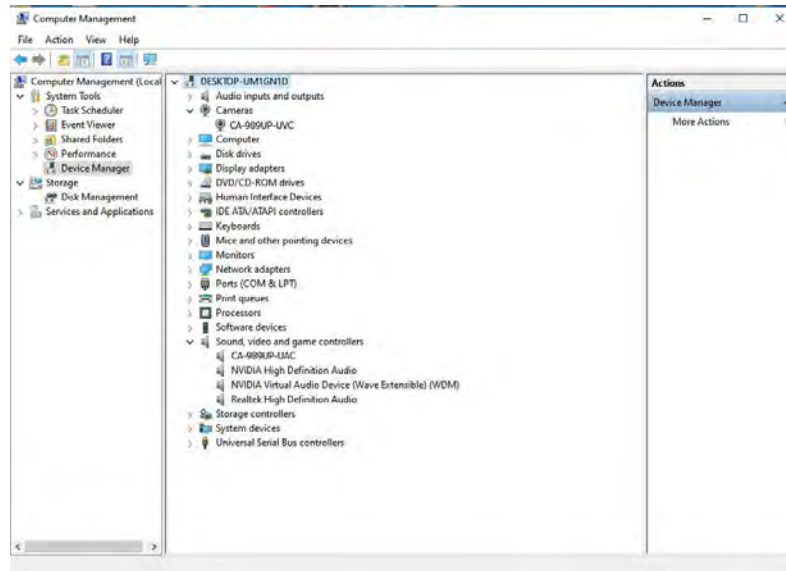

2. Register ClonerAlliance Helper

Please register ClonerAlliance Helper first before using, otherwise it can only be used for 7 days. Launch ClonerAlliance

Helper. Click "Input registration code" button in the auto pop-up Register window. Fill in your proper Email address, real name and code. Then click "OK" to finish the registration.

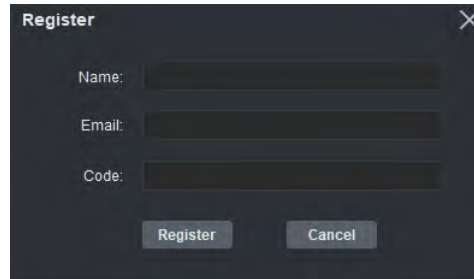
A dark-themed dialog box titled "Register" with a close button (X) in the top right corner. It contains three input fields labeled "Name:", "Email:", and "Code:". Below the fields are two buttons: "Register" and "Cancel".

Scan the QR code below or visit <https://www.cloner-alliance.com/register/> to get your registration code of ClonerAlliance Helper. The S/N of ClonerAlliance UHD Pro is in the form of CXXXXXXXXX.



(a)
[Click Here](#)

A promotional banner with a white background. On the left, it says "Do not miss out" in bold, followed by "Scan QR code to register and get FREE bundled softwares." Below this is the URL "www.cloner-alliance.com/register". In the center, there are four QR codes arranged in a 2x2 grid. On the right, there is a barcode with the text "S/N: CXXXXXXXXX" below it.

For more details about registering ClonerAlliance Helper, visit [here](#) to read step by step instructions.

6.2 Install and register MP4-Cloner (Windows Users)

1. Install MP4-Cloner

MP4-Cloner is a versatile program to edit MP4 video files recorded with our video capture tool. It enables you to trim, combine, convert and burn your MP4 videos.



- Download MP4-Cloner software from <https://static.cloner-alliance.com/download/mp4-cloner.exe>
- Double click the installation file and the setup wizard window will pop up. Follow the installation wizard to complete the installation process.



Note: Prior to installing MP4-Cloner, please make sure you are using Windows 7 or later versions and your PC is equipped with USB 2.0 or 3.0 port.

2. Register MP4-Cloner

Once ClonerAlliance Helper is registered successfully, then MP4-Cloner will be registered automatically at the same time

(Click on the “i” button of MP4-Cloner, and you can check the registration information).



For more details about registering bundled software of ClonerAlliance products, visit [here](#) to read step by step instructions.

6.3 Install VLC player (Windows, Mac, and Linux Users)

VLC is a free and open source cross-platform multimedia player and framework that plays most multimedia files as well as DVDs, Audio CDs, VCDs, and various streaming protocols. Download and start streaming quickly and easily on Windows, Mac or Linux.

Please install VLC and run it on your computer.

Tip: You can click [here](#) to download VLC.

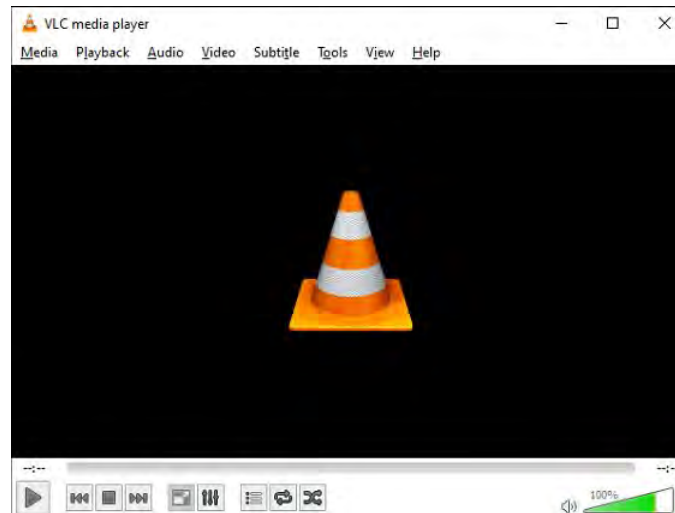

6.4 Install OBS Studio

Please install Open Broadcaster Software (OBS Studio) and run it on your computer. If you are Mac/Linux users, please download OBS Mac/Linux version accordingly.

Tip: You can click [here](#) to download Open Broadcaster Software (OBS Studio).

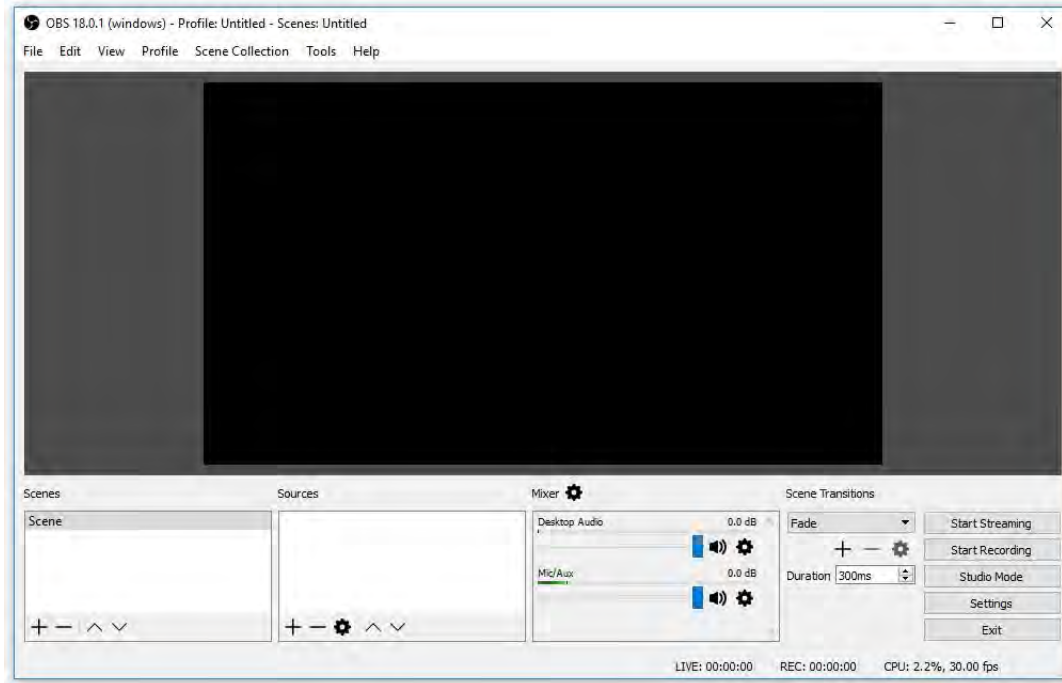

RECORD AND TRIM/COMBINE/CONVERT VIDEOS ON PC

7.1 Install Software

- **ClonerAlliance Helper** Please download ClonerAlliance Helper software and install it on your PC first. See details about *Install and register ClonerAlliance Helper (Windows Users)*
- **MP4-Cloner** Please download MP4-Cloner software and install it on your PC first. See details about *Install and register MP4-Cloner (Windows Users)*

7.2 Record/Capture videos on PC

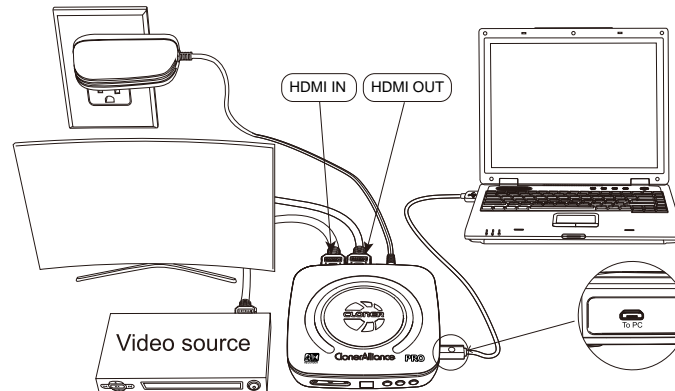

1. After all devices are connected properly, power on the video source device and launch ClonerAlliance Helper on PC.







2. Click  to start recording.



Software interfaces may vary depending on the version.

3. Click  to stop recording.

Tip: During recording, you can also click  to pause at anytime. When you want to resume, please click  to continue recording. Besides, you can Click  to take screenshots, click  to capture GIF animation.



4. After recording, click  to view the captured files, then double click the files to play back directly.

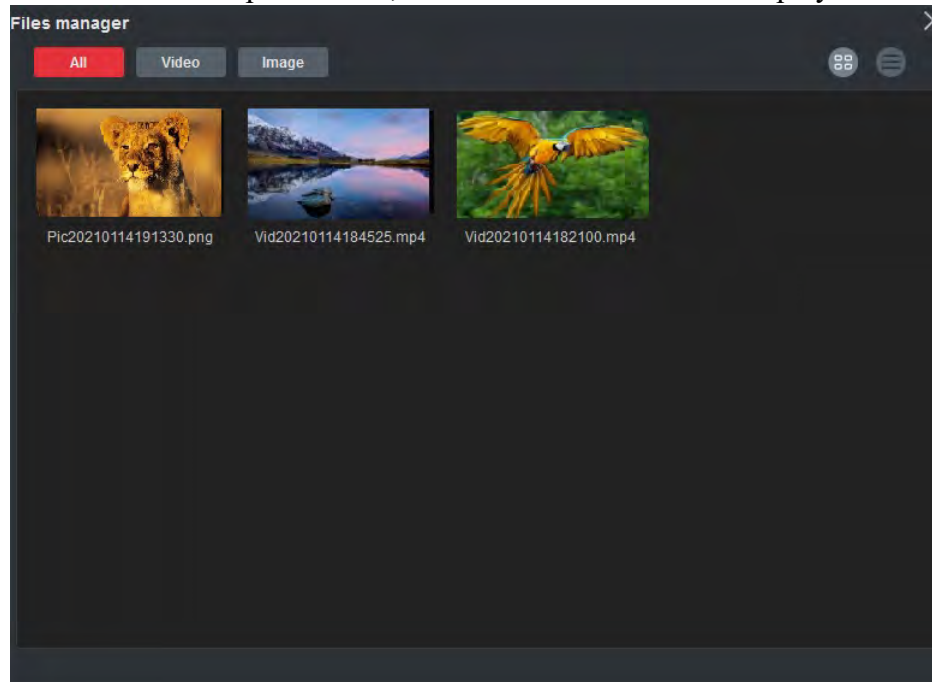

5. ClonerAlliance Helper also supports recording videos at the scheduled time. Click [Recording schedule](#) to enter the "Setup" window. Then click the "+" button.

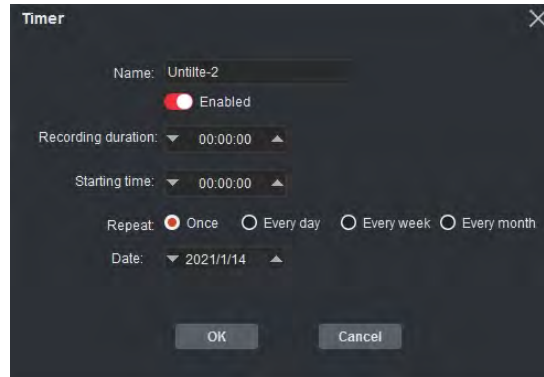

Please enable schedule recording first, and set the recording duration, starting time and repeat mode for schedule recording. Then click "OK". Then videos will be recorded automatically at the scheduled time.

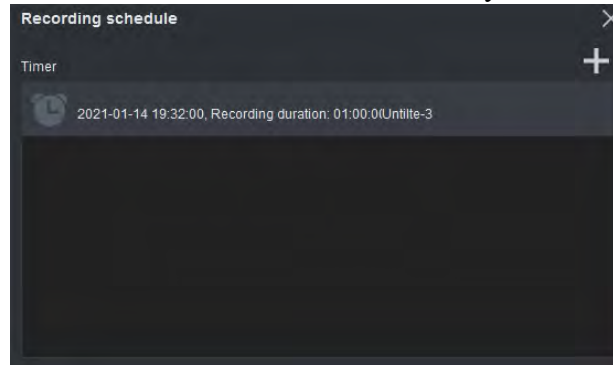

7.3 Trim video files on PC

- **Step 1:** Launch MP4-Cloner and click on the “Trim” button.



- **Step 2:** Click on the “Add” button to add a MP4 video. Set the start and end time and then click on the “Start”

button.



- **Step 3:** Affirm the configuration. Click on the “Browse” button to set the video name and saving path. You can choose the audio codec from Keep AAC, AC3 and MP3.



- **Step 4:** It will start trimming.

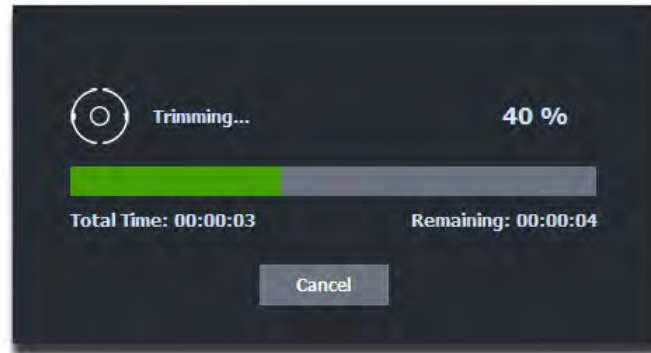

- **Step 5:** Completed!

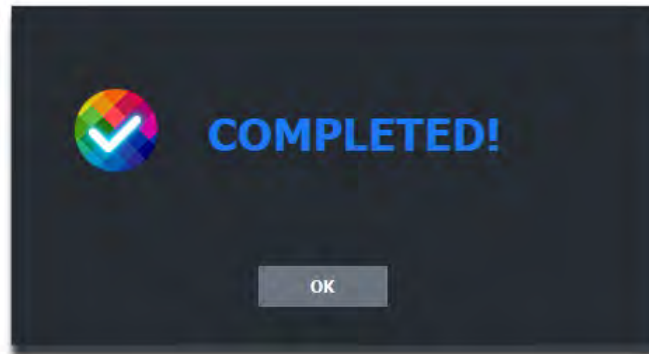

7.4 Combine video files on PC

- **Step 1:** Launch MP4-Cloner and click on the “Combine” button.



- **Step 2:** Click on the “Add” button to add at least two MP4 videos to the list and click on the “Browse” button to

set the video name and saving path. Then select the audio codec from AAC, AC3 and MP3 and then click on the “Start” button.

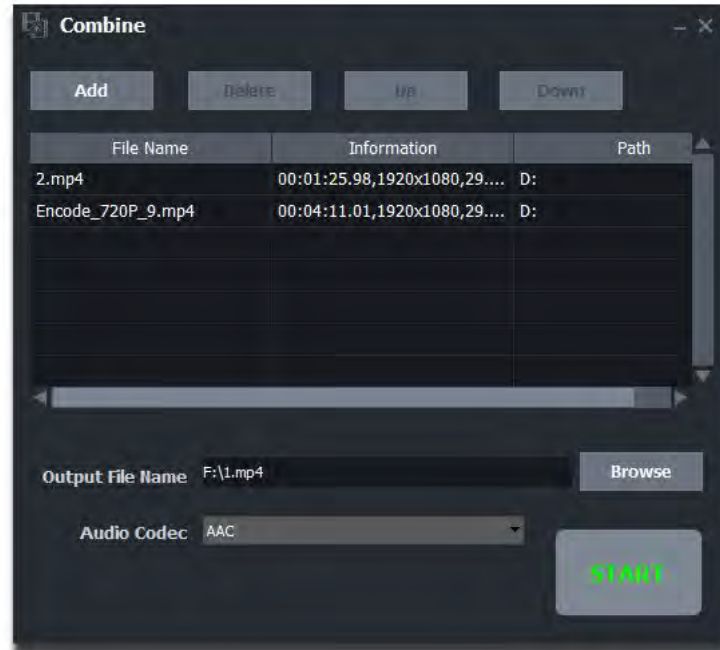

- **Step 3:** It will start combining.

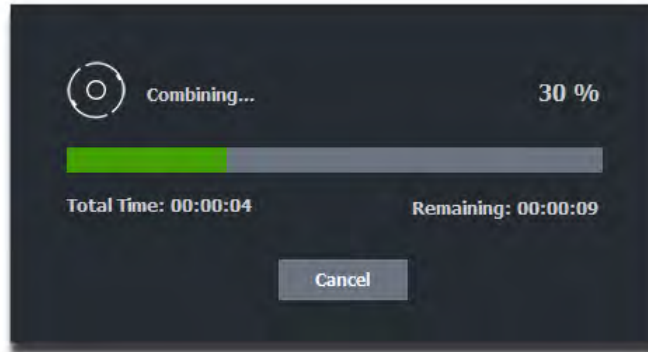

- **Step 4: Completed!**

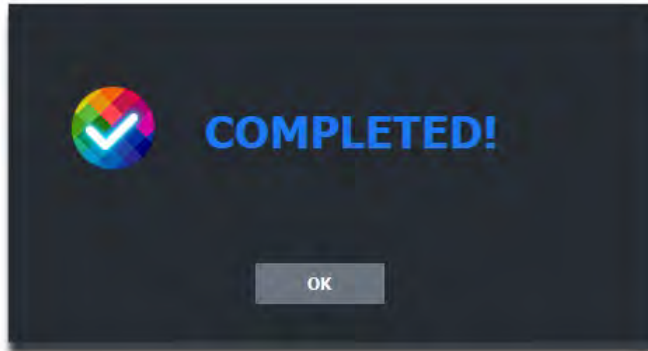

7.5 Convert video files on PC

- **Step 1:** Launch MP4-Cloner and click on the “Convert” button.



- **Step 2:** Click on the “Add File(s)” button to add one or more MP4 videos to the list and then click on the “Next”

button.

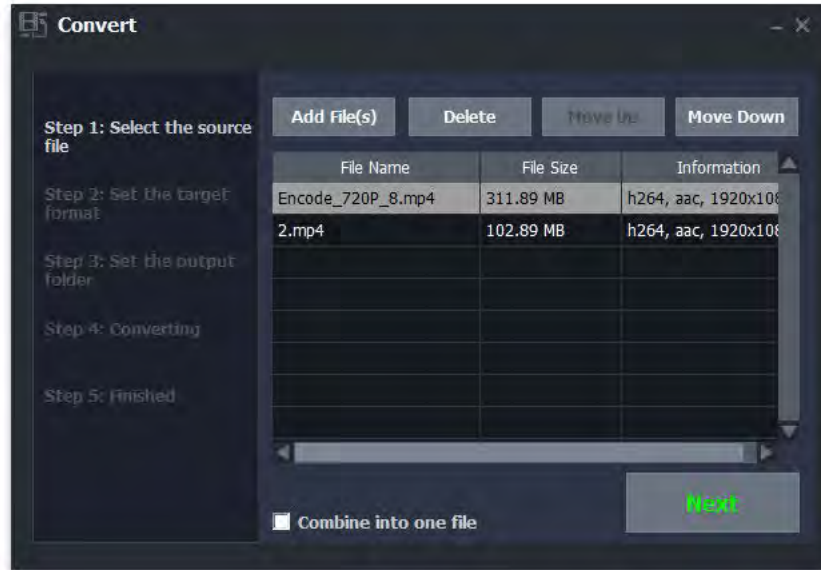

Note: If you add two or more MP4 videos, the option “Combine into one file” at the bottom will be available. This feature enables you to combine the converted videos into one video. You can select to use it or just ignore it.

- **Step 3:** Set the target format. You can set the parameters here and then click on the “Next” button.

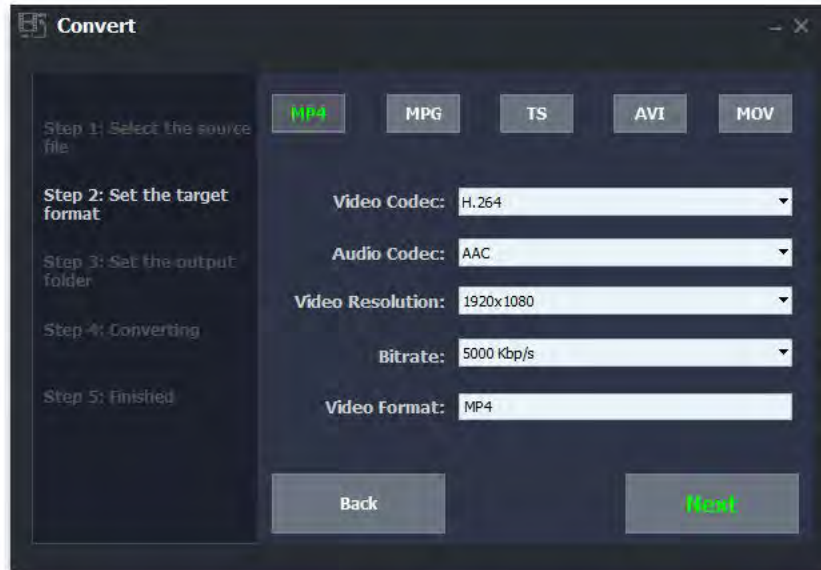

- **Step 4:** Set the output folder. Click on the “Browse” button to choose the video saving path and then click on the “Start” button.

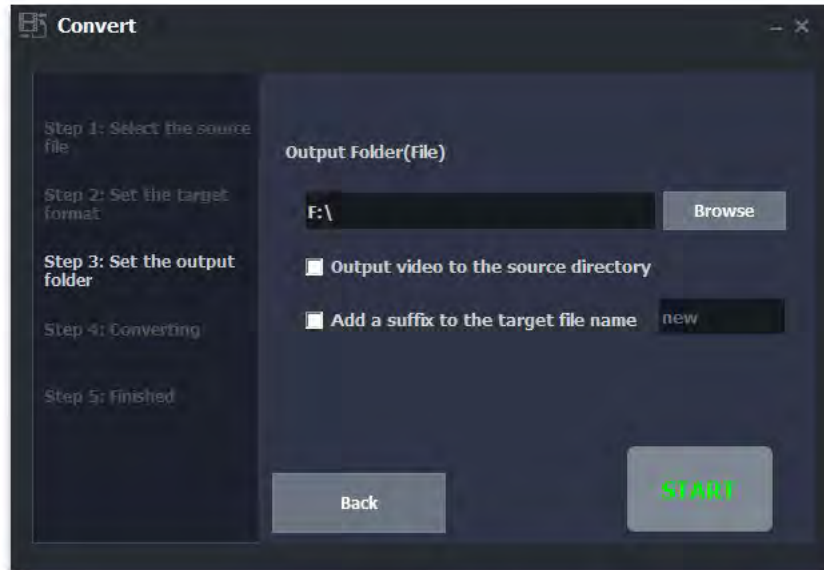

Note: On this window, there is an option “Output video to the source directory” . If you check this option, the video will be saved to the source directory. To avoid the same file name, the option “Add a suffix to the target file name” will be also checked automatically to differentiate the target video and source video.

- **Step 5:** It will start converting.

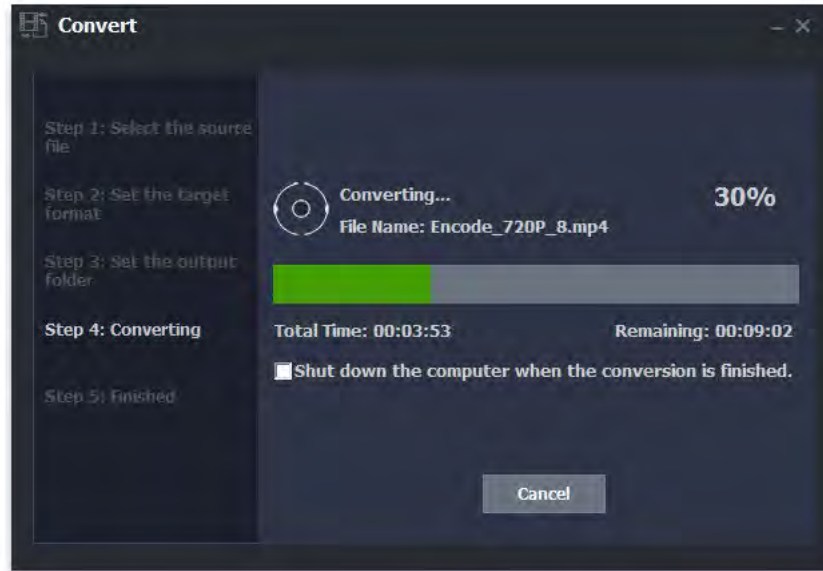

Note: If you’ d like to shut down your computer after the conversion is completed, please close all the other programs and select “Shut down the computer when the conversion is finished” .

- **Step 6:** Completed!

PREVIEW VIDEOS FOR LIVE STREAMING

You can use ClonerAlliance UHD Pro in ClonerAlliance Helper to preview/record/livestream videos, or you can also use OBS Studio, which is a popular open source software for video recording and live streaming.

8.1 Connection Guide of ClonerAlliance UHD Pro

1. Connect the video player to IN port on ClonerAlliance UHD Pro via an HDMI cable.
2. Connect the Micro-USB to USB cable between the “To PC” port and the USB port of PC.
3. Plug the power adapter into the power socket and plug the other end into the 5V/2A port of ClonerAlliance UHD Pro.

8.2 Install ClonerAlliance Helper or OBS Studio

For Windows users, ClonerAlliance Helper or third party software like OBS, VLC, etc can be used with ClonerAlliance UHD Pro.

For Mac or Linux users, please download third party software like OBS Mac/Linux version accordingly to work with ClonerAlliance UHD Pro.

You may make a selection according to your own demand.

See details about *Install and register ClonerAlliance Helper (Windows Users)*

See details about *Install OBS Studio*

8.3 Setting for live stream in ClonerAlliance Helper (Windows)

1. Run ClonerAlliance Helper software.

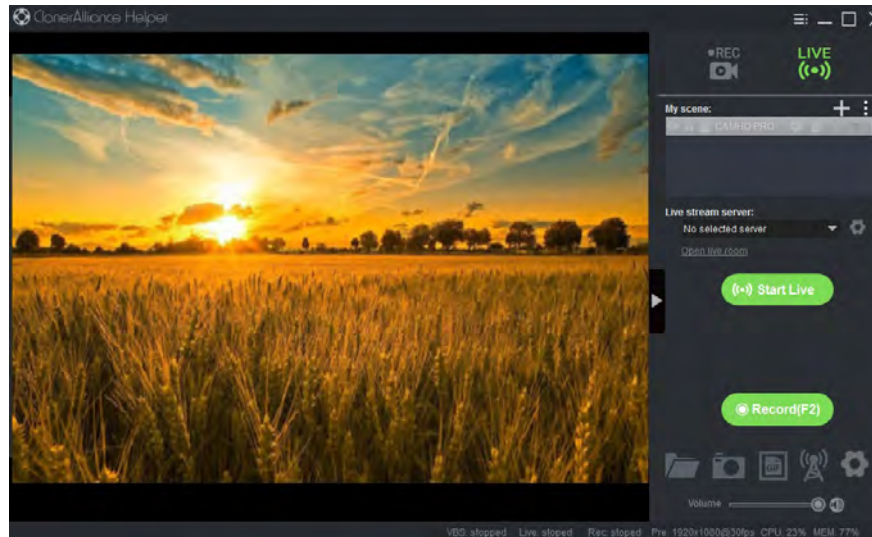

2. Please click  to setup live stream server:

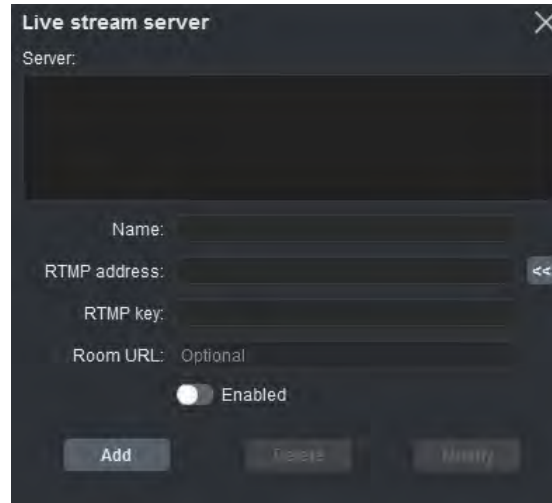

Then click "Add" to confirm settings and add a live stream server.

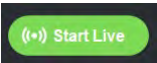
3. Please click  to start live streaming.

4. At the same time, you also can click  to capture the streaming videos.

8.4 Setting for preview video in OBS studio

1. Run Open Broadcaster Software (OBS Studio).

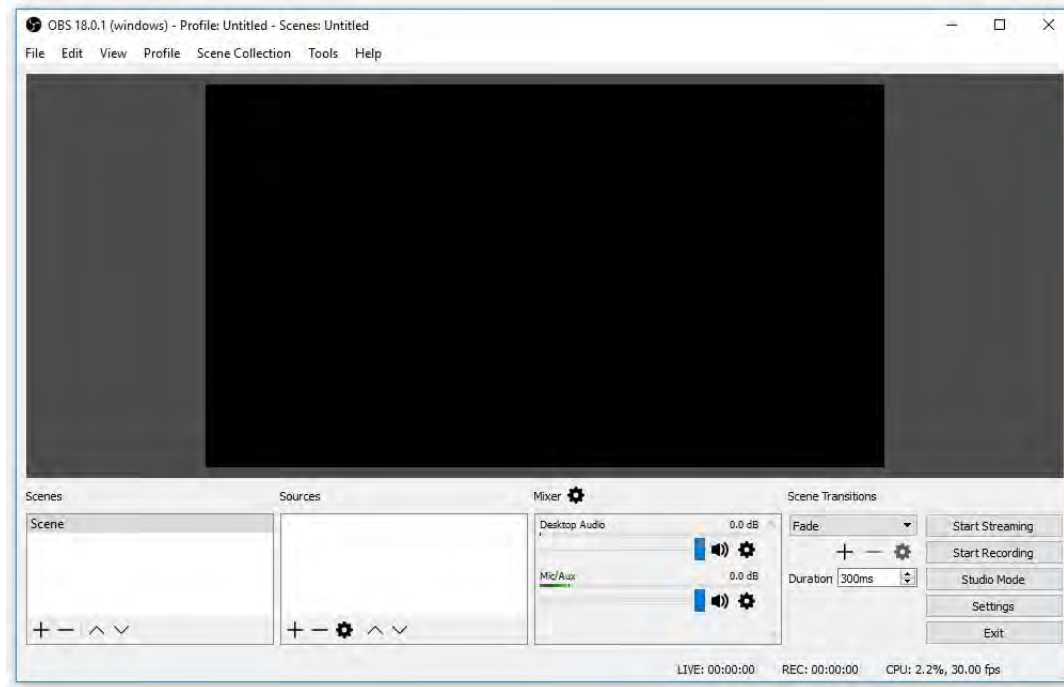

2. Please click “+” below “Sources” and select “Video Capture Device” from the pop-up menu, then click “OK” .

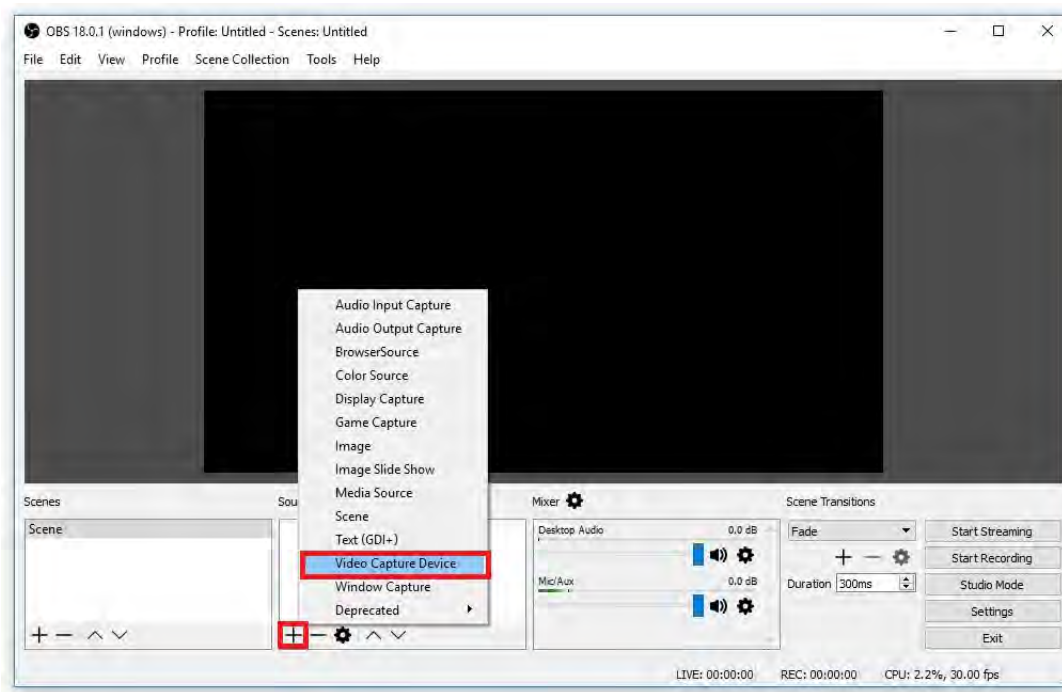

3. In the “Properties for Video Capture Device” window, select “CA-989UP UVC” in the dropdown list of “Device”, and then scroll down to the “Audio Output Mode” option. Please select “Output desktop audio (DirectSound)” in the drop-down list. Click “OK” to save the settings.

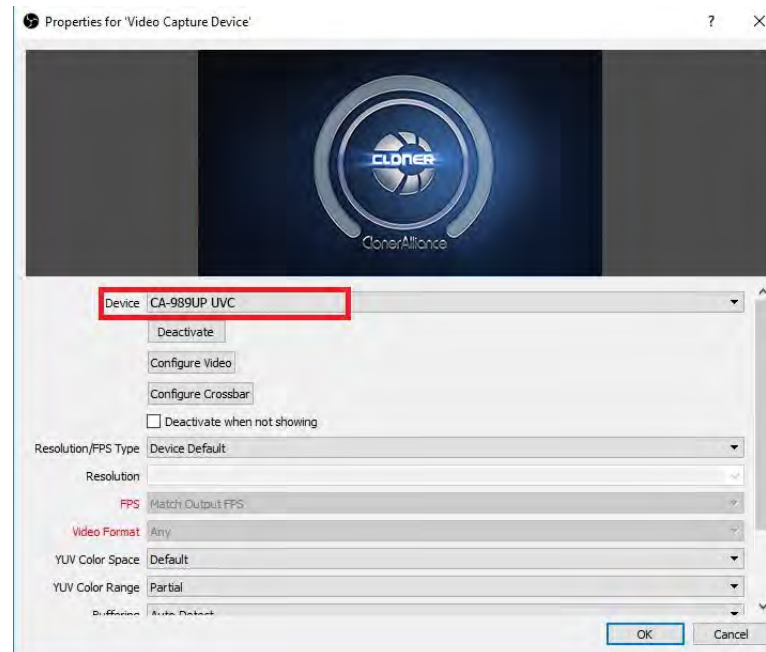

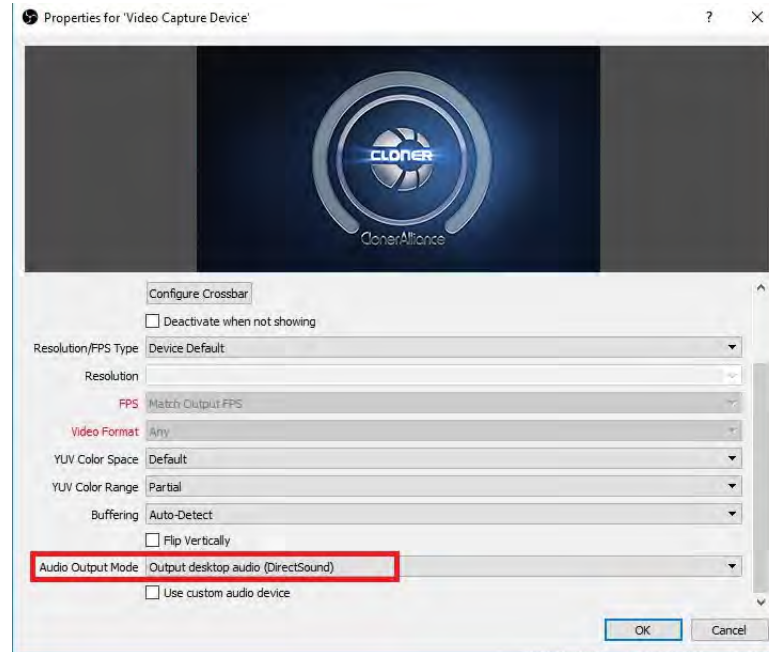

4. Now you can preview the video.

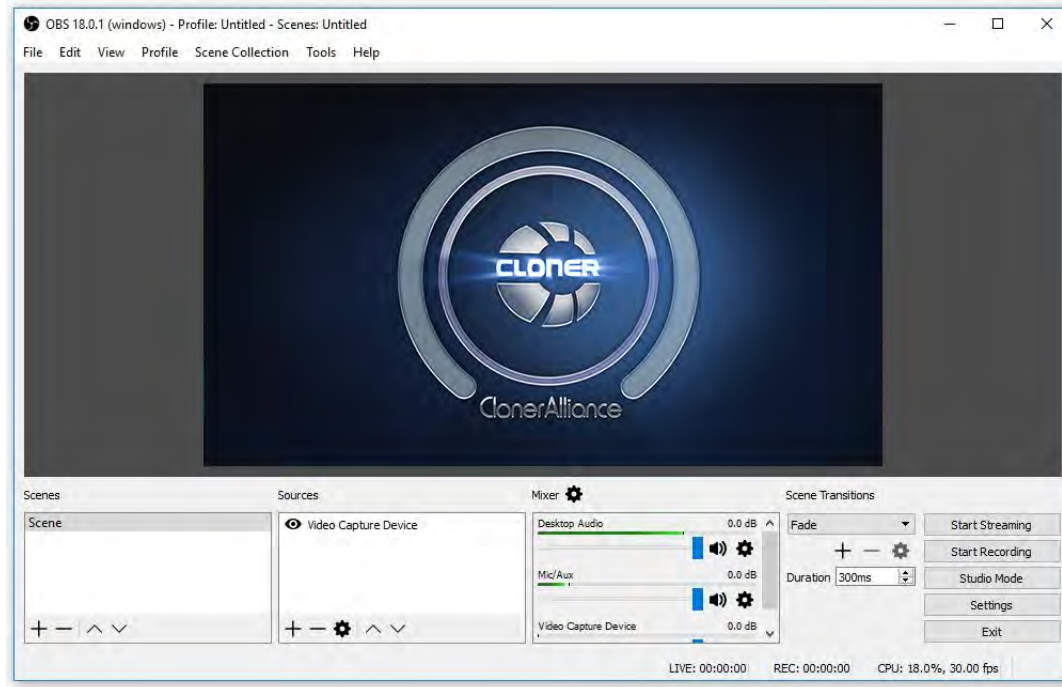

Note: Please do NOT run ClonerAlliance Helper and any Third-Party Live Streaming Software like OBS Studio at the same time. You need to run each of them separately.

FREQUENTLY ASKED QUESTIONS

You can visit <https://www.cloner-alliance.com/help/knowledgebase> at any time to view latest technical questions and answers.

Why does the “HDMI IN” field of OSD show “Please scan QR” after connecting HDMI cable with ClonerAlliance UHD Pro?

After all devices are connected properly, in the process of recording certain video sources, you may see the red “Please scan QR” in the HDMI IN field of OSD.



Please click the link below to find the answer.

<https://www.cloner-alliance.com/help/knowledgebase/why-does-the-hdmi-in-field-of-osd-show-please-scan-qr-after-connecting>

Why can't I switch H.264 to H.265?

Please note that the button is only available when USB storage device is connected.

What do different colors of the LED light on ClonerAlliance UHD Pro indicate?

Top Indicator

Color	Status
Stable BLUE	Output Resolution is 4K30
Stable GREEN	Output Resolution is 1080p60 or Below
Flashes BLUE&GREEN Alternately	No Input/Unsupported Input

Side Indicator

Color	Status
Off	No Storage Device Connected
Stable BLUE	Video Format is H.264 (AVC)
Stable GREEN	Video Format is H.265 (HEVC)

USB device is not detected and side indicator isn't on, what should I do?

Please proceed as follows:

1. Plug the USB device before powering on UHD Pro.
2. If the USB device isn't detected, keep it inserted and reboot ClonerAlliance UHD Pro.

What resolutions does ClonerAlliance UHD Pro support?

FYI. Please make sure your source device's output resolution is correct and correspondent with the supported input resolutions in this chart, ClonerAlliance UHD Pro will record accordingly.

Input Resolution	Output Resolution	Recorded Resolution
3840x2160(60Hz)	1920 x1080(60Hz)	1920 x1080(60Hz)
3840x2160(50Hz)	1920 x1080(50Hz)	1920 x1080(50Hz)
3840x2160(30Hz)	3840x2160(30Hz)	3840x2160(30Hz)
3840x2160(24Hz)	3840x2160(25Hz)	3840x2160(24Hz)
1920 x1080(60Hz)	1920 x1080(60Hz)	1920 x1080(60Hz)
1920 x1080(50Hz)	1920 x1080(50Hz)	1920 x1080(50Hz)
1080i60	1080i60	1080p30
1080i50	1080i50	1080p25
720p60	720p60	720p60
720p50	720p50	720p50
576p50	576p50	576p50
480p60	480p60	480p60

Does ClonerAlliance UHD Pro work with an over-2TB external hard drive?

Yes, ClonerAlliance UHD Pro works with an over-2TB external hard drive.

For ClonerAlliance UHD Pro, it works with all formats of USB sticks(NTFS, FAT32, exFat) and external hard drives(MBR and GPT). FYI. Due to the maximum capacity limitation of FAT32 and NTFS format, if you use an over-2TB external hard drive and don't want to partition it, please format it to exFAT, it will work. If you want to use NTFS/FAT32, please partition it first, it will work.

File system limitations:

FAT: The single file can be 2GB at most. The maximum capacity of the partition is 2GB.

FAT32: The single file can be 4GB at most. The maximum capacity of the partition is 128GB.

NTFS: The single file can be 2TB at most. The maximum capacity of the partition is 2TB.

exFAT: Theoretically, there's no limitation on the single file's size and maximum capacity of the partition.

Why does the recorded file split into multiple segments?

Using exFAT/NTFS USB storage devices, the single recorded file will be 16.7GB at most. Using FAT32 USB storage devices, the single recorded file will be 4GB at most due to the limitation of FAT32 format.

Once the recorded file size exceeds these limitations accordingly, ClonerAlliance UHD Pro will generate a new video file automatically to continue the record.(If needed, you may use bundled Windows software MP4-Cloner to combine them into one file easily.)

Note: The single file length is also limited to 3 hours. If the size of the video file has not reached 4GB/16GB but the length exceeds three hours, it will also generate a new video file.

How to record videos to the USB storage device with ClonerAlliance UHD Pro?

See details about *Record videos to the USB storage device*

How to playback the recorded video files on the USB storage device?

See details about *Playback the Recorded Media files*

Can I rename the recorded video file and still play it back with ClonerAlliance UHD Pro?

Yes, but you need to take the USB storage device out from your ClonerAlliance UHD Pro and rename the recorded files on a computer. Please be sure the file's name begins with "REC", namely, you can customize the latter part, please rename it to the format of REC_XXXXXXXXXX.mp4, then the renamed video files also can be played with UHD Pro.

FYI. If you want to rename the screenshot and still want to be able to view it on your TV through the UHD Pro, please be sure the file's name begins with "IMG", please rename it to the format of IMG_XXXXXXXXXX.jpg.

Does ClonerAlliance UHD Pro record 5.1 audio from the HDMI (AC3, DTS etc) or just 2 channels?

ClonerAlliance UHD Pro records PCM or Stereo audio format. I am sorry that it doesn't record Dolby Digital 5.1. Please adjust the audio output of your source device to PCM or Stereo before recording.

PRODUCT SPECIFICATIONS

Input	1920x1080 640x480, 720x480, 720x576, 800x600, 1024x768, 1280x720, 1280x1024, 600x1200, 1920x1080, 3840x2160(60HZ, 30HZ, 24HZ)
Output	640x480, 720x480, 720x576, 800x600, 1024x768, 1280x720, 1280x1024, 600x1200, 1920x1080, 3840x2160(30HZ, 25HZ)
Recording	Up to 3840x2160(30fps)
Output format	H.264, H.265
Video standard (input)	HDMI 2.0 standard
Input signal	HDMI, Line in, Mic
Output signals	HDMI (pass-through), USB, Line out
Max transmission bitrate	480 megabytes
Bitrate	Max: 20Mbps
Weight	8.5 oz
Dimensions	4.6 x 4.6 x 1.1 inches

AFTER SALES WARRANTY

ClonerAlliance Inc. provides 60-Day No Hassle Return(No Additional Fee) and 2-Year Replacement Warranty Service for all hardware. Please rest assured to use ClonerAlliance products.

CONTACT US

If you encounter any problem when using our products, please contact us by support@cloner-alliance.com or call 1-844-9-CLONER (toll free) and we will serve you with utmost satisfaction.

We'll offer a satisfying discount on batch purchase and affiliate program. If you are interested, please contact us by market@cloner-alliance.com.

DISCLAIMER

HDMI is a registered trademark of HDMI Licensing, LLC. USB is a registered trademark of USB Implementers Forum. HDMI and USB are registered trademarks of their respective companies. ClonerAlliance Inc. is not affiliated with those companies.



Toll free: 1-844-9-CLONER

Support Email: support@cloner-alliance.com

Market Email: market@cloner-alliance.com

www.cloner-alliance.com

Copyright ClonerAlliance Inc. All rights reserved.