SPECIFICATIONS



S/N: **944E-30**

Item Description

2/25/2019

30FT/9M- ACTIVE HDMI CABLE- HIGH SPEED w/ ETHERNET, 4K@50/60 4:4:4 (2160p), 18Gbps, 28AWG, UNIDIRECTIONAL, SNUG-TITE™ GRIP, HDR, HDCP2.2, UL CL2, PVC JKT- BLACK

- ◆ Rated Temperature (23.89 Celsius): 75 Fahrenheit
- ◆ Product Standard Certification: UL & c(UL)
- ◆ Flame Test: CL2 & FT4

Key Features

- ◆ Supports resolution up to 4K (4096x2160) @60Hz 4:4:4
- ◆ Max Bandwidth 18G
- ◆ Max Clock rate 600MHz
- ◆ UL CL2 In-Wall Rated
- ◆ HDMI Ethernet Channel and Audio Return Channel
- ◆ Blue Ray, 3D Support
- ◆ 2.2 HDCP Compliant
- ◆ CEC Support Functionality
- ◆ DTS-HD Master Audio Support
- ◆ Dolby Digital Plus Support
- ◆ Dolby True HD Support
- ◆ 32 audio channels for a multi-dimensional immersive audio experience
- ◆ Simultaneous delivery of dual video streams to multiple users on the same screen
- ◆ Support for the wide angle theatrical 21:9 video aspect ratio
- ◆ Snug-Tite plug

Application



Specifications

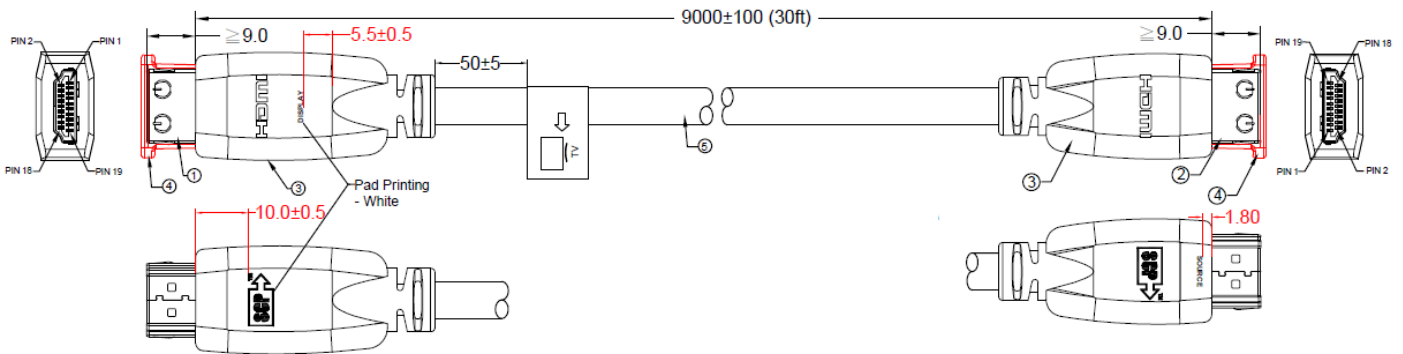

No.	Type	Description
1	Plug	Snug- Tite Gold plated W/Chipset
2	Plug	Snug- Tite Gold plated
3	Molding	PVC Black
4	Plastic cap	Transparent
5	Cable	28AWG OD7.5mm UL CL2 FT4, 30FT

Packing

- Printed Bag



- 16PCS/Carton

